

TRAK[®] TRL 1840 CSS & ProtoTRAK[®] LX3

Programming, Operating & Care Manual

Document: P/N 21210 Version: 030700
--

SOUTHWESTERN INDUSTRIES, INC.

P. O. Box 9066

Compton, CA 90224-9066

Phn: (310) 608-4422 ♦ Fax: (310) 764-2668

Plant location: 2615 Homestead Place

Rancho Dominguez, CA 90220-5610



Copyright 2000, Southwestern Industries, Inc. All rights are reserved. No part of this publication may be reproduced, stored in a retrieval system, or transmitted, in any form or by any means, mechanical, photocopying, recording or otherwise, without the prior written permission of Southwestern Industries, Inc.

While every effort has been made to include all the information required for the purposes of this guide, Southwestern Industries, Inc. assumes no responsibility for inaccuracies or omission and accepts no liability for damages resulting from the use of the information contained in this guide.

All brand names and products are trademarks or registered trademarks of their respective holders.

Southwestern Industries, Inc.
2615 Homestead Place
Rancho Dominguez, CA 90220
Phn 310/608-4422 ◆ Fax 310/764-2668
Service Department
Phn 800/367-3165 ◆ Fax 310/886-8029

TABLE OF CONTENTS

Section

1.0	Introduction	1
------------	--------------	---

Section

2.0	Safety, Specifications & Lubrication	
------------	--------------------------------------	--

2.1	Safety Publications	3
2.2	Danger, Warning, Caution and Note Labels and Notices As Used In This Manual	4
2.3	Safety Precautions	6
2.4	Specifications	8
2.5	Lubrication	9

Section

3.0	Description	
------------	-------------	--

3.1	LX3 Keyboard	11
3.2	LX3 Soft Keys	12
3.3	LX3 CRT Screen	12
3.4	LX3 Pendant Back Panel	12
3.5	TRL Switch Panel	12
3.6	LX3 Computer Cabinet	13
3.7	The TRL 1840 CSS Lathe	13

Section

4.0 TRAK TRL 1840 CSS Machine Operation

4.1	Switching the TRAK TRL On/Off	19
4.2	Switching the ProtoTRAK LX3 On/Off	19
4.3	Spindle Forward/Off/Reverse	20
4.4	Changing Spindle Speeds	20
4.5	Using the Electronic Handwheels	21
4.6	Using the Jog Stick	21
4.7	Emergency Stop	21
4.8	Tool Pedestal	22
4.9	Tail Stock	22
4.10	Coolant System	22

Section

5.0 Definitions, Terms & Concepts

5.1	ProtoTRAK LX3 Axis Conventions	23
5.2	Absolute & Incremental Reference	23
5.3	Referenced and Non-Referenced Data	24
5.4	Tool Tip Radius Compensation	24
5.5	Tool Offset	25
5.6	Connective Events	26
5.7	Conrad	26
5.8	Chamfer	27
5.9	Absolute, Tool, and Program References	28
5.10	Feedrate Conventions	28
5.11	Spindle Speed Conventions	29

Section

6.0 DRO Mode

6.1	Enter DRO Mode	31
6.2	Clear Entry	31
6.3	Inch to MM or MM to Inch	32
6.4	Reset One Axis	32
6.5	Preset	32
6.6	Reset Absolute Reference	32
6.7	Preset Absolute Reference	32
6.8	Recall Absolute Position of All Axes	32
6.9	Recall Absolute Position of One Axis	33
6.10	Change from Fine to Coarse Handwheel Resolution & Feed	33
6.11	Tool Number	33
6.12	Power Feed	33
6.13	Manual Go To	34
6.14	Return to Home	34
6.15	Do One Events	35
6.16	Tool Tip Radius Compensation in DRO Mode	37
6.17	Changing Spindle Speeds	37

Section

7.0 Program Mode

7.1	Enter Program Mode & Assign a Part Number	39
7.2	Incremental Reference Position	40
7.3	Programming Strategy and Procedures	40
7.4	Position Events	42
7.5	Drill Events	43
7.6	Bore Events	44
7.7	Turn Events	45
7.8	Arc Events	46
7.9	Cycle Events	47
7.10	Thread Event	51
7.11	Repeat Events	54
7.12	Aborting a Partially Programmed Event	55
7.13	Editing Data While Programming an Event	55
7.14	Finish Cuts	55
7.15	Sample Program	56

Section

8.0 Edit Mode

8.1	Enter Edit Mode	63
8.2	Recall and Data Correction	63
8.3	Adding an Event	65
8.4	Deleting an Event	65
8.5	Erasing a Program	65

Section

9.0 Set Up Mode

9.1	Enter Set Up Mode	67
9.2	Tool Set Up	67
9.3	A Practical Technique for Accurate Tool Setting	70
9.4	Tool Set Up When Adding or Changing Tools	70
9.5	Setting Home Position	70
9.6	Draw Part Graphics	71
9.7	Tool Path Graphics	71
9.8	Limiting Spindle Speed	72
9.9	Saving Tool Data	72
9.10	Tool Groups	72
9.11	Service Codes	75

Section

10.0 Program Run Mode

10.1	Enter Run Mode	77
10.2	Starting to Run	77
10.3	Program Run	78
10.4	Program Run Messages	80
10.5	TRAKING	80
10.6	Stop	81
10.7	Feedrate and Spindle Speed Override	81
10.8	Threading Exceptions	81
10.9	Data Errors	81
10.10	Fault Messages	82

Section

11.0 Math Help Mode

11.1	Procedure	83
11.2	Calculator-Math and Trig Procedures	85
11.3	Math Help Types	86

Section

12.0 Program In/Out Mode

12.1	Cautions About Storing & Retrieving Programs	89
12.2	Program Formats and Labeling	90
12.3	Enter Program In/Out Mode	90
12.4	Storing & Retrieving Programs from the ProtoTRAK LX3 Built-In Floppy Disk Drive	91
12.5	Backing Up Your LX3 Programs	92
12.6	Storing and Retrieving Programs through the RS232 Port - Including CAD/CAM Generated Programs	92

1.0 Introduction

Congratulations! Your TRAK TRL 1840 CSS is a unique, one-of-a-kind, machine tool that combines the simplicity of manual machining with the contouring capability of CNC turning centers.

The TRAK TRL 1840 CSS has been designed to maximize the interplay between manual and CNC machining.

- It acts like an advanced digital readout in manual machine operation.
- It acts like a turning center when programmed to do complex contouring jobs.
- And it acts with the best qualities of each when you manually feed programmed contours with the powerful TRAKing feature.

Section 2 of this manual describes the necessary SAFETY PRECAUTIONS which must be learned and followed by each operator.

Section 3 of this manual provides a brief description of the TRAK TRL 1840 CSS.

Section 4 of this manual describes the operation of the lathe.

Section 5 defines some terms and concepts useful in learning to program and operate the ProtoTRAK LX3.

The ProtoTRAK LX3 is organized into seven Modes of operation which are described in the following sections.

Section 6 DRO: Digital Readout, and powerfeed, and Do One Programs

Section 7 PROGRAM: All input in simple machinist language.

Section 8 EDIT: Program review and edit.

Section 9 SET UP: Tool information and part graphics.

Section 10 RUN: Machining the part.

Section 11 MATH HELP: Sophisticated routines to automatically calculate points of intersection, tangency, etc.

Section 12 PROGRAM IN/OUT: CAD/CAM interface, and program storage and retrieval.

2.0 Safety Specifications & Lubrication

The safe operation of the TRAK TRL 1840 CSS depends on its proper use and the precautions taken by each operator.

- Read and study this TRAK TRL 1840 CSS & ProtoTRAK LX3 Programming, Operating, and Care Manual. Be certain that every operator understands the operation and safety requirements of this machine **before** its use.
- Always wear safety glasses and safety shoes.
- Always stop the spindle and check to ensure the CNC control is in the stop mode before changing or adjusting the tool or workpiece.
- Never wear gloves, rings, watches, long sleeves, neckties, jewelry, or other loose items when operating, or around the machine.
- Use adequate point of operation safeguarding. It is the responsibility of the employer to provide and ensure point of operation safeguarding per ANSI B11.6-1984.

2.1 Safety Publications

Refer to and study the following publications for assistance in enhancing the safe use of this machine:

Safety Requirements For The Construction, Care And Use of Lathes (ANSI B11.6-1984). Available from the American National Standards Institute, 11 West 42nd Street, New York, NY 10036.

Concepts And Techniques Of Machine Safeguarding (OSHA Publication Number 3067). Available from The Publication Office - O.S.H.A., U.S. Department of Labor, 200 Constitution Avenue, NW, Washington, DC 20210.

All other regulations specific to the State in which the machine is installed.

2.2 Danger, Warning, Caution, and Note Labels and Notices As Used In This Manual

DANGER - Immediate hazards which **will** result in severe personal injury or death. Danger labels on the machine are red in color.

WARNING - Hazards or unsafe practices which **could** result in severe personal injury and/or damage to the equipment. Warning labels on the machine are gold in color.

CAUTION - Hazards or unsafe practices which **could** result in minor personal injury or equipment/product damage. Caution labels on the machine are gold in color.

NOTE - Call attention to specific issues requiring special attention or understanding.

115 Volts
230 Volts

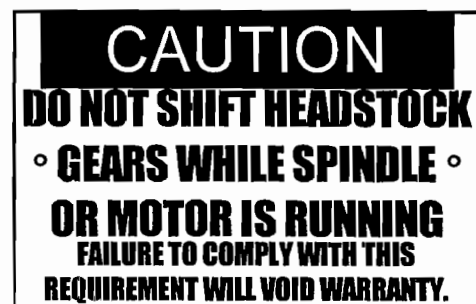
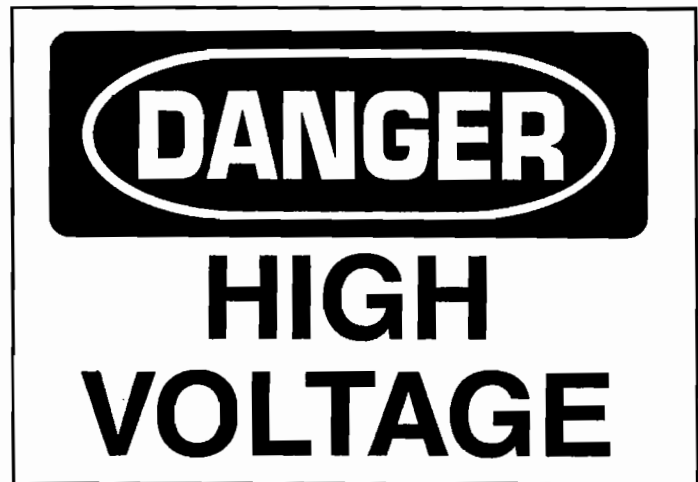

Safety & Information Labels Used On The TRAK TRL 1840 CSS Lathe

It is forbidden by OSHA regulations and by law to deface, destroy or remove any of these labels

SOUTH WESTERN INDUSTRIES
 2605 HOMESTEAD PLACE,
 RANCHO DOMINGUEZ, CA 90220



MODEL S/N

ELECTRICAL RATINGS:
 VOLTS AMPS PHASE
 Hz

FLA OF LARGEST MOTOR AMPS
 SHORT CIRCUIT INTERRUPT AMPS
 ELECTRICAL DRAWING #:

CNC CONTROL ELECTRICAL RATINGS:
 IF APPLICABLE
 VOLTS AMPS PHASE
 Hz

MACHINE (ONLY) MADE IN "XXXXXX"

Safety & Information Labels Used On The
TRAK TRL 1840 CSS Lathe
It is forbidden by OSHA regulations and by law to deface, destroy or
remove any of these labels

2.3 Safety Precautions

WARNING!

Use only chucks which are rated to the maximum RPM of the lathe.

1. Do not operate this machine before the TRAK TRL 1840 CSS & ProtoTRAK LX3 Programming, Operating and Care Manual have been studied and understood.
2. Do not run this machine without knowing the function of every control key, button, knob, or handle. Ask your supervisor or a qualified instructor for help when needed.
3. Protect your eyes. Wear approved safety glasses (with side shields) at all times.
4. Don't get caught in moving parts. Before operating this machine, remove all jewelry, including watches and rings, neckties, and any loose-fitting clothing.
5. Keep your hair away from moving parts. Wear adequate safety head gear.
6. Protect your feet. Wear safety shoes with oil-resistant, anti-skid soles, and steel toes.
7. Take off gloves before you start the machine. Gloves are easily caught in moving parts.
8. Remove all tools (wrenches, chuck keys, etc.) from the machine before you start. Loose items can become dangerous flying projectiles.
9. Never operate any machine tool after consuming alcoholic beverages, or taking strong medications, or while using non-prescription drugs.
10. Protect your hands. Stop the machine spindle and ensure that the CNC control is in the STOP mode:
 - Before changing tools
 - Before changing parts
 - Before you clear away the chips, oil or coolant. Always use a chip scraper or brush
 - Before you make an adjustment to the part, chuck, coolant nozzle or take measurements
 - Before you open safeguards (protective shields, etc.). Never reach for the part, tool, or fixture around a safeguard.

11. Protect your eyes and the machine as well. Don't use a compressed air hose to remove the chips or clean the machine (oil, coolant, etc.).
12. Stop and disconnect the power to the machine before you change belts, pulley, gears, etc.
13. Keep work area well lighted. Ask for additional light if needed.
14. Do not lean on the machine while it is running.
15. Prevent slippage. Keep the work area dry and clean. Remove the chips, oil, coolant and obstacles of any kind around the machine.
16. Avoid getting pinched in places where the spindle, carriage, cross-slide or sliding door create "pinch points" while in motion.
17. Securely clamp and properly locate the workpiece in the chuck or in the fixture. Use proper tool holding equipment.
18. Use correct cutting parameters (speed, feed, and depth of cut) in order to prevent tool breakage.
19. Use proper cutting tools for the job.
20. Prevent damage to the workpiece or the cutting tool. Never start the machine (including the rotation of the spindle) if the tool is in contact with the part.
21. Don't use dull or damaged cutting tools. They break easily and may become airborne. Inspect the sharpness of the edges, and the integrity of cutting tools and their holders.
22. Large overhangs on cutting tools when not required result in accidents and damaged parts.
23. Prevent fires. When machining certain materials (magnesium, etc.) the chips and dust are highly flammable. Obtain special instruction from your supervisor before machining these materials.
24. Prevent fires. Keep flammable materials and fluids away from the machine and hot, flying chips.
25. Never change gears when the spindle is rotating.
26. Do not rotate the spindle by hand unless the Red Emergency Stop button is pressed.

2.4 Specifications

TRL 1840 CSS

	Inch	MM
Capacity		
Height of Centers	9.0	230
Distance between centers	40.2	1000
Swing over bed	18.5	470
Swing over saddle wings	17.0	430
Swing over cross-slide	9.0	230
Cross-slide travel	13.0	330
Tool section max	1 x 1	25 x 25
Coolant	13 gal.	50 L
Bed		
Width	14.5	370
Height	13.4	340
Headstock		
Spindle nose	CAMLOCK D1-6	
Spindle through hole	2.36	60
Spindle taper	MT-6	
Taper reduction sleeve	MT-4	
Spindle dia at front bearing	3.35	85
Number of spindle speeds	infinitely variable	
Spindle speed range	Low 50 - 270	
	Medium 150 - 850	
	High 450 - 2500	
Tailstock		
Quill travel	6.3	160
Quill diameter	2.95	75
Quill taper hole	MT-5	
Motors		
Main motor	10.0 HP	
Amps, full load	36	
Phase/Hz	3/60	
Coolant pump motor	0.25 HP	

2.5 Lubrication (also see TRL 1840 CSS Installation, Maintenance, and Service Manual)

2.5.1 Headstock

Check the sight glass on the headstock periodically each day to make sure oil is being pumped to the headstock. The level of the oil in the headstock oil reservoir can be checked by the sight level located under the spindle cover. If low, fill to the sight level with Mobil DTE 24 or equivalent oil. The headstock oil reservoir holds approximately 3 1/2 gallons.

Depending on operating conditions, usually about once a year, the headstock should be drained and wiped out before adding new oil. A drain valve is located under the spindle cover. Refill the headstock with oil to the site level.

Note: The headstock oil pump runs when power is turned on. The emergency stop button will shut the pump down when it is pressed. We recommend pressing the E-Stop at the end of each working day

2.5.2 Carriage, Cross-Slide, and Ballscrews

The auto lube system provides centralized automatic lubrication for the cross slide, saddle and ballscrews. The lube pumps 2-liter reservoir is serviced with S.A.E. 30 weight oil. The pump is factory set to pump for 15 seconds every 60 minutes of spindle time. There is an internal memory on the pump so that the pump will not reset every time the spindle is turned off.

The pump output can be regulated electronically to control the pause time between pumping cycles, and the duration of the pumping cycle. The following describes the buttons used to program the lube pump. In order to modify any of the settings the spindle must be on.

INT (Interval) – this button programs the interval between pumping cycles. Each press of the button increases the interval by one minute.

DIS (Discharge) – this button programs the amount of time the pump will discharge each pumping cycle. Each press of the button increases the discharge time by one minute.

FEED – this button is used to manually feed the ways, ballscrews, and yokes.

RST – this button tells the pump to discharge for the time programmed.

2.5.3 Tail Stock

Weekly oil the tail stock through its oilers with a high grade S.A.E. 30 oil.

3.0 DESCRIPTION

3.1 LX3 Keyboard (*Figure 1*)

GO: initiates motion in Run

STOP: halts motion during Run

FEED ↑: feedrate override to increase feedrate

FEED ↓: feedrate override to decrease feedrate

MODE: to change from one mode of operation to another

INC/ABS: switches both or one axis from incremental to absolute or absolute to incremental

IN/MM: causes English to Metric or Metric to English conversion of displayed data

LOOK: displays quick graphics in program mode

SPEED ↑: SPEED override to increase RPM

SPEED ↓: SPEED override to decrease RPM

INC SET: loads incremental dimensions and general data

ABS SET: loads absolute dimensions and general data

X, Z: selects axis for subsequent commands

F/C: switches from fine to coarse or back for manual feed in DRO and TRAKing

RSTR (Restore): clears an entry, aborts a keying procedure

0-9, +/-, . : inputs numeric data with floating point format. Data is automatically + unless +/- key is pressed. All input data is automatically rounded to the system's resolution.

3.2 LX3 Soft Keys

Beneath the CRT screen are 8 keys that are not labeled. These keys are called software programmable or soft keys. A description of the function or use of each of these keys will be shown at the bottom of the CRT screen directly above each key. If, at any time, there is no description above a key, that key will not operate.

3.3 LX3 CRT Screen (*Figure 1*)

The information displayed on the CRT screen is nearly always divided into 4 sections or areas.

The top line, or status line, shows the system's current status. This includes the mode, inch or mm measurement, part numbers, servo on or off status as applicable, and fine/coarse handwheel resolution. The RPM of the spindle will also be shown here.

Beneath the status line, and filling most of the screen, is the information area. Position data, program data, graphics, etc. are shown here.

Beneath the information area is a single "conversation" line. All instructions, prompts, messages, etc. that the control needs to communicate to you are shown on this line.

At the bottom of the CRT are boxes describing the current function or use of each soft key located under the box.

3.4 LX3 Pendant Back Panel (*Figure 2*)

See Figure 2 for a description of the fuses, switches, and connectors on the pendant back panel.

3.5 TRL Switch Panel (*Figure 3*)

The Switch Panel, located on the door, contains the E-Stop button, the spindle on/off switch, and the coolant on/off/auto switch.

3.6 LX3 Computer Cabinet (Figure 4)

The computer cabinet, located inside the main electrical cabinet, contains the ProtoTRAK LX3 computer systems. See Figure 4 for a description of each connector.

3.7 The TRL 1840 CSS Lathe (Figure 5)

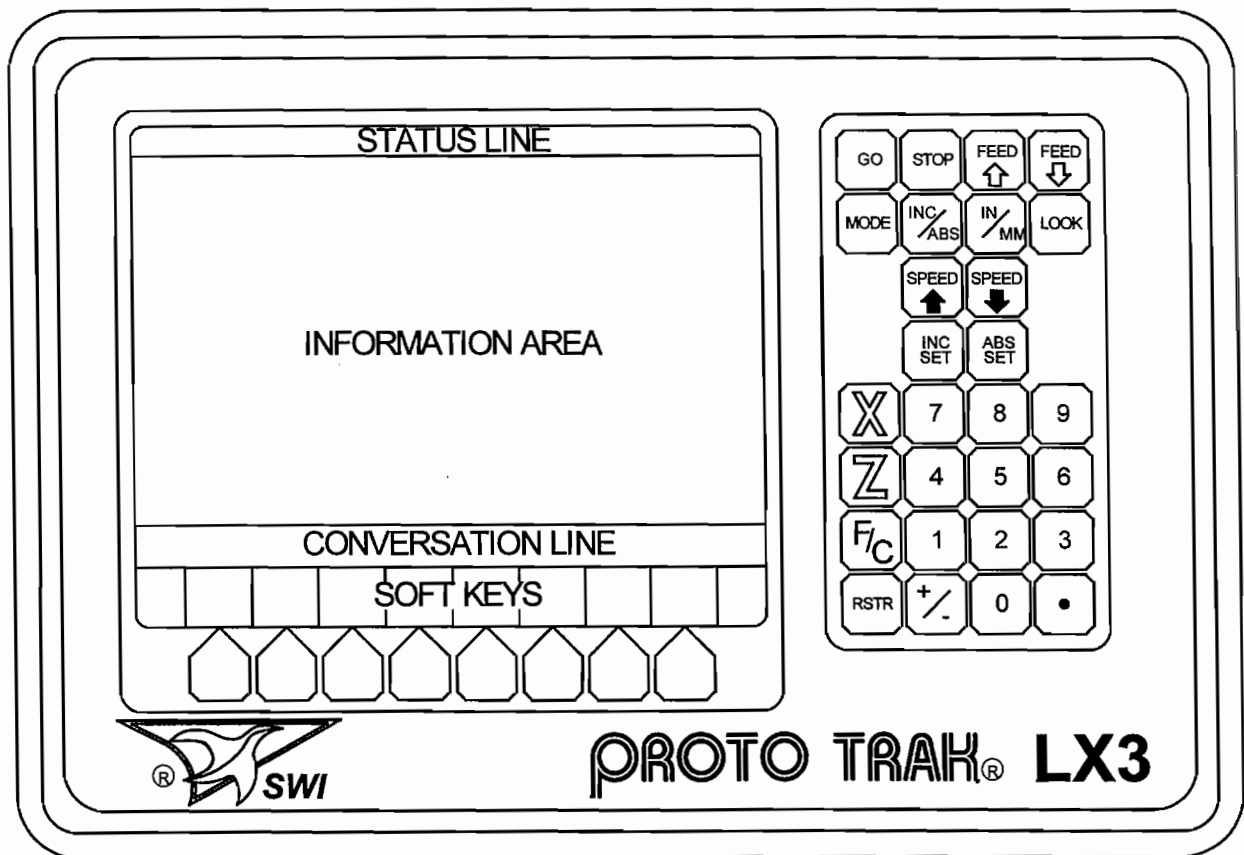

Figure 1
LX3 Pendant

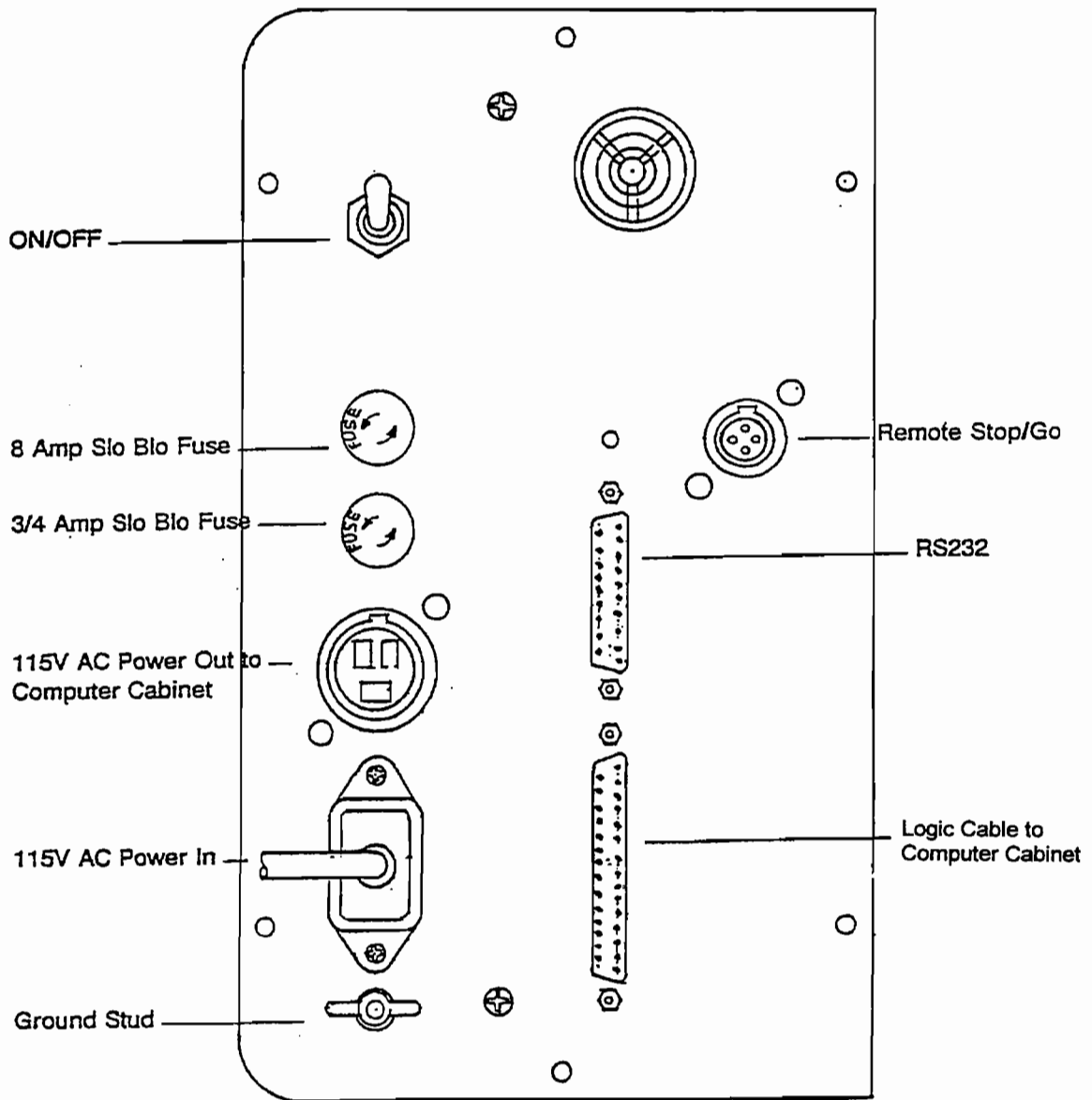

Figure 2
LX3 Pendant Back

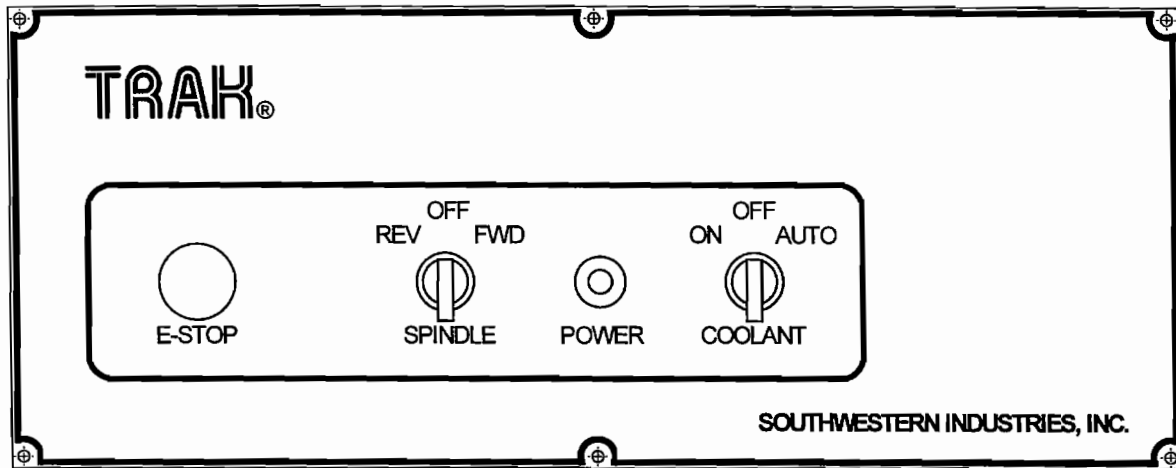

Figure 3
TRL Switch Panel

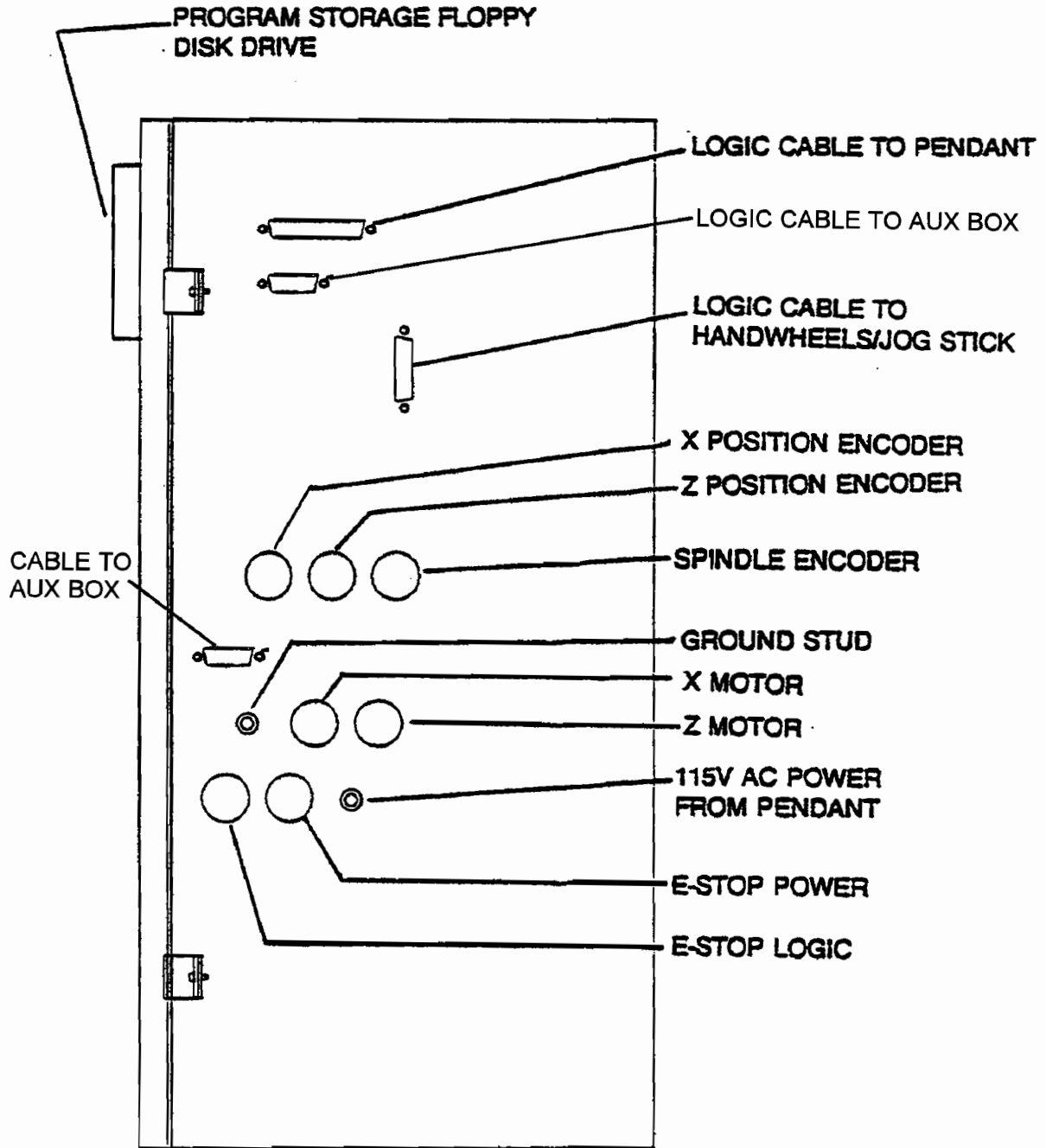

Figure 4
Computer Cabinet

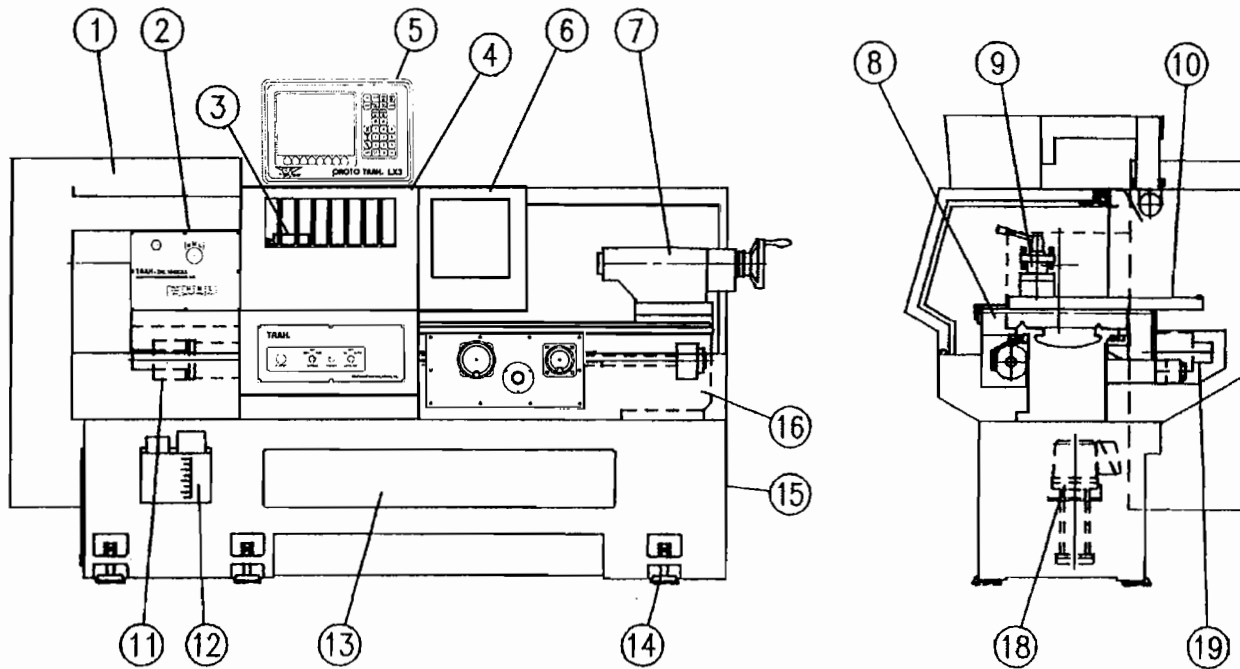

Figure 5

Item No.	Description
1	Computer Cabinet
2	Headstock
3	Chuck
4	Door
5	Control
6	Viewing window
7	Tailstock
8	Carriage
9	Tool post
10	Crossslide
11	Z-axis motor
12	Lube pump
13	Chip pan
14	Leveling pad
15	Base
16	Bed
17	Coolant pump
18	X-axis motor
19	Apron
20	Door switch panel

4.0 TRAK TRL 1840 CSS Machine Operation

4.1 Switching the TRAK TRL 1840 CSS On/Off

Power to the TRAK TRL 1840 CSS is turned on through the main on/off switch located on the back of the main electrical cabinet.

4.2 Switching the ProtoTRAK LX3 On/Off

To turn the ProtoTRAK LX3 on, move the toggle switch on the display back panel to the Up position.

The display will read "Loading LX3", indicating that the system's operating software is being loaded from its floppy disk to its internal memory. This takes about one minute. When complete, the screen will show:

SELECT MODE							
DRO	PROG	EDIT	SETUP	RUN	MATH HELP	PROG IN/OUT	

Select the mode of operation by pressing the soft key beneath the labeled box.

It is recommended that the system be switched on only once each day, and then turned off at night.

If the system is not used (either by a keystroke or by counting) for 20 continuous minutes, the CRT will turn itself off. Press any key to bring the screen back to its previous display. The key you press will be ignored except to turn the screen on.

Note: When you turn the ProtoTRAK LX3 off, always wait a few seconds before turning it back on.

4.3 Spindle Forward/Off/Reverse (Figure 3)

The Spindle Forward/Off/Reverse switch is located on the right side of the E-stop on the door.

Turn it to the right to activate the spindle in the forward (spindle rotates counter-clockwise) direction.

Turn it to the left to activate the spindle in the reverse (spindle rotates clockwise) direction.

Off is the center.

4.4 Changing Spindle Speeds

WARNING

DO NOT SHIFT HEADSTOCK GEARS WHILE THE SPINDLE OR MOTOR IS RUNNING.

The following table is located on the TRL 1840 CSS headstock label plate:

Speed Range	H	M	L
RPM	450 - 2500	150 - 850	50 -270

To select the proper spindle R.P.M., locate the speed you wish, shift the lever to the appropriate position.

Note: You may have to rotate the spindle a little by hand to help engage the gears. Only do this with the Emergency Stop switch pushed in.

4.5 Using the Electronic Handwheels

The X (cross-slide), and Z (carriage) handwheels are located on the apron. They are electronic, that is they are not mechanically connected to the machine, but rather create electronic signals to command the servo motors to drive the ball screws which, in turn, drive the carriage and cross-slide.

The handwheels will not work unless the ProtoTRAK LX3 is turned on, and in the DRO mode, or in the Set Up mode, or in the TRAKing feature in the Run mode.

Counterclockwise motion on the Z handwheel moves the carriage left 0.40" per revolution in .002" increments in coarse feed, or .10" per revolution in .0005" increments in fine feed. See Section 6.10 to switch from coarse to fine and back.

Clockwise motion on the X handwheel moves the cross-slide away from you .10" per revolution in .0005" increments (on diameter) in coarse feed, or .02" per revolution in .0001" increments in fine feed. See Section 6.10 to switch from coarse to fine and back.

4.6 Using the Jog Stick

The jog stick is located on the carriage apron in between the X and Z handwheel. The jog stick will operate only if the ProtoTRAK LX3 is turned on, and in the DRO mode or Set-Up mode, or in the TRAKing feature in the Run mode.

Move the stick left or right to move the carriage left or right at 150 inches per minute. Move the stick up or down to move the cross-slide in or out at 100 inches per minute of diameter, or 50 inches per minute of actual cross-slide speed.

4.7 Emergency Stop

There is one red Emergency Stop (E-STOP) mushroom button. It is located on the door to the left of the spindle on/off switch. Press the button to shut off power to the spindle motor, carriage and cross-slide drive motors and headstock oil pump. Rotate the switch to turn it off only when the emergency condition has been rectified.

4.8 Tool Pedestal

The tool pedestal is held to the top of the cross-slide with four bolts with T nuts.

A T-slot is machined on top of the pedestal that will accommodate most common tool posts.

4.9 Tail Stock

The tail stock may be positioned along its V-way by releasing the lock with the lock handle. The tail stock can also be locked with the nut located on the operator side of the tail stock. The quill may be locked with the quill lock at any position along its travel. The tail stock may be centered with the spindle through the set screw on the tail stock base.

4.10 Coolant System

The coolant piping system is mounted to the rear of the saddle with two screws. A 1/2 inch diameter hose connects the piping to the pump and reservoir located in the right pedestal base (see Figure 5). Access is through the right side through a back access panel. The reservoir holds 13 gallons of coolant and may be filled through the access, or by pouring the coolant into the chip pan.

The coolant pump (and therefore the flow) may be turned on, off or on automatic with a switch located on the right side of the door. A nozzle on the piping allows you to regulate the flow. The automatic feature turns the coolant on in Run mode automatically when the go button is pushed, or when in TRAKing mode. In DRO mode the auto coolant comes on whenever the spindle is turned on.

5.0 Definitions, Terms & Concepts

5.1 ProtoTRAK LX3 Axis Conventions

Z Axis: positive Z axis motion is defined as the carriage moving to the right when facing the lathe. Measurement away from the chuck is positive on the workpiece.

X Axis: positive X axis motion is defined as the cross-slide moving toward you. Measurement away from the part centerline and toward you is positive on the workpiece. All X motion is displayed as diameter (not radius) dimensions.

5.2 Absolute & Incremental Reference

The ProtoTRAK LX3 may be programmed and operated in either (or in a combination) of absolute or incremental dimensions. An absolute reference from which all absolute dimensions are measured (in DRO, and program operation) can be set at any point on or even off the workpiece.

To help understand the difference between absolute and incremental position, consider the following example:

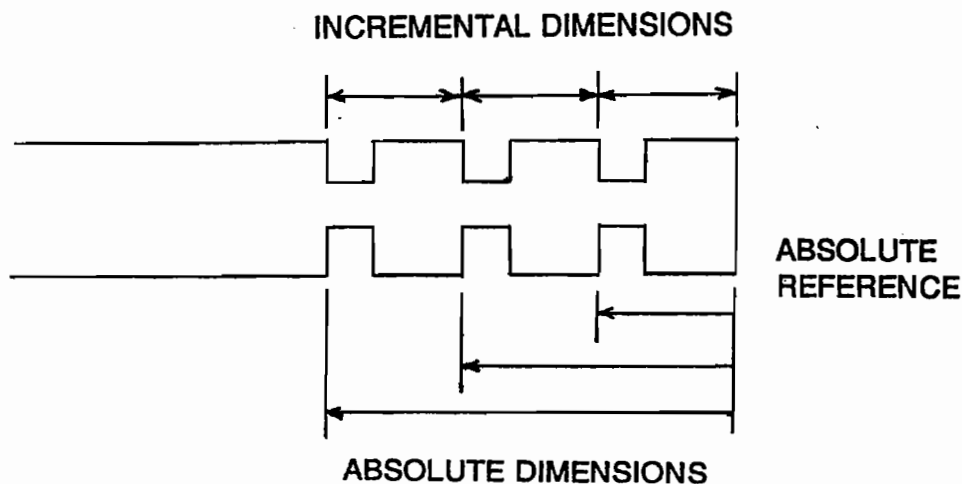

5.3 Referenced and Non-Referenced Data

Data is always loaded into the ProtoTRAK LX3 by using the INC SET or ABS SET key. X, Z positions are referenced data. In entering any X, or Z position data, you must note whether it is an incremental or absolute dimension and enter it accordingly. All other information (non-referenced data), such as tool offset, feedrate, etc. is not a position and may, therefore, be loaded with either the INC SET or ABS SET key. This manual uses the term SET when either INC SET or ABS SET may be used interchangeably.

5.4 Tool Tip Radius Compensation

When turning along the side of a part (constant X), or along the face (constant Z), the tool tip radius is not particularly important. However, as soon as you begin to machine a taper or contour, the tool tip radius has a substantial impact.

Consider the drawing below. If you had an infinitely sharp tool (no tool tip radius), assume its point was at X_0, Z_0 . Another tool with a tool tip radius of R_1 and another of R_2 are also shown. Note that all three positioned as shown have the same X contact (X_0, X_1, X_2) and if moved sideways, would cut the same diameter. Likewise, they all have the same Z contact, and if moved in would cut the same face length. However, if moved on a 45 degree taper (or any other angle) so that the cutting point was in the middle of the radius, the three tools would cut or contact along much different lines.

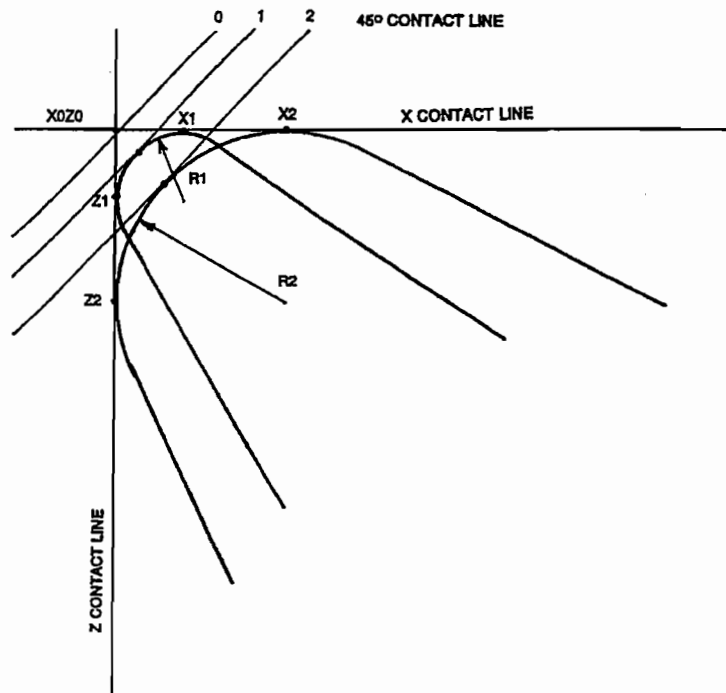

5.5 Tool Offset

When you define the shape of the part to be turned, you must also specify where the tool should be relative to the part. This is done by looking along the direction of the tool motion and declaring whether the tool is to the right or left of the part.

Examples of tool left are:

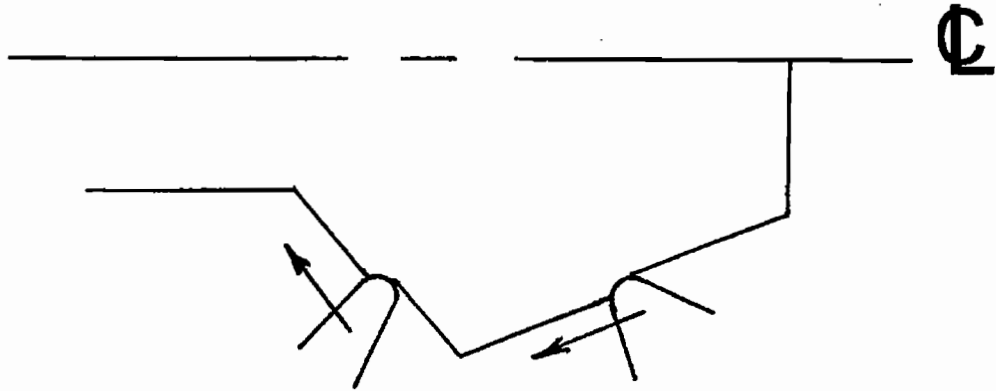

Examples of tool right are:

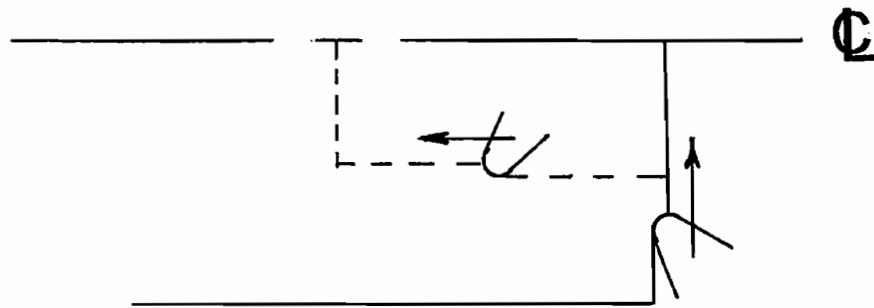

Tool center may be programmed for special circumstances where you wish to ignore the effects of tool geometry and radius.

5.6 Connective Events

Connective events occur between two turning events (either Turn or Arc) when the X and Z ending points of the first event are in the same location as the X and Z starting points of the next event. In addition, the tool offset and tool number of both events must be the same.

5.7 Conrad

Conrad is a unique feature of the ProtoTRAK that allows you to program a tangentially connecting radius between connective events.

For the figure below, you simply program a Turn event from X1, Z1 to X2, Z2 with tool left offset, and another Turn event from X2, Z2 to X3, Z3 also with tool left offset. During the programming of the first Turn event, the system will prompt for Conrad at which time you input the numerical value of the tangentially connecting radius ($r=k$). The system will calculate the tangent points T1 and T2, and direct the tool cutter to move continuously from X1, Z1 through T1, $r=k$, T2 to X3, Z3.

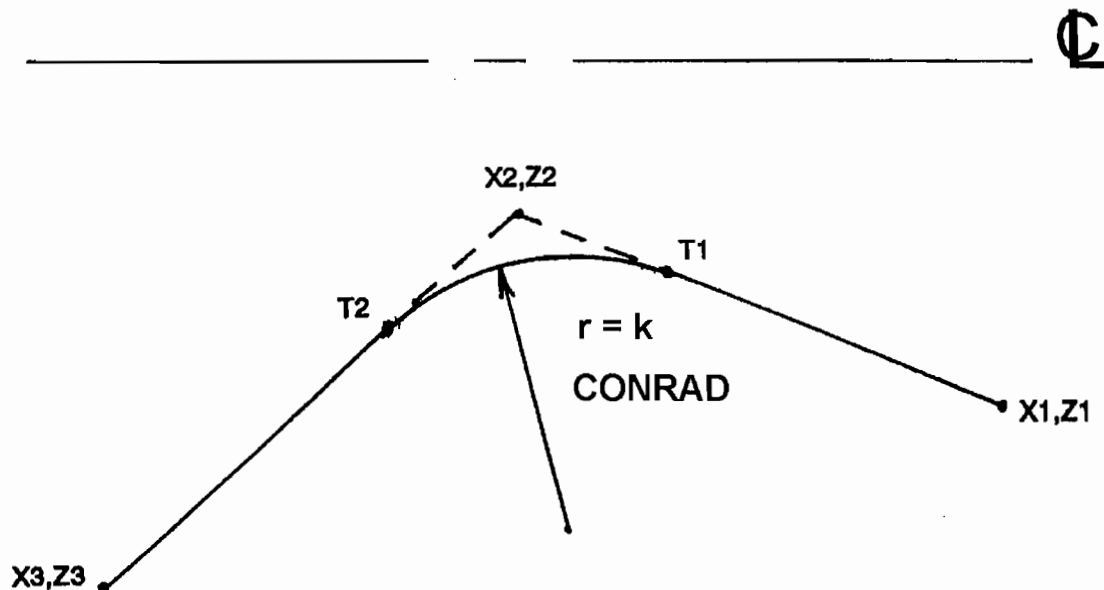

For the figure below, you program an Arc event from X1, Z1 to X2, Z2 with tool offset left, and another Arc event from X2, Z2 to X3, Z3 also with tool offset left. During the programming of the first Arc event, the system will prompt for Conrad at which time you input the numerical value of the tangentially connecting radius $r=k3$. The system will calculate the tangent points T1 and T2 and direct the tool cutter to move continuously from X1, Z1 through T1, $r=k3$, T2 to X3, Z3.

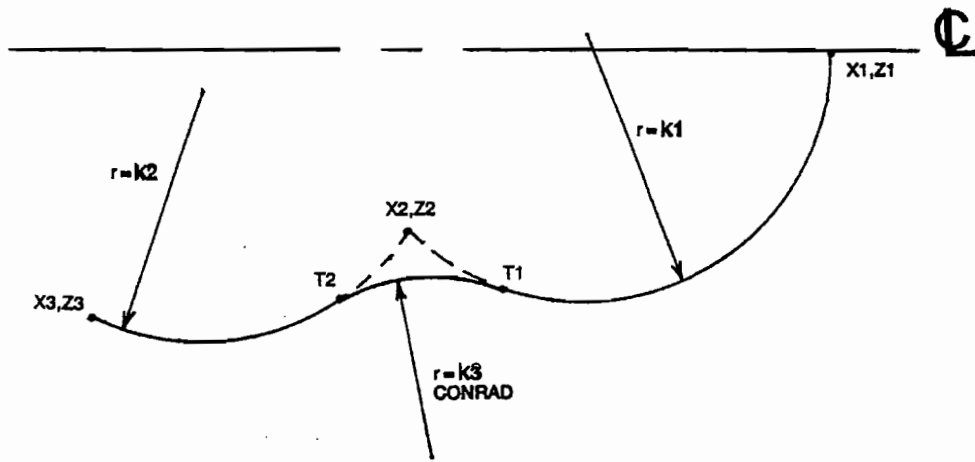

Note: Conrad must always be the same as or larger than the tool radius for inside corners. If conrad is less than the tool radius, and an inside corner is machined, the ProtoTRAK LX3 will ignore the Conrad.

Note: If you program an arc using Conrad rather than an ARC, never use a Conrad whose radius is as large or larger than the length of either line connected by the Conrad plus the tool tip radius. In the figure below, R plus the tool nose radius must be less than the programmed line ab or bc; otherwise, program the arc with an ARC Event.

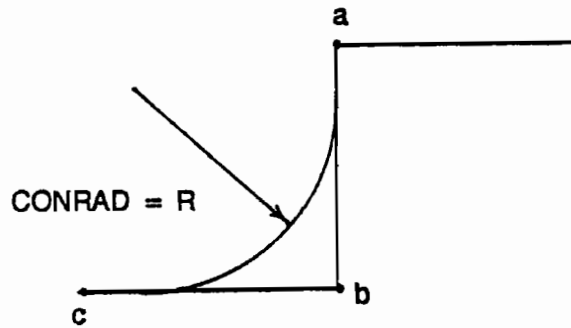

5.8 Chamfer

The ProtoTRAK LX3 also allows for easy chamfer input. A chamfer may be programmed between two turn events, two arcs, or a turn and an arc.

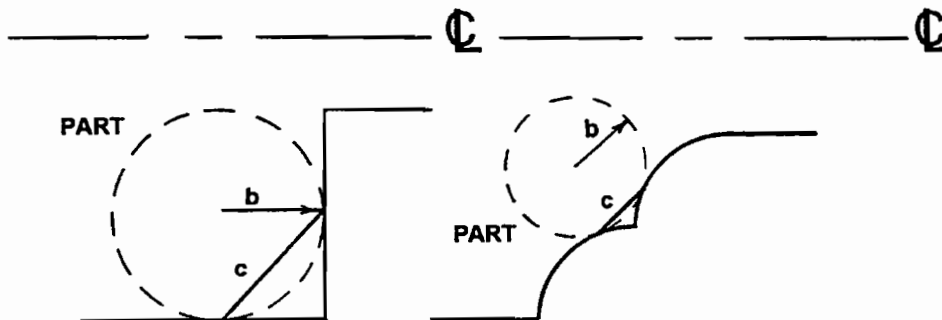

In both cases above a chamfer programmed with dimension b will cut a chamfer along line c.

5.9 Absolute, Tool, and Program References

When you operate a lathe, what you are interested in is where your tool is relative to the workpiece. However, what the LX3 monitors is how far the carriage and cross-slide move. This creates two problems.

The first has to do with using more than one tool. When you change tools, the tip on one will, most likely, not be in the same position relative to the part as the previous tool. Just changing the tool doesn't move the carriage or cross-slide, so the LX3 doesn't know that the new tip isn't where the other was. Obviously, what's needed is for you to tell the LX3 what the differences (or offsets) are from tool to tool (this is done in the Set Up Mode), and to always tell the control which tool you are using at any given time.

The second problem has to do with establishing the machine and part reference. When you turn the TRAK TRL and ProtoTRAK LX3 on, they have no idea where the carriage, cross-slide, or tool tip are. They only know how far they have moved since the last input reference (all references are lost when the control is turned off). Also, if you are going to turn a part, the control has no idea where you have chucked it. Is it sticking out of the chuck a little? A lot? What you need to do is select a tool--and always tell the control which one--and tell the LX3 where that tool is, relative to the workpiece.

In general, most programs and parts will have their centerline as the absolute zero reference in the X axis. For the Z axis, two handy references are the end of the part (generally after it has been faced), or any face of the chuck.

5.10 Feedrate Conventions

Carriage feedrate (Z motion) and cross slide feedrate (X motion) may, in most cases, be input directly as inches per minute (ipm) or as inches per revolution (ipr) of the spindle. The relationship between these is:

$$\text{ipm} = \text{ipr} \times \text{RPM}$$

or
$$\text{ipr} = \text{ipm}/\text{RPM}$$

Math Help 30 will calculate these values for you.

All feedrates must be programmed between 0.100 and 100 ipm (2.5 - 2500 mm/min) or between 0.001 and 0.099 ipr (0.025 and 2.5 mm/rev)

5.11 Spindle Speed Conventions

For programmed parts, spindle speed may be set as direct RPM or as a surface speed in surface feet per minute (SFM) or surface meters per minute (SMM).

The relationship between RPM and SFM is

$$\text{SFM} = \frac{\text{RPM} \times \text{Diameter} \times \pi}{12}$$

or $\text{SFM} = 0.26 \times \text{RPM} \times \text{Diameter}$ (in inches)

For example, when you are cutting at a diameter of 3 inches and a RPM of 600, then your SFM would be $0.26 \times 600 \times 3 = 468$. Math help 31 will calculate RPM or SFM for you.

Surface speed is the relative speed between the workpiece and the tool during a cut. That is, it is the speed that the workpiece passes across the tool.

Notice in the formula above that if you wanted the SFM to be constant during the cut you would have to change RPM as the tool moved to a different diameter - for example while facing.

When you program the spindle speed as SFM in the program mode the TRAK LX3 will assume that you want to maintain constant surface speed (CSS) and will automatically vary the spindle RPM to maintain the program value.

Note that if you program with constant surface speeds and inch per revolution feeds, then not only does the spindle RPM increase as you face cut towards the centerline but the cross slide will move at a faster rate as well.

6.0 DRO Mode

The ProtoTRAK LX3 operates in DRO Mode as a sophisticated 2-axis digital readout with jog (through the jog stick), power feed capability, and the manual Go To Function.

6.1 Enter DRO Mode

Press **MODE**, select **DRO** soft key. The CRT screen will show:

DRO	TOOL #1	RPM	COARSE INCH	> STATUS				
X	0.0000	INC		> INFORMATION				
Z	0.0000	INC						
				> CONVERSATION				
	POWER FEED	DO ONE	TOOL #	MANUAL GO TO	RETURN HOME	SPIN SPEED	RETURN	> SOFT KEYS

6.2 Clear Entry

Press **RSTR**, then re-enter all keys.

6.3 Inch to MM or MM to Inch

Press **IN/MM** and note CRT screen status line.

6.4 Reset One Axis

Press X or Z, **INC SET**. This zeros the incremental position in the selected axis.

6.5 Preset

Press X or Z, numeric data, **INC SET** to preset selected axis.

6.6 Reset Absolute Reference

Press X or Z, **ABS SET** to set selected axis absolute to zero at the current position. See 6.8 and 6.9 to display this data.

Note: This will also reset the incremental dimension if the absolute position is being displayed when it is reset.

6.7 Preset Absolute Reference

Press X or Z, numeric data, **ABS SET** to set the selected axis absolute to a preset location for the current machine position. See 6.8 and 6.9 to display this data.

Note: This will also reset the incremental dimension if the absolute position is being displayed when it is preset.

6.8 Recall Absolute Position of All Axes

Press **INC/ABS**. Note the dimension for each axis is labeled **INC** or **ABS**. Press **INC/ABS** again to revert to the original reading.

6.9 Recall Absolute Position of One Axis

Press **X** or **Z**, **INC/ABS**. Note the INC or ABS label for each axis. Repeat to get selected axis back to original reading.

6.10 Change From Fine to Coarse Handwheel Resolution and Feed

Press the **F/C** key to switch back and forth from fine to coarse.

	Resolution	Travel/Revolution
X Fine	.0001"/.005mm	.02"/1mm
Coarse	.0005"/.02mm	.10"/4mm
Z Fine	.0005"/.02mm	.10"/4mm
Coarse	.002"/.05mm	.40"/10mm

6.11 Tool Number

As discussed in Section 5.8, it is always necessary to tell the ProtoTRAK LX3 which tool number you want to use. This is because you want the readout to represent where the tool tip is (which changes from tool to tool), not where the carriage and cross-slide are.

Each time you change tools in the DRO mode, it is mandatory that you press the **TOOL #** soft key (the conversation line will show the current tool number), input the correct tool number and **SET**. Of course, it is also necessary that the LX3 know what the offset differences are from tool to tool which is explained in Section 9.2.

6.12 Power Feed

The servo motors can be used as a power feed for the carriage or cross-slide.

- a. Press the **PWR FEED** soft key.
- b. The conversation line will read "Power Feed 10 ipm indicating the status and feed rate. To powerfeed in ipr press the ipr soft key. This key will toggle between ipm and ipr. The ipr default is 0.010".

- c. Press **FEED** ↑ or **FEED** ↓ to adjust the feedrate from 1 ipm to 100 ipm or 0.001 and 0.099 ipr. See Math Help 30 (section 11.3F) to determine the proper feedrate in ipm if you know the inch per revolution feed.
- d. Press **X** or **Z**, the dimension you wish to move to, and **INC SET**.
- e. Press **GO** to begin power feed.
- f. Press **STOP** to halt power feed for any reason. Press **GO** to resume.
- g. When the movement is complete, the system will revert to normal DRO operation.

6.13 Manual Go To

The Manual Go To feature allows you to input an absolute position in X and/or Z, where the ProtoTRAK LX3 will disable the electronic handwheels and/or jog stick. In other words, it creates a barrier that the tool tip cannot move past. This allows you to move to a position without slowing way down to prevent overshoot. For example, in making several turning passes to a prescribed shoulder dimension.

To input a Go To position, press the **Manual Go To** soft key. The conversation line will show the current X and Z Go To position or barrier. Press **X** or **Z**, the new position you wish, and **SET**. Move the axis with the handwheel or jog stick and it will automatically stop at the position. You may move in the opposite direction away from the Go To position.

6.14 Return to Home

At any time during manual DRO operation you may automatically move the tool tip to your home location in X and Z by pressing the **RETURN HOME** soft key. When you do, the conversation line will read "Check Tool then press GO." Make sure your tool and its path is clear and press the **GO** key. When you do, the carriage and cross-slide will move at rapid speed to your X and Z home position. Home position is established in the Set Up Mode.

6.15 Do One Events

The purpose of the Do One Events is to allow you to make simple chamfer, taper, radius, and fillet moves, one at a time, within the DRO Mode and without the need for creating an entire program.

When you select the **DO ONE** soft key from Section 6.1, the conversation line and soft keys will read:

SELECT							
TAPER	RADIUS	FILLET					RETURN

6.15.1 Taper Do One

When you select the **TAPER** soft key, the display will read:

TAPER ANGLE = 45.0							
							RETURN

The system defaults to a positive 45 degree taper angle for a convenient chamfer. If this is the angle you wish, acknowledge so by pressing **SET**. You may specify any other angle by inputting the number and pressing **SET**. The conversation line will be back lit when you press **SET**.

Turning the Z handwheel counterclockwise, or the X clockwise, will move the tool from Point A (where you are), towards or past Point B as long as you turn the handwheel (see below).

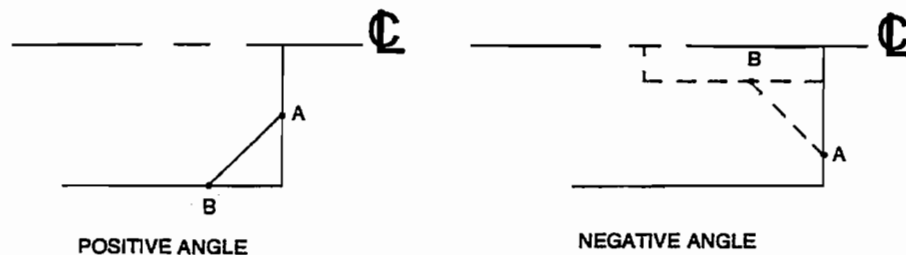

Press **RETURN** to revert back to normal DRO operation.

6.15.2 Radius Do One

When you select the **RADIUS** soft key, the display will read:

RADIUS R =							
							RETURN

Input and **SET** the radius you want through the keyboard. The radius may be positive or negative.

Turning the Z handwheel counterclockwise, or the X clockwise will move the tool from Point A (where you are), towards Point B (see below). The tool will automatically stop when you reach B.

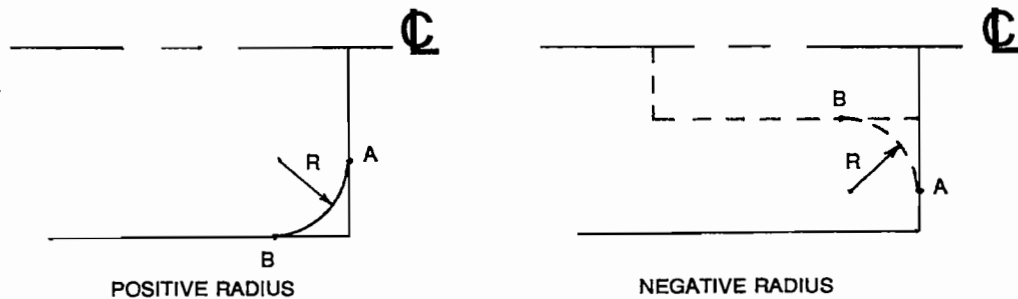

Press **RETURN** to revert back to normal DRO operation.

6.15.3 Fillet Do One

When you select the **FILLET** soft key, the display will read:

FILLET R =							
							RETURN

Input and **SET** the fillet radius you want through the keyboard. The radius may be positive or negative.

Turning the Z handwheel counterclockwise, or the X clockwise will move the tool from Point A (where you are), towards Point B (see below). The tool will automatically stop when you reach B.

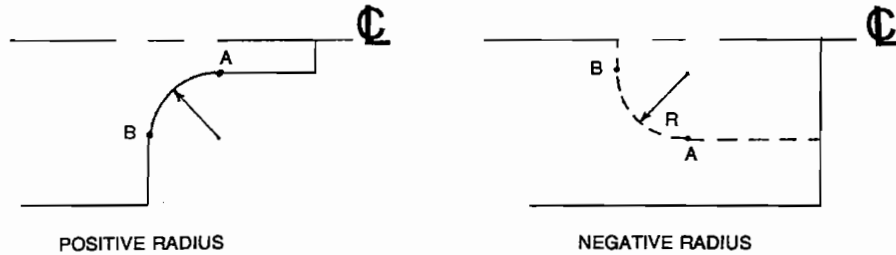

Press **RETURN** to revert back to normal DRO operation.

6.16 Tool Tip Radius Compensation in DRO Mode

As mentioned in Section 5.4, the tool tip radius is not important when you are turning along the side of a part (moving only Z), or along the face (moving only X). And in manual operation in the DRO Mode, these are the only motions which you can do. It's just not possible to move X and Z simultaneously with both hands along a precisely coordinated path.

Therefore, even if your tool has a radius, the DRO will display point X0, Z0 in the figure in Section 5.4. In other words, it will display the X and Z contact line positions which is where the tool will cut when you move either of the handwheels.

In Do One operation the tool is moved simultaneously in both the X and Z axes, but the readout still refers to point X0, Z0 in the figure in Section 5.4. This theoretical point will be driven through the taper or radius. As a consequence, if the tool tip radius is large, you may not machine the exact dimension you expect. These errors will generally be insignificant and can be eliminated all together by using a full program (see Section 7).

6.17 Changing Spindle Speed

The programmed spindle speed in RPM or surface speed in surface feet per minute (SFM) or surface meters per minute (SMM) is shown in the status line. Pressing the SPIN SPEED soft key can modify the speed. The conversation line will show the current speed. Check to make sure you are in the proper

gear range. Then input the speed you wish and press INC SET to program RPM or ABS SET to program SFM. You may do this procedure while the spindle is running or still. *(NOTE: the spindle must be turned off to change the gear speed range.)* If you do input a speed that is beyond the available range for the gear speed range that you have selected, the spindle will default to the minimum or maximum of the range and flash that RPM display in the status line.

7.0 PROGRAM Mode

7.1 Enter Program Mode and Assign a Part Number

Press **MODE**, select **PROGRAM** soft key. For a new program to be written, there cannot already be a program in the active or current program memory.

If a program does not already exist when you enter the Program Mode, the conversation line will read "Program Part Number." Enter the part number (up to 8 digits) and press **INC SET** or **ABS SET**.

Note: It is not necessary to enter a part number. If none is entered and the INC SET or ABS SET button is pushed, the system will assume a part number 0.

If there is already a program when the Program Mode is entered, the last event of this program will appear on the screen. Additional events may be added after the last event of this program. It will be necessary to erase this program first before creating a new program. The procedure to erase a program in order to create a new program is found in Section 8.5. The procedure to save a program for future use before erasing is found in Section 12.

When a new Part Number (for a new program) has been entered, the display will show the Select Event screen:

PROG P/N 12345				INCH				> STATUS
				EVENT 1				> INFORMATION
SELECT EVENT								> CONVERSATION
POSN	DRILL	BORE	TURN	ARC	CYCLE	THREAD	REPEAT	> SOFT KEYS

7.2 Incremental Reference Position

When X and Z data for the beginning position of any event are input as incremental data, this increment must be measured from some known point in the previous event. Following are the positions for each event type from which the incremental moves are made in the subsequent event:

POSITION: X and Z programmed

DRILL: X = 0 ABS, Z FINAL and Z RAPID programmed

BORE: X, Z FINAL, and Z RAPID programmed

TURN: X END and Z END programmed

ARC: X END and Z END programmed

CYCLE: the last X and Z programmed

REPEAT: The appropriate reference position for the event prior to the first event which was repeated.

THREAD: The X END and Z END programmed

For example, if an ARC event followed a TURN event, a 2.0 inch incremental Z BEG would mean that in the Z direction the beginning of the ARC event is 2.0 inches from the end of the TURN event.

7.3 Programming Strategy and Procedures

The ProtoTRAK LX3 makes programming easy by allowing you to program the actual part geometry as defined by the print. The Select Event screen (7.1) is basically a list of all the types of geometry.

The basic strategy is to select the soft key event type (geometry) and then follow all instructions in the conversation line. When an event is selected, all the prompts which need to be input will be shown on the right side of the information area. The first prompt will be highlighted and also shown in the conversation line. Input the dimension or data requested and press **INC SET** or **ABS SET**. For X or Z dimension data it is very important to properly select **INC SET** or **ABS SET**. For all other data either **SET** will do. As data is being entered it will show in the conversation line. When **SET**, the

data will be transferred to the information area, and the next prompt will be shown in the conversation line.

You may press the **DATA FWD** or **DATA BACK** soft keys to go back to edit any data within an event. Simply shift forward or back to get the prompt in the conversation line and reinput the data. At any time before the event is complete you may cancel the event by pressing the **ABORT EVENT** soft key.

When all data for an event has been entered, the entire event will be shifted to the left side of the screen and the conversation line will ask you to select the next event.

7.3.1 Assumed Tool Offset, Feedrate, and Tool

The ProtoTRAK LX3 will automatically program the following:

TOOL OFFSET: for a Turn or Arc Event, same as the last event if that event was a Turn or Arc event

FEED PER MIN/FEED PER REV: same as last event if that event was a Turn, Arc, or Cycle

RPM/SURFACE SPEED: same as last event

TOOL #: same as last event

You may change these assumed inputs by simply inputting the correct data when the event is programmed.

7.3.2 Programming Spindle Speeds and Feedrates

If you are not completely familiar with working with constant surface speed (CSS) programming, please go back and review sections 5.10 and 5.11 to be sure you understand them. With this knowledge we suggest the following:

- a) If you program with CSS (by inputting SFM or SMM) the X absolute zero must be at the part or spindle centerline. Fortunately this is the only logical place anyway.
- b) When you program for CSS we recommend that you program feeds in inches per revolution (IPR) or millimeters per minute (MMPR). If you use IPM or MMPM and CSS you can end up with some unexpected cuts, especially if the workpiece has both small and large diameters.

- c) Check the machinery handbook or your insert supplier charts for recommended SFM or SMM speeds. These recommendations are often broad so experiment cautiously.
- d) CSS and IPR or MMPR programming will provide the best part finish.

7.4 POSITION Events

This event type positions the tool to the programmed position. The positioning is always at rapid speed (modified by feedrate override) and in the most direct path possible from the previous location.

Position is most often used to move the tool away from the part so that when it rapids to a next non-connective event or home, it will not crash into the workpiece.

To program a Position event press the **POSN** soft key on the Select Event screen (see Section 7.1). The following screen will appear:

PROG P/N 12345				INCH				> STATUS
				EVENT ___ POSITION				> INFORMATION
				X				
				Z				> CONVERSATION
				RPM/SURFACE SPEED				
				CONTINUE				> SOFT KEYS
				TOOL #				
X								
		DATA FWD	DATA BACK				ABORT EVENT	

Where:

X: is the X dimension (diameter)

Z: is the Z dimension

RPM/SURFACE SPEED: is the spindle speed. Enter data and press INC SET for RPM or ABS SET for SFM or SMM

CONTINUE: asks you if you wish to continue on to the next event (press 1, SET), or pause after the tool is at position (press 0, SET)

TOOL#: is the tool number you assign from 1-50

7.5 DRILL Events

This event allows you to drill a hole at the centerline of the part (X = 0 ABS) using the carriage and cross-slide. In many instances it may be more convenient to program a Position event with a No continue, and drill with the tail stock.

The event tool motion will be to rapid in a straight line to X = 0 ABS and the programmed Z RAPID position, then feed to Z FINAL, then rapid out to Z RAPID.

Press the **DRILL** soft key. The screen will show:

PROG P/N 12345				INCH		> STATUS
				EVENT ___ DRILL Z RAPID Z FINAL RPM/SURFACE SPEED FEED PER MIN/FEED PER REV # PECKS TOOL #		> INFORMATION
Z RAPID						> CONVERSATION
		DATA FWD	DATA BACK			ABORT EVENT >SOFT KEYS

Where:

Z RAPID: is the Z dimension to transition from rapid to feed

Z FINAL: is the Z depth of the hole

RPM/SURFACE SPEED: is the spindle speed. Enter data and press INC SET for RPM or ABS SET for SFM or SMM. If the drill is programmed using CSS the RPM will be calculated based on what drill diameter you enter to tool setup mode.

FEED PER MIN/FEED PER REV: is the Z drilling feedrate. Enter data (0.1 - 99.9 ipm/2.5 - 2500 mmpm) and press INC SET for inch per minute feed or enter data (0.001 - 0.099 ipr/0.025 - 2.5 mmpr) and press ABS SET for inch per revolution feed

PECKS: is the number of tool withdrawal cycles (each cycle drills progressively less)

TOOL#: is the tool number you assign from 1-50

7.6 BORE Events

This event allows you to bore a part using a standard boring bar.

The event tool motion will be to rapid in a straight line to the programmed X dimension, the programmed Z RAPID position, then feed to Z FINAL, then feed .01 inch towards the centerline in X to clear the tool from the part, then rapid out to Z RAPID.

Press the **BORE** soft key. The screen will show:

PROG P/N 12345		INCH		> STATUS
		EVENT___ BORE X Z RAPID Z FINAL RPM/SURFACE SPEED FEED PER MIN/FEED PER REV TOOL #		> INFORMATION
X				> CONVERSATION
		DATA FWD	DATA BACK	ABORT EVENT >SOFT KEYS

Where:

X: is the diameter of the bore

Z RAPID: is the Z dimension to transition from rapid to feed

Z FINAL: is the Z depth of the bore

RPM/SURFACE SPEED: is the spindle speed. Enter data and press INC SET for RPM or ABS SET for SFM or SMM

FEED PER MIN/FEED PER REV: is the Z boring feedrate. Enter data (0.1 - 99.9 IPM/2.5 - 2500 MMPPM) and press INC SET for inch per minute feed or enter data (0.001 - 0.099 IPR/0.025 - 2.5 MMPPR) and press ABS SET for inch per revolution feed

TOOL#: is the tool number you assign from 1-50

7.7 TURN Events

This event allows you to turn in a straight line from any one XZ point to another, including an inside or outside taper. This event should be used for facing since this is also a straight line move from one XZ point to another. The event may be programmed with a CHAMFER or CONRAD if it is connective with the next event.

The event tool motion will be to rapid to the X BEGIN, Z BEGIN position, then feed to X END, Z END with consideration for CHAMFER or CONRAD if one is programmed.

Press the **TURN** soft key. The screen will show:

PROG P/N 12345				INCH				> STATUS
				EVENT___ TURN X BEGIN Z BEGIN X END Z END CHAMFER TOOL OFFSET RPM/SURFACE SPEED FEED PER MIN/FEED PER REV TOOL #				> INFORMATION
X BEGIN								> CONVERSATION
		DATA FWD	DATA BACK				ABORT EVENT	>SOFT KEYS

Where:

X BEGIN: is the X dimension to the beginning of the cut (diameter)

Z BEGIN: is the Z dimension to the beginning of the cut

X END: is the X dimension to the end of the cut; incremental is from X Begin

Z END: is the Z dimension to the end of the cut; incremental is from Z Begin

CHAMFER/CONRAD: is the dimension of a chamfer or tangential radius to the next event. Use ABS SET for chamfer, or INC SET for conrad.

TOOL OFFSET: is the selection of the tool offset to right (input 1), offset to left (input 2), or tool center--no offset (input 0) relative to the programmed edge and direction of tool cutter movement (see Section 5.5)

RPM/SURFACE SPEED: is the spindle speed. Enter data and press INC SET for RPM or ABS SET for SFM or SMM

FEED PER MIN/FEED PER REV: is the turning feedrate. Enter data (0.1 - 99.9 IPM/2.5 - 2500 MPPM) and press INC SET for inch per minute feed or enter data (0.001 - 0.099 IPR/0.025 - 2.5 MMPR) and press ABS SET for inch per revolution feed

TOOL #: is the tool number you assign from 1-50

7.8 ARC Events

This event allows you to turn with circular contouring any arc (fraction of a circle).

The event tool motion will be to rapid to the X Begin, Z Begin position, then feed to X End, Z End in a circular path.

Press the **ARC** soft key. The screen will show:

PROG P/N 12345				INCH				> STATUS
				EVENT _ _ _ _ ARC				
				X BEGIN				
				Z BEGIN				
				X END				
				Z END				
				RADIUS				> INFORMATION
				CHAMFER				
				DIRECTION				
				TOOL OFFSET				
				RPM/SURFACE SPEED				
				FEED PER MIN/FEED PER REV				
				TOOL #				
X BEGIN								> CONVERSATION
		DATA	DATA				ABORT	
		FWD	BACK				EVENT	> SOFT KEYS

Where:

X BEGIN: is the X dimension to the beginning of the arc cut (diameter)

Z BEGIN: is the Z dimension to the beginning of the arc cut

X END: is the X dimension to the end of the arc cut; incremental is from X Begin

Z END: is the Z dimension to the end of the arc cut; incremental is from Z Begin

RADIUS: is the radius of the arc (not measured in diameter)

CHAMFER/CONRAD: is the dimension of a chamfer or tangential radius to the next event. Use ABS SET for a chamfer, or INC SET for conrad.

DIRECTION: is the clockwise (input 1), or counterclockwise (input 2) direction of the arc looking down from the top

TOOL OFFSET: is the selection of the tool offset to right (input 1), offset to left (input 2), or tool center--no offset (input 0) relative to the programmed edge and direction of tool cutter movement (see Section 5.5)

RPM/SURFACE SPEED: is the spindle speed. Enter data and press INC SET for RPM or ABS SET for SFM or SMM

FEED PER MIN/FEED PER REV: is the turning feedrate. Enter data (0.1 - 99.9 IPM/2.5 - 2500 MPM) and press INC SET for inch per minute feed or enter data (0.001 - 0.099 IPR/0.025 - 2.5 MPR) and press ABS SET for inch per revolution feed

TOOL #: is the tool number you assign from 1-50

7.9 Cycle Events (I.D. and O.D)

The Cycle Event is not a single event, but rather a group of events. It allows you to program complex shapes (including the shape of the starting material) that require several roughing passes without the need to program each tool motion step.

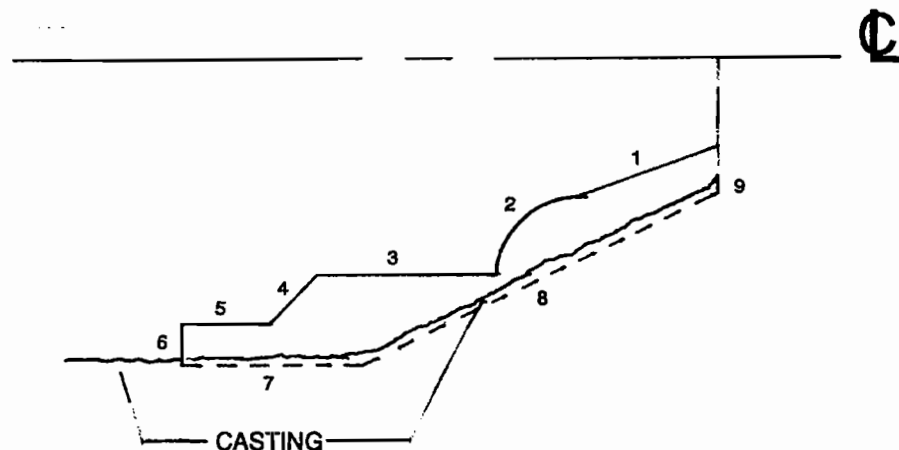

Consider the part above that is being machined from a rough casting. Lines 1-6 represent the finished part, and lines 7-9 represent the casting, or something a little bigger than the casting.

In creating a cycle event you must select whether you are basically O.D., or I.D. machining.

The rules for creating an Outside, or O.D. cycle are:

- a. The line segments representing the part (1-6 in the above figure) must be programmed with TURN or ARC events only.
- b. The line segments representing the original material (or just outside it) must be programmed with Position events. These are lines 7-9 above, and are programmed by entering the end point of each line.
- c. The first line segment must be one representing the part ("a" above) not the original material ("b" above).
- d. The X End and Z End of the last segment must be the same as the X Begin and Z Begin of the first. In the example above, line segment 9 must end where line segment 1 begins.
- e. There may be no more than 20 line segments for any Cycle.
- f. The roughing and finishing tools for the Outside Cycle events must be right-hand turning tools (see Type 1 in Section 9).
- g. The lines which represent the part (1-6 in the above figure) can never move toward the centerline (decreasing X), or away from the chuck (increasing Z). Moves with no change in X or Z are okay.
- h. The lines which represent the original material or something a little bigger (lines 7-9 in the above figure) can never move away from the centerline (increasing X), or toward the chuck (decreasing Z). Moves with no change in X or Z are okay.

The rules for creating an Inside, or I.D. cycle are:

- a.-e. Same as above for Outside cycles.
- f. The roughing and finishing tools for the Inside Cycle events must be boring tools (see Type 3 in Section 9).
- g. The lines which represent the finished part can never move away from the centerline (increasing X), or away from the chuck (increasing Z). Moves with no change in X or Z are okay.

- h. The lines which represent the original material or something a little bigger can never move toward the centerline (decreasing X), or toward the chuck (decreasing Z). Moves with no change in X or Z are okay.

The event tool motion depends on whether you select to rough the material with successive turning passes (Z motion with constant X), or facing passes (X motion with constant Z). If you choose turning, the tool will rapid to a point at the programmed material—a point along line 8 in the figure above. Then the tool will feed at a constant X position across until it nears one of the part lines leaving enough material for the programmed finish cut. This is repeated until the part is completely roughed. Then the tool will feed along the part lines standing off an amount equal to the finish cut. Then the carriage will move to home and call out the finish tool. This tool will rapid to the beginning of the first line and turn the part to its final dimension.

Press the **CYCLE** soft key. The screen will show:

PROG P/N 12345		INCH		> STATUS
		EVENT ___ CYCLE		
		SIDE		
		# OF PASSES		
		APPROACH		
		RPM/SURFACE SPEED		> INFORMATION
		FEED PER MIN/FEED PER REV		
		TOOL #		
		FIN CUT		
		FIN RPM/SURFACE SPEED		
		FIN FEED PER MIN/FEED PER REV		
		FIN TOOL #		
0=inside, 1=outside:				> CONVERSATION
		DATA FWD	DATA BACK	
				ABORT EVENT
				>SOFT KEYS

The purpose of this screen is to define the overall parameters of the cycle event through the following prompts:

SIDE: is to select an inside (input 0, SET), or outside (input 1, SET) cycle

OF PASSES: is the number of equal depth cuts used to rough the part

APPROACH: is to select if the roughing is to be done along X with facing passes (input 0, SET), or along Z with turning passes (input 1, SET)

RPM/SURFACE SPEED: is the spindle speed. Enter data and press INC SET for RPM or ABS SET for SFM or SMM

FEED PER MIN/FEED PER REV: is the roughing feedrate. Enter data (0.1 - 99.9 IPM/2.5 - 2500 MPPM) and press INC SET for inch per minute feed or enter data (0.001 - 0.099 IPR/0.025 - 2.5 MPPR) and press ABS SET for inch per revolution feed

TOOL #: is the number you assign to the roughing tool

FIN CUT: is the depth of the final finish cut made with the finish tool

FIN RPM/SURFACE SPEED: is the spindle speed. Enter data and press INC SET for RPM or ABS SET for SFM or SMM

FIN FEED PER MIN/FEED PER REV: is the finish feedrate. Enter data (0.1 - 99.9 IPM/2.5 - 2500 MPPM) and press INC SET for inch per minute feed or enter data (0.001 - 0.099 IPR/0.025 - 2.5 MPPR) and press ABS SET for inch per revolution feed

FIN TOOL #: is the number you assign to the finishing tool

When the screen is complete, the ProtoTRAK LX3 will prompt you to input a series of TURN, ARC and POSITION events to describe the part and the original material.

The first screen will have the soft keys:

SELECT							
	TURN	ARC					ABORT EVENT

Select the appropriate event type to define your first line segment on your part and program it as you would any other TURN or ARC event.

When the first line is defined, the screen will show the following soft keys:

SELECT							
POSN	TURN	ARC CW	ARC CCW		END CYCLE		

Where you should continue to define the part with TURN, ARC CW or ARC CCW events followed by defining the original material with POSITION events. When the last POSITION event is defined (remember it must end where the first event began), press the **END CYCLE** key when the display prompts the above.

7.10 Thread Event

This event allows you to machine standard or custom I.D. or O.D. threads. They may be straight or tapered, and may be one through ten multiple leads.

The event tool motion will be to rapid to the X Begin, Z Begin position, then feed to a depth equal to the total thread depth adjusted for the number of passes, then feed to X End, Z End, then rapid away from the thread, then return to X Begin, Z Begin and repeat for the total number of passes.

The spindle speed for a thread can be programmed in either RPM or CSS. It should be noted that the spindle speed will not increase for each pass if the thread is programmed in CSS. The initial speed calculated will be used for each pass in the thread.

Note: To activate a custom threading cycle use Service Code 144. Code 144 will toggle back and forth between standard and custom threads.

7.10.1 Standard Thread Event

The LX3 will automatically calculate the depth of a standard thread.

Press the Thread soft key. The screen will show:

PROG P/N 12345				INCH				> STATUS
				EVENT _ _ _ _ THREAD X BEGIN Z BEGIN X END Z END PITCH # PASSES # SPRING PASSES PLUNGE ANGLE SIDE # OF STARTS RPM/SURFACE SPEED TOOL #				> INFORMATION
X BEGIN								> CONVERSATION
		DATA FWD	DATA BACK				ABORT EVENT	>SOFT KEYS

Where:

X BEGIN: is the X dimension or major diameter where the thread begins (diameter) *Note: ID threads are also programmed using the major diameter for X begin.*

Z BEGIN: is the Z dimension where the thread begins

X END: is the X dimension or major diameter when the thread will end. This should be 0, INC SET for a straight thread

Z END: is the Z dimension where the thread ends

PITCH: is the distance from one thread to the next in inches or mm. It is equal to one divided by the number of threads per inch. For example, the pitch for a 1/4-20 screw is 1 divided by 20 = .05 inches.

PASSES: is the number of passes (1-99) to cut the thread to its final depth (excludes spring passes)

SPRING PASSES: is the number of passes (0-99) at the final depth

PLUNGE ANGLE: is the angle the tool feeds into the beginning depth. The default 29.5 degrees is recommended

SIDE: selects whether this is an I.D. (input 0,SET), or O.D. (input 1,SET) thread

STARTS: selects whether the thread is single lead (input SET or 1,SET), double lead (input 2,SET), triple lead (input 3,SET), etc. (up to 10 leads)

RPM/SURFACE SPEED: is the spindle speed. Enter data and press INC SET for RPM or ABS SET for SFM or SMM

TOOL #: is the tool number you assign from 1-50

7.10.2 Custom Thread Event

This event allows you to machine a non-standard or custom thread such as an Acme or Butress thread.

Press the **THREAD** soft key. The screen will show:

PROG P/N 12345				INCH				> STATUS
				EVENT ___ CUSTOM THREAD X MAJOR BEGIN Z BEGIN X MINOR BEGIN X MAJOR END Z END PITCH # PASSES # SPRING PASSES PLUNGE ANGLE SIDE # OF STARTS RPM/SURFACE SPEED TOOL #				> INFORMATION
X BEGIN								> CONVERSATION
		DATA FWD	DATA BACK				ABORT EVENT	>SOFT KEYS

Where:

X MAJOR BEGIN: is the X dimension or major diameter where the thread begins (diameter)

Z BEGIN: is the Z dimension where the thread begins

X MINOR BEGIN: is the minor diameter of the thread. If you want to program a custom tapered thread the ending minor diameter will be calculated from the X major end information. In other words, the minor diameter will be parallel to the major diameter.

X MAJOR END: is the X dimension or major diameter when the thread will end. This should be 0, INC SET for a straight thread

Z END: is the Z dimension where the thread ends

PITCH: is the distance from one thread to the next in inches or mm. It is equal to one divided by the number of threads per inch. For example, the pitch for a 1/4-20 screw is 1 divided by 20 = .05 inches.

PASSES: is the number of passes (1-99) to cut the thread to its final depth (excludes spring passes)

SPRING PASSES: is the number of passes (0-99) at the final depth

PLUNGE ANGLE: is the angle the tool feeds into the beginning depth.

SIDE: selects whether this is an I.D. (input 0,SET), or O.D. (input 1,SET) thread

STARTS: selects whether the thread is single lead (input SET or 1,SET), double lead (input 2,SET), triple lead (input 3,SET), etc. (up to 10 leads)

RPM/SURFACE SPEED: is the spindle speed. Enter data and press INC SET for RPM or ABS SET for SFM or SMM

TOOL #: is the tool number you assign from 1-50

7.11 Repeat Events

The Repeat event allows you to repeat an event or a group of events up to 99 times with an offset in X and/or Z. This can be useful for a simple roughing cycle (and where a full CYCLE event is inappropriate) at increasing depths. It is also very useful in programming rough and finish events without having to worry about adjusting the dimensions for the finish cut (see Section 7.14).

Repeat events may be "nested" five deep. That is, you can repeat a repeat event, of a repeat event, of a repeat event of some programmed event(s). One new tool number may be assigned for each Repeat Event.

Press the **REPEAT** soft key. The display will show:

PROG P/N 12345				INCH				> STATUS
				EVENT ___ REPEAT				
				FIRST EVENT #				
				LAST EVENT #				
				X OFFSET				
				Z OFFSET				> INFORMATION
				# REPEATS				
				TOOL #				
FIRST EVENT #								> CONVERSATION
		DATA FWD	DATA BACK				ABORT EVENT	> SOFT KEYS

Where:

FIRST EVENT #: is the event number of the first event to be repeated

LAST EVENT #: is the event number of the last event to be repeated; if only one event is to be repeated, the Last Event # is the same as the First Event #

X OFFSET: is the incremental X offset from event to be repeated (diameter)

Z OFFSET: is the incremental Z offset from event to be repeated

REPEATS: is the number of times events are to be repeated up to 99

TOOL #: is the tool number you assign from 1-50

7.12 Aborting a Partially Programmed Event

If you wish to not program an event (or start over) after you have started to program, press the **ABORT EVENT** soft key. The screen will show the "Select Event" screen as described in Section 7.1. Re-select the event type or another.

7.13 Editing Data While Programming an Event

All data is entered by pressing the appropriate numeric keys and pressing **INC SET** or **ABS SET**. If you enter an incorrect number before you press **INC SET** or **ABS SET** you may clear the number by pressing **RSTR** (Restore). Then, input the correct number and press **SET**.

If incorrect data has been entered and **SET**, you may correct it as long as you are still programming that same event. Press the **DATA BACK** or **DATA FWD** (Forward) soft key until the incorrect prompt and data are highlighted and shown in the conversation line. Enter the correct number and **SET**. The ProtoTRAK LX3 will not allow you to skip past prompts (by pressing **DATA FWD**) that need to be entered to complete an event.

Previous events may be edited in the Edit Mode (see Section 8).

7.14 Finish Cuts

The Cycle event is designed with a built-in finish cut routine. You may, however, want to program a roughing cut and a finish cut on a part which has been defined by BORE, TURN, and ARC events.

The hard way to do this is to adjust all the X and Z dimensions (this is especially tricky for arcs) for the roughing cut, then program the correct part dimensions for the finish cut.

The easy way is to use the following technique:

- a. Program the actual part shape and ignore the need to leave material for a finish cut.
- b. Use one Repeat event to repeat all the events in "a" above, but call out a different tool number even if you are actually using the same tool.

- c. In Set-Up Mode input an XMOD and ZMOD for the tool in the events programmed in "a" above that is equal to the finish cut material you wish to leave. See Section 9 for how to input this data.
- d. In Set-Up Mode make **NO** special adjustment to XMOD or ZMOD for the tool programmed in the Repeat event in "b" above.

When the part is being run the XMOD and ZMOD from "c" will command the tool to stay away by this amount when the events from "a" are machined. However, when these events are repeated from "b", the correct dimensions will be cut on the part.

7.15 Sample Program

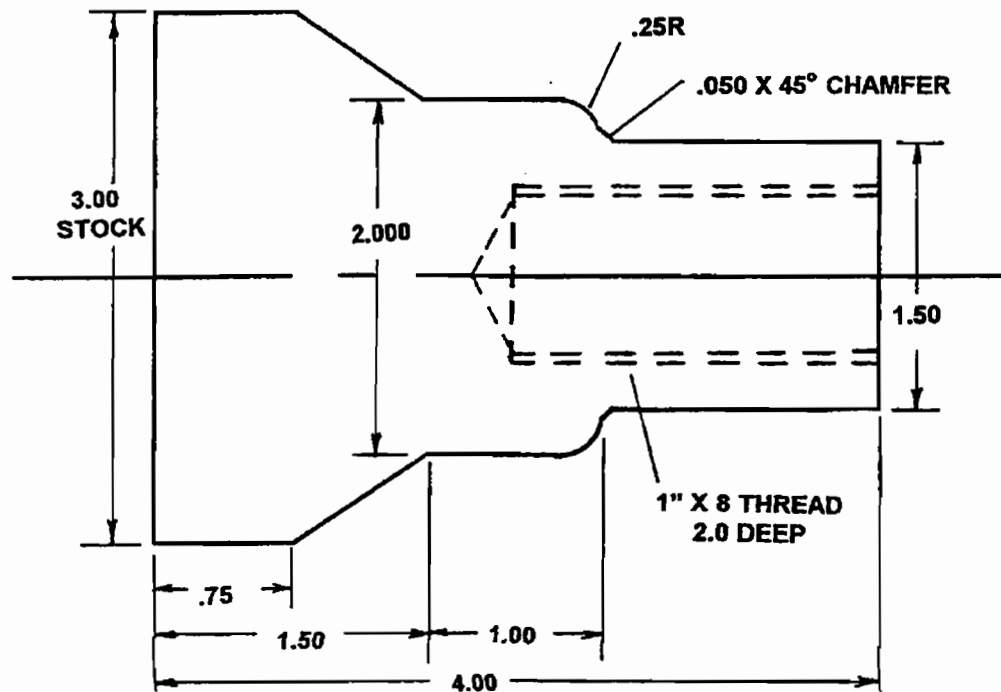

Step 1 - Decide how the part will be machined.

Saw a piece of material from 3 inch stock slightly longer than 4", and face the end which will be held in the step jaws of the chuck. The material used in this example is 1020 steel.

NOTE: The part below was programmed, as an example, using 2 different speed and feed values: CSS and in/rev and also RPM and in/min. The speed and feeds can be programmed using any combination. See section 7.3.2 for some more information on this topic.

Establish the program absolute zero as the centerline for X, and the left side of the part (against the chuck jaw step) for Z.

The program strategy will be:

- a. Use a Turn Event to face the part to length with a roughing Turn/Face Tool (see Section 9.2).
- b. Use a Cycle Event to rough (with the above tool) and finish (with a finishing Turn/Face tool) the outside shape.
- c. Use a Drill Event and a 13/16 drill to open the hole.
- d. Use a Bore Event and boring tool to size the hole.
- e. Use a Thread Event and thread insert to make the 1"-8 thread.

Step 2 - Erase any program that is in the current memory.

- a. Be sure you have stored the current program (see Section 12) if you wish to save it.
- b. Press **MODE**, select **EDIT**, press **ERASE PROG**, press **YES**.

Step 3 - Enter the Program Mode and input the part number.

Step 4 - Select TURN and input the following data to face the part for Event 1:

X Begin	3.1 abs
Z Begin	4.0 abs
X End	0 abs
Z End	0 inc (or 4.0 abs set)
Chamfer	set (a 0 is not required)
Tool Offset	1 for Right
RPM/Surface Speed	1000 INC SET or 400 ABS SET
Feed per minute/Feed per rev	5 INC SET or 0.005 ABS SET
Tool #	1

Step 5 - Create the program for the outside profile by inputting the following data:

- a. Press **CYCLE** to define the overall parameters and input for Event 2:

Side	1
# of Passes	10
Approach	1 for Z
RPM/Surface Speed	1000 INC SET or 400 ABS SET
Feed per minute/Feed per rev	5 INC SET or 0.005 ABS SET

Tool #	1
Fin Cut	.005
Fin RPM/Surface Speed	1000 INC SET or 400 ABS SET
Fin Feed per minute/Feed per rev	3.0 INC SET or 0.003 ABS SET
Fin Tool #	2

- b. Press **TURN** to define the 1.5 O.D. and chamfer to the next event and input for Event 3:

X End	0 inc
Z End	2.5 abs
Chamfer	.05 abs set

- c. Press **ARC CW** to define the .25 radius arc and input for Event 4:

X End	2.0 abs
Z End	-.25 inc
Radius	.25
Chamfer	abs set

- d. Press **TURN** to define the 2.0 O.D. and input for Event 5:

X End	0 inc
Z End	1.5 abs
Chamfer	abs set

- e. Press **TURN** to define the taper and input for Event 6:

X End	3.0 abs
Z End	.75 abs
Chamfer	abs set

- f. Press **POSN** (position) to define the O.D. of the original stock and input for Event 7:

X End	3.0 abs
Z End	4.0 abs

- g. Press **POSN** to define the right side end of the material and position you back to the X Begin and Z Begin where you started (b) and input for Event 8:

X End	1.5 abs
Z End	4.0 abs

- h. Press **END CYCLE** to declare the end of the cycle event group of events.

Step 6 - Select **DRILL** and input the following data to drill a 13/16 (.8125) hole for Event 9:

Z Rapid	4.1 abs
Z Final	1.7 abs (drill .3 farther to compensate for tip)
RPM/Surface Speed	425 INC SET or 100 ABS SET

Feed per minute/Feed per rev	2.0 INC SET or 0.005 ABS SET
# Pecks	5
Tool #	3

Step 7 - Select **BORE** to size hole to .875 (the minor diameter) and input for Event 10:

X	.875 abs
Z Rapid	4.1 abs
Z Final	1.95 abs (a little clearance for the thread insert)
RPM/Surface Speed	625 INC SET or 150 ABS SET
Z Feed per minute/Feed per rev	3 INC SET or 0.005 ABS SET
Tool #	4

Step 8 - Select **THREAD** to program the 1"-8 thread 2.0 inch deep and input for Event 11:

X Begin	1.0 abs (the major diameter)
Z Begin	4.1 abs
X End	0 inc (no taper)
Z End	2.0 abs
Pitch	.1
# of Passes	6
# of Spring Passes	2
Plunge Angle	29.5 (use recommended default)
Side	0 for inside
# of Starts	1 (this is a single lead thread)
RPM/Surface Speed	625 INC SET or 150 ABS SET
Tool #	5

Step 9 - Enter the Set-Up Mode (see Section 9) and select **SET HOME**.

Press **X, 4., ABS SET** and **Z, 6., ABS SET** to identify a point well off the part where the tool will go at Run start, tool change, and Run End.

Press **RETURN, MODE, DRO**.

Step 10 - Load the part into the chuck. In the DRO Mode and with a facing tool, take a skin cut on the face of the part so that you have a consistent and flat surface to touch-off your tools. Use a micrometer or vernier to measure the part diameter and length.

Press **MODE, SET UP, TOOL SET UP**.

Step 11 - Configure Tool # 1 (the roughing turn/face tool).

- a. Mount the tool into its holder and mount on the tool post.
- b. Press 1, **SET**.
- c. Press **SET NEW**.
- d. Press 1, **SET** because Tool #1 is a right-hand turn/face tool.
- e. Using the handwheels, move the tool so that it touches the side of the part as shown by the SET X line on the ProtoTRAK screen diagram.
- f. Input the part diameter (say 3.004), ABS SET.
- g. Move the tool so that it touches the face of the part as shown by the SET Z line on the screen.
- h. Input the length of the part (say 4.073), ABS SET or you may input 0, ABS SET.
- i. Input the tool tip radius and SET. If you are using inserts, this radius will be shown on the box.
- j. Ignore XMOD and ZMOD for now.
- k. Press **RETURN**.

Step 12 - Configure Tool #2 (the finish turn/face tool).

- a. Mount the tool as in Step 11.
- b. Press 2, **SET**.
- c. Press **SET NEW**.
- d. Press 1, **SET** because Tool #1 is a right-hand turn/face tool.
- e-k. Follow the directions in Step 11 being sure in (h) to touch off the same place and input the same dimension as you used before.

Step 13 - Configure Tool #3 (the 13/16 drill).

- a. Follow the same pattern as above, inputting Tool #3 and selecting Drill (5).
- b. For setting X, touch the side of the drill to the side of the part nearest you and input the 3.004 part diameter. For setting Z, touch the tip to the end of the part and set the same number you did for Steps 11 or 12.
- c. Input and SET the drill diameter when prompted.
- d. Press **RETURN**.

Step 14 - Configure Tool #4 (the boring bar).

- a. Follow the same pattern as above, inputting Tool #4 and selecting Bore (3).
- b. For setting X, touch the tool as shown to the side of the part away from you and input -3.004, ABS SET. Set Z and the Radius as above.
- c. Press **RETURN**.

Step 15 - Configure Tool #5 (the threading tool).

- a. Follow the same pattern as above, inputting Tool #5 and selecting Thread ID (8).
- b. For setting X, touch the tool as shown to the side of the part away from you (just as you did with the boring tool) and input -3.004, ABS SET. Set Z as above.
- c. Press **RETURN**.
- d. Press **RETURN** again.

Step 16 - Check your program by selecting DRAW PART and pressing START. It should look like this:

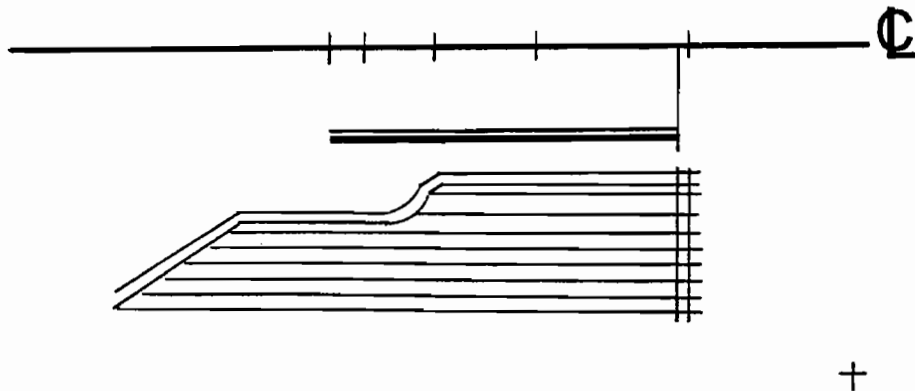

Step 17 - Run the part.

- a. Press **MODE** and select **DRO**.
- b. Load Tool #1 and press **TOOL #, 1, SET**.
- c. In the Z direction, touch Tool #1 to the bottom of the jaw step and set Z = 0 ABS SET.

- d. Load a part and measure its diameter.
- e. Touch Tool #1 to the side of the part and set X = 3.004 ABS SET (or the diameter you measured in [d] above).
- f. Press **MODE**, and select **RUN**.
- g. Press **START**. The carriage will rapid so that Tool #1 is at home (X=4., Z=6.).
- h. Start the spindle at an appropriate RPM. Note all feeds in the program assume an aluminum part. Adjust if necessary.
- i. Press **TRAKING**.
- j. Turn the Z handwheel counterclockwise and machine the first part.
- k. If you wish to run in pure CNC instead of TRAKING, press **STOP**, **CNC RUN, GO**.

Step 18 - Correcting the program to get a more accurate part.

It is difficult in Tool Set Up, Steps 11-15, to touch off the part with necessary precision. As a consequence, your part dimensions may not be exactly to print. To correct, or "tweak" a program:

- a. Run and then measure the first part.
- b. Enter Set Up Mode and Select **TOOL SET UP**.
- c. Enter the tool number that created the inaccurate cut. Select **EDIT**.
- d. Press **DATA FWD** to XMOD or ZMOD. Input the dimension equal to the part error. Remember a plus XMOD makes the diameter bigger, and a plus ZMOD makes the part longer.
- e. Re-run the part.
- f. If you can't risk ruining the first part, input a plus (for O.D.), or minus (for I.D.) .02 XMOD and ZMOD for every tool. Then run the part, measure your errors, adjust the XMOD and ZMOD, and re-run.

8.0 EDIT Mode

The ProtoTRAK LX3 allows for complete editing of programs including the recall (and correction) of data, adding events in the middle of a program, deleting events within the program, and erasing programs.

8.1 Enter Edit Mode

Press **MODE** and select the **EDIT** soft key. The display will show:

EDIT P/N 12345				INCH				> STATUS
								> INFORMATION
SELECT								> CONVERSATION
RECALL	ADD EVENT	DELETE EVENT	ERASE PROG					>SOFT KEYS

8.2 Recall and Data Correction

To recall the data in your current program select the **RECALL** soft key. The conversation line will prompt "EVENT #" asking for the event number you wish to review. Input the event number and **SET**. If you wish to change the part number, recall event 0. Assuming you requested Event 4, the display will show, for example:

PROG P/N 12345				INCH				> STATUS
EVENT 3 POSITION				EVENT 4 TURN				
X		3.42 abs		X BEGIN		2.4370 abs		
Z		7.5 abs		Z BEGIN		7.2950 abs		
SURFACE SPEED	400			X END		1.5000 inc		> INFORMATION
CONTINUE	YES			Z END		2.0000 inc		
TOOL #	2			CONRAD		NONE		
				TOOL OFFSET		RIGHT		
				SURFACE SPEED		400		
				FEED PER REV		0.005		
				TOOL #		2		
X BEGIN 2.4370 abs								> CONVERSATION
PAGE FWD	PAGE BACK	DATA FWD	DATA BACK				ABORT EVENT	>SOFT KEYS

Where:

- The event you recalled is shown with its data on the right side of the information area.
- The previous event is shown to the left.
- The conversation line shows the first prompt for the selected event.
- The **PAGE FWD** (Forward) soft key indexes the event forward by one (from 3 and 4, to 4 and 5 in the above example).
- The **PAGE BACK** soft key indexes the event back by one (from 3 and 4, to 2 and 3 in the above example).
- The **DATA FWD** (Forward) soft key steps the highlight and conversation line to the next prompt and data (Z Begin 7.2950A in the above example).
- The **DATA BACK** soft key steps the highlight and conversation line to the previous prompt.
- The **EVENT #** soft key allows you to input and recall another event without repeatedly paging.
- The **RETURN** soft key brings you back to the screen shown in Section 8.1.

To correct any data, use the **EVENT #**, **PAGE** and **DATA** soft keys to get the data you wish to correct into the conversation line. Re-input and **SET** the correct data.

Note: If the Feedrate is edited in any event it will automatically be edited in every subsequent and contiguous event with the same Tool number and feedrate. For example, let's say events 5 through 10, and 13 through 16 were all programmed with tool number 2, and 5 inches per minute feedrate. If you edit the feedrate in Event 7 to 3 inches per minute, it will automatically change Events 8, 9, and 10 also. Events 5, 6, 13, 14, 15, and 16 will not be affected.

If you request Event 0, the status line will prompt for a new program part number. It may be changed if you wish by inputting the new number and pressing **SET**.

8.3 Adding an Event

Events may be added to the program at the beginning, middle, or end of the program one at a time.

To do so, press the **ADD EVENT** soft key from the screen shown in Section 8.1. The conversation line will state "After Event #." Input the event number which the event you wish to add will follow and press **SET**. The screen will ask you to "Select Event," and program as you normally would (as described in Section 7).

When an event has been added, all subsequent events will be renumbered accordingly. Appropriate adjustments will automatically be made to Repeat events.

8.4 Deleting an Event

Events may be deleted one at a time or in continuous groups.

To do so, press the **DELETE EVENT** soft key from the screen shown in Section 8.1. The conversation line will state "Delete From #." Input the first event number of the group to be deleted, and press **SET**. The conversation line will then read "Delete to #" asking you to input the last event number of the group to be deleted, and press **SET**. If only one event is to be deleted, input its event number for both "Delete From #" and "Delete To #."

When an event or group of events have been deleted, all subsequent events will be renumbered to eliminate any number gaps. All event numbers in any Repeat event will also be renumbered.

8.5 Erasing a Program

You may erase your current program by pressing the **ERASE PROG** soft key shown in the screen in Section 8.1. However, if you ever wish to reuse this program, you must be certain that it has been saved on the ProtoTRAK LX3 floppy disk memory, or saved offline (see Section 12).

When you press the **ERASE PROG** soft key, the conversation line will

be highlighted and state "ARE YOU SURE YOU WISH TO ERASE THIS PROGRAM?". If you are, press the **YES** soft key. If you are not, press the **NO** soft key. The display will return to the Select Mode screen.

9.0 SET-UP Mode

The Set-Up Mode is used to input tool data, set a home position, and visually check out a program.

9.1 Enter Set-Up Mode

Press **MODE** and select the **SET-UP** soft key. The display will show:

SET-UP P/N 12345						INCH		> STATUS
								> INFORMATION
SELECT								> CONVERSATION
TOOL SET-UP	SET HOME	DRAW PART	TOOL PATH	MAX RPM	SERV CODES	SAVE TOOLS	TOOL GROUPS	> SOFT KEYS

9.2 Tool Set-Up

Please refer to Section 5.4 Tool Tip Radius Compensation, 5.9 Absolute, Tool, and Program References and 6.11 Tool Number. It is important that you fully understand the concepts in these sections before you Set-Up your tools.

The purpose of Tool Set-Up is to define each tool's type, offset from the other tools, tip radius, and modifiers. The MOD's, or modifiers, are simply small adjustments to the offsets which can be used to adjust for offset errors, tool wear, part deflection, or finish cuts (see Section 7.14)

Press the **TOOL SETUP** soft key. The screen will show:

SET-UP						INCH	> STATUS
							> INFORMATION
INPUT TOOL #							> CONVERSATION
						RETURN	> SOFT KEYS

Input the tool number and SET. Then, on the next screen, select **SET NEW** if you wish to describe a complete new tool, or **EDIT** if you wish to simply edit an existing description. If you select **SET NEW**, the display will show:

SET-UP						INCH	> STATUS	
1. RH TURN/FACE 2. LH TURN/FACE 3. BORE 4. BACK BORE 5. DRILL 6. GROOVE/CUTOFF 7. THREAD OD 8. THREAD ID			TOOL # _ _ _ _					> INFORMATION
SELECT							> CONVERSATION	
						RETURN	> SOFT KEYS	

Input the tool type 1 through 8 and SET. If, for example, you chose 1 (the right-hand turn or face tool) the display would show:

SET-UP P/N 12345		500 RPM		INCH		> STATUS		
		TOOL #		RH TURN/FACE				
		X		Z				
		R		X MOD		> INFORMATION		
		Z MOD		X=1.2345		Z -6.7890		
MOVE to known X value, INPUT and SET								> CONVERSATION
		DATA FWD	DATA BACK				RETURN	>SOFT KEYS

Where:

X: will prompt "move to known X value, input and SET" which means, touch the tool to some known reference at SET X in the picture on the left side of the screen, then input this reference X dimension and SET

Z: will prompt "Move to known Z value, input and set" which means, touch the tool to some known reference at SET Z in the picture on the left side of the screen, then input this reference Z dimension and SET

R: is to define the tool nose radius

X MOD: is to input an adjustment or modifier to the X offset. A positive X MOD will make the part O.D. or I.D. diameter larger by this amount

Z MOD: is to input an adjustment or modifier to the Z offset. A positive Z MOD will shift the part away from the chuck

Repeat the above procedure for all of the tools.

Note: The RPM value will be shown in the status line. To change the value it must be done in DRO mode.

CAUTION

The objective of Tool Set-Up is to establish the position of each tool relative to the others. To do this, the procedure must be conducted with one common counting or absolute reference. That is, between setting one tool and the next it is crucial that you do not go back into the DRO mode and change the absolute reference. If this happens, see Section 9.4

9.3 A Practical Technique for Accurate Tool Setting

The problem with setting tools as described in Section 9.2 above is that it is generally not possible to touch a tool off with high precision. Furthermore, under real cutting conditions the tool, part and machine deflect a little so that what you move and what you cut are not exactly the same.

If the parts you are machining require a high level of accuracy you should do the following:

- a. Set the tools as described in Section 9.2.
- b. Machine a test part that is as similar to your part as possible--same material, shape, etc.
- c. Measure the test part carefully noting which tool cut which dimension.
- d. Input X and Z modifiers which will maximize the parts accuracy.

9.4 Tool Set-Up When Adding or Changing Tools

For tool setting, it is absolutely necessary for every tool to be set with the same absolute reference. Therefore, if you add a new tool, or reset an existing one, you must be certain that your absolute reference is correct for the existing tools. Follow this procedure:

- a. Load one of the existing tools.
- b. Enter DRO Mode and call out the above Tool #.
- c. Touch off the side of a known diameter and X preset it in absolute.
- d. Touch off the end of a part or the chuck and Z preset it in absolute.
- e. Load the new tool.
- f. Set the new tool as you would in Section 9.2 measuring X diameter as you normally would, and measuring Z from the same position as "d" above.

9.5 Setting Home Position

Home is the location the tool will move to at the beginning of the run, for each tool change, and at the end of the run. This dimension is measured from the part program absolute zero.

Note: Home is defined as the position of the tool tip, not the position of the carriage and cross-slide. Make sure there is sufficient carriage and cross-slide travel for the tip of every tool to reach the Home location.

To set Home, press the **SET HOME** soft key from the screen in Section 9.1. The current X and Z Home locations will be displayed in the conversation line. To change them, press X or Z, the new value, and SET.

NOTE: a home position must be set before a program can be run.

9.6 Draw Part Graphics

The ProtoTRAK LX3 allows you to draw the part represented by your current program. To do so, press the **DRAW PART** soft key from the screen shown in Section 9.1. The display will show:

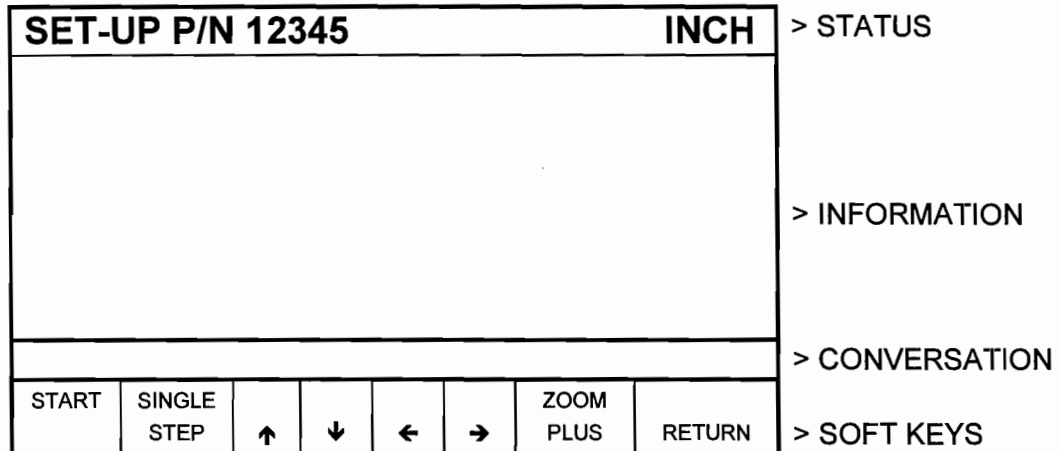

Where:

START: will draw the entire part scaled to fit within the screen drawing area. There may be a few seconds delay while the ProtoTRAK computes the proper scale.

SINGLE STEP: will draw one step at a time scaled to fit within the screen drawing area. The display line will show the event #.

↑ : will shift the drawing up by 10% for each press.

↓ : will shift the drawing down by 10% for each press

→ : will shift the drawing to the right by 10% for each press

← : will shift the drawing to the left by 10% for each press

ZOOM PLUS: will expand the size of the drawing by 10% for each press. Press the +/- key, and then the **ZOOM MINUS** key to shrink the drawing.

Press and hold the **START** soft key for 3 seconds to set the scale and shift back to the center of the screen.

RETURN: brings the display back to the Set-Up Select screen in Section 9.1

9.7 Tool Path Graphics

The ProtoTRAK LX3 allows you to graphically show the tool path associated with your current program. All movements at a programmed feedrate are shown as a solid line. All rapid position paths are shown as broken lines.

To show the tool path, press the **TOOL PATH** soft key from the screen shown in Section 9.1. The display will show the identical screen as the Draw Part Graphics screen (see Section 9.6). The soft keys also operate the same as for Draw Part Graphics.

Tool path graphics also checks the validity of your program, so always draw a part once before you run a new program.

9.8 Limiting Spindle Speed - MAX RPM

The ProtoTRAK allows you to limit the maximum spindle speed. When a maximum spindle speed is set it will limit the RPM of the spindle to this value no matter what speed is programmed. If a speed is programmed higher than the maximum limit, the maximum RPM limit programmed will flash in the status line.

When programming the maximum RPM limit you have the choice of entering the number desired and pressing **SET**, or teaching the speed desired. The following describes how to TEACH the maximum RPM.

- To TEACH the maximum RPM, press the **MAX RPM** soft key in SETUP mode and turn on the spindle. The spindle RPM will default to the lowest RPM in that gear.
- To set the maximum RPM press the **SPEED UP** or **SPEED DOWN** key. The RPM will increase with each press. Once you reach the desired RPM, press **INC SET**. This value will be stored until the next time you press **INC SET** in maximum RPM mode. The factory default for MAX RPM is set at 1000 RPM.

WARNING!

Set a maximum RPM that will not exceed maximum RPM of chuck.

9.9 Saving Tool Data

Tool types, offsets, radii, and modifiers are not saved with the program (see Section 12 for Program In/Out). To save this data, press the **SAVE TOOLS** softkey from the screen in Section 9.1.

WARNING!

If you turn the ProtoTRAK LX3 off (or if you lose power) and you have not saved your tools, all of your tool data will be lost! It is a good habit to do a simple SAVE TOOLS after you have made any tool additions or changes.

WARNING!

For any one tool number, only one set of tool data may exist at any time. When you do a SAVE TOOLS, the data for each tool number will be updated and the previous data (if different) will be lost.

9.10 Tool Groups

The Tool Groups soft key gives you the option of running programs using a single setup or a gang tooling setup. You can switch back and forth between either one of

either one of these setups at any time. The software will default to this single tool mode every time the control is turned on, a new program is written or a program is retrieved from the floppy disk.

Note: Before running any program, always draw the tool path to verify the tool is following the path you want.

9.10.1 Single Tool Setup

When using a single tool setup, the carriage will return to the programmed home position for each tool change. Once the tool reaches this position the spindle will turn off and the control will prompt you to load the next tool. Turn the spindle on and press GO to continue the program. If you are using the coolant pump in AUTO mode the coolant pump will come back on automatically once you press the go button or go into TRAKing mode. Please refer to Section 9.2 for procedures on how to setup up tools.

9.10.2 Gang Tool Setup

If you choose a gang tooling setup, all tools mounted on the cross-slide and called out in the program will carry out their operations without shutting down the spindle or turning off the coolant. The gang tooling feature allows you to mount as many tools as you can across the cross-slide. This machine lends itself well to this type of setup because of its long X-axis travel. Once the tools are bolted down to the cross-slide the tool setup procedures will be the same as the single tool setup (see Section 9.2). You will need to make sure the tools are positioned such that there is enough travel for the tools to complete their programmed path without exceeding the travel limits of the X-axis. A home position will only need to be set in the Z direction. After each tool completes its machining, the tool will retract only in the Z direction back to the set home position. From here, the next tool will follow a direct path to its starting point. It will be important to add the necessary position moves to make sure the next tool does not take a direct line into the material and cause a crash. This could very well be the case if you are using a tool that is mounted on the back side of the piece but is programmed to machine on the front side of the piece. Before running the program, draw the tool path in setup mode to verify the tools are following the correct path. At the end of your program the spindle will turn off and prompt you to start the next part. The only time the spindle will shut down and prompt you to press GO during a program is when you enter continue NO in a position event. This will be useful if you need to flip the part around in the chuck jaws in the middle of a program. The TRAKing feature works the same way in gang tooling mode.

The following message will be displayed in the conversation line when you are in gang tooling mode: PRESS GO FOR GANG TOOL RUN. It is very important to understand what TOOL GROUP mode you are in before running a program. If you are unsure go back into TOOL GROUP and select the mode you want to use. Failure to recognize which mode you are in may cause a crash. A good example of this would be if you think you are in single tool mode but you actually

are in gang tooling mode. Gang tooling mode will change tools automatically without prompting you to load the next tool or press GO.

The gang tooling kit consists of 6 tooling blocks, one (1) side tool holder and six (6) riser blocks. The six tool blocks will include: (2) facing tool blocks - single, (1) facing tool block double and (3) boring bar holders.

9.10.3 Indexer Setup

Use the Indexer setup if you are running a part program that uses the Dorian® Smartdex CNC Indexer. If you choose the indexer option in the Tool Group menu, the ProtoTRAK LX3 will index to the proper tool when it is called out in the program. It will carry out the machining operation without shutting down the spindle or turning off the coolant as it indexes from one tool to the next. To enter the Indexer Mode, choose INDEXER in the TOOL GROUPS menu located in SETUP Mode.

Note: If this option does not appear in the TOOL GROUPS menu, choose the SERV CODE option also located in SETUP mode and enter Service Code 145. To disable the index feature in the TOOL GROUPS menu, enter Service Code 146.

The Dorian® Smartdex CNC Indexer is an eight station, electro-pneumatic style indexer that uses an electrical stepper motor to index the different tools, and an air cylinder to lock and unlock the spline. You can set up to eight standard 3/4" tools in the indexer. Two boring bar holders that can hold a maximum boring bar diameter of 1.25" are supplied with the indexer. The indexer has a position and repeatability accuracy of +/- .0006° and .0017° with respect to the centerline of the lathe, respectively.

Once the tools are set in the indexer, setup procedures will be basically the same as the single tool setup (see Section 9.2) with the following exception: When you initially enter Tool Setup and input the tool number you want to set, the display will read "Move to Clearance and Press GO to Continue." Move the carriage to where no other tool will crash into the workpiece. Once you are clear of the workpiece, press GO to index the new tool to position. At this point you can either edit the tool or set up a new tool.

Note: You can input Tool 1-50 even though there are only eight tool stations. Tool #9 corresponds with Tool Station #1; Tool #10 corresponds with Tool Station #2, and so on. You may want to set up a Tool #9 if you want to add a modifier to your Tool #1 that was previously set up.

Before running the program, draw the tool path in setup mode to verify the tools are following the correct path. Also check to ensure you tools are arranged in the tool stations so that they do not crash into the chuck/collet during the program run.

Note: If at any time you are unsure if a tool is aligned properly, run Service Code 147 to home its true position. This may be necessary after you have hit the emergency stop button, or power was disconnected to the indexer while a tool was being indexed.

The following message will be displayed in the conversation line when you are ready to run a program to indexer mode: **PRESS GO FOR INDEXER RUN**. It is very important to understand what **TOOL GROUP** mode you are in before running a program. If you are unsure, go back into **TOOL GROUP** and select the mode you want to use. Failure to recognize which mode you are in may cause a crash. A good example of this would be if you think you are in single tool mode but you are actually in indexer mode.

Once you begin the program run, the indexer will index the shortest route to the appropriate tool without prompting for a tool change. The only time the spindle will shut down and prompt you to press **GO** during a program is when you enter **continue NO** in a position event. This will be useful if you need to flip the part around in the chuck jaws in the middle of a program. At the end of your program the spindle will turn off and prompt you to start the next part. The **TRAKing** feature works the same way in the indexer mode.

Note: During the program run, coolant will be supplied directly to the tip of the tool through a coolant line that is directly connected to the indexer. The nozzle that supplies the coolant to the tip of the tool can be easily adjusted by inserting a small Allen wrench or set screw into the nozzle to redirect the flow of the coolant as needed.

For service, maintenance and troubleshooting information please refer to the **TRAK TRL 1840 CSS Safety, Installation, Maintenance, Service and Parts Manual**.

9.11 Service Codes

These are special codes that may be entered into the ProtoTRAK LX3 to call up routines used in installation checkout and service.

9.11.1 Metric Default: Code 66

If you wish to have the ProtoTRAK LX3 power up in the metric measurement mode use the following procedure:

- a. Press the **SERV CODES** soft key from the screen in Section 9.1.
- b. Press **66 SET** when the conversation line prompts "CODE".

9.11.2 English Default: Code 67

If you wish to have the ProtoTRAK LX3 power up in the English measurement mode use the following procedure:

- a. Press the **SERV CODES** soft key from the screen in Section 9.1.
- b. Press **67 SET** when the conversation line prompts "CODE".

9.11.3 Preset All Defaults: Code 126

If you wish to have all service defaults reset to those standardized at the factory use the following procedure:

- a. Press the **SERV CODES** soft key from the screen in Section 9.1.
- b. Press 126 SET when the conversation line prompts "CODE".

9.11.4 Software ID: Code 33

If you wish to check the revision of the software in your ProtoTRAK LX3 use the following procedure:

- a. Press the SERV CODES soft key from the screen in Section 9.1.
- b. Press 33 SET when the conversation line prompts "CODE". The software identification will be shown in the Information area of the screen.

9.11.5 Adjust Following Error: Code 129

When the ProtoTRAK LX3 operates at high feedrates it may create small part machining errors as it goes around sharp corners. This exists on all CNC's and is commonly called a "following error." The ProtoTRAK LX3 is factory preset to allow a maximum following error of 0.005 inch. So that the limit is not violated, the feedrate will automatically be adjusted around sharp corners.

You may adjust the maximum following error to a value as small as .0001 inch. However, the smaller the value, the slower the feedrate around corners.

To input a few Following Error use the following procedure:

- a. Press the SERV CODES soft key from the screen in set-up mode.
- b. Press 129 SET when the conversation line prompts "CODE".
- c. Follow the instructions on the screen and input the Following Error value (from .0001 to .0100) and press INC SET.

9.11.6 Initialize Entire Tool Table: Code 139

If you wish to erase the entire tool table including offsets, radii and modifiers, use the following procedure:

- a. Press the SERV CODES soft key from the screen in Section 9.1.
- b. Press 139 SET when the conversation line prompts "CODE." The tool table will automatically be completely erased and lost.

9.11.7 Custom Threading Event: Code 144

If you wish to activate a custom threading cycle use the following procedure:

- a. Press the SERV CODES soft key in SETUP mode.
- b. Press 144 SET when the conversation line prompts "CODE." The custom thread event will replace the standard thread event.
- c. Entering Code 144 again will return the thread event back to standard.

10.0 PROGRAM RUN Mode

In the Run Mode the ProtoTRAK LX3 drives the carriage, cross-slide and spindle speed, and provides you with all the instructions necessary to successfully run the part.

10.1 Enter Run Mode

Press **MODE** and select the **RUN** soft key. The display will show:

RUN P/N 12	RPM	COURSE INCH	> STATUS
			> INFORMATION
SELECT			> CONVERSATION
START	START EVENT #		> SOFT KEYS

10.2 Starting to Run

Before running a part, you need to establish the position relationship between the part and tool. That is, you need to be certain that when the readout displays X=0 ABS and Z=0 ABS for any input tool, then that tool is at the program absolute zero of the part. To do this:

- a. Enter the DRO Mode.
- b. Load a tool and call up its Tool #.
- c. Load a part.

- d. Move to a known position on the part.
- e. ABS SET this position.
- f. Enter Run Mode and begin Run by pressing the **START** soft key.

If you wish to start in the middle of a program, press the **START EVENT #** soft key, input the number of the first event you wish to run, and **SET**.

10.3 Program Run

When you have started, the carriage and the cross-slide will move to home and the display will show the following if you are in single tool setup:

RUN	P/N 12	RPM	INCH	> STATUS
EVENT 1 TURN				
X 0.0000 ABS				
Z 0.0000 ABS				> INFORMATION
FEEDRATE = 0.0		OVERRIDE = 100%		
LOAD TOOL 1				> CONVERSATION
TRAKING		SHOW ABS	SHOW INC	> SOFT KEYS
		SHOW PATH	SHOW PROG	

If you are in gang tool setup the conversation line will display the following (see Section 9.10.2):

PRESS GO FOR GANG TOOL RUN				> CONVERSATION
TRAKING		SHOW ABS	SHOW INC	> SOFT KEYS
		SHOW PATH	SHOW PROG	

Where:

- The part number being run is shown in the status line.
- The programmed RPM is shown in the status line. This speed may be adjusted with the **SPEED ↑** and **SPEED ↓** keys.
- The event number and type being run is shown at the top of the information area.
- The current X, Z absolute positions are shown in the information area.
- The actual tool Feedrate is shown at the bottom of the information area.
- The current Feedrate Override % (as controlled by the **FEED ↑** and **FEED ↓** keys) is shown at the bottom of the Information Area.
- The conversation line will show all appropriate messages.
- The **TRAKING** soft key (lit only in a STOP condition) activates the TRAKING feature (see Section 10.5).
- The **SHOW ABS** soft key (which is automatically assumed if one of the other 3 show keys are not selected) will show the absolute X, Z positions as the part is run. The display will always show the point defined by the intersection of the SET X and SET Z lines from the screen figures in the Set Up mode (except X for a drill is the drill centerline). This is also point X0, Z0 in Section 5.4.
- The **SHOW INC** soft key will show the incremental (or distance to go within the event) X, Z positions as the part is run. The display will always show the point defined by the intersection of the SET X and SET Z lines from the screen figures in the Set Up mode (except X for a drill is the drill centerline). This is also point X0, Z0 in Section 5.4.
- The **SHOW PATH** soft key will show the tool path graphics as the part is run (as described in Section 9.7).
- The **SHOW PROG** soft key will show the programmed data for the event being run, and the next event as the part is run.

The run procedure is very simple. Follow the instructions on the conversation line and proceed by pressing the GO key.

10.4 Program Run Messages

During Program Run, all messages that will help you to run the part will appear in the conversation line. The messages you will usually see are:

Load Tool __ __: Means to load the tool requested and press **GO** to continue.

Run Over: Means that the program run is complete. If you are running a second part which will be fixtured/clamped in the exact same position as the first part, you do not need to relocate the absolute 0 and restart.

Instead, press the NEXT PART soft key when the conversation line states "Run Over" and system will proceed directly to Event 1.

10.5 TRAKING

The TRAKING feature allows you to progress through the program run using either the X *or* Z handwheel to control **both** axes of motion.

The **TRAKING** soft key will be lit whenever the program run is in a STOP condition. Press the **TRAKING** soft key to activate this feature and use as follows:

- a. Rotate the Z handwheel counterclockwise (motion into the part) to move the carriage *AND* cross-slide through the programmed path.
- b. Or, rotate the X handwheel clockwise (motion into the part) to move the carriage *AND* cross-slide through the programmed path.
- c. The F/C, fine/coarse resolution selection is activated.
- d. The faster you move the handwheel, the faster you will move the tool.
- e. If you stop turning the handwheel, the tool will stop.
- f. If you reverse the handwheel, you will move backwards through the program for up to three line segments.
- g. You may use the jog stick to jog away from your programmed position (handy for clearing a stringy chip or making a measurement). Turning the handwheel will bring you back to the programmed position you left in a straight line.
- h. To resume CNC run, press **STOP**. The **TRAKING** and **CNC RUN** soft keys will light. Press the **CNC RUN** soft key and the **GO** key to resume CNC run. Or press **TRAKING** to resume TRAKing.

10.6 Stop

At any time, pressing the STOP key may halt the program. This freezes the program at that point. To continue, press the **GO** key or **TRAKING** soft key.

10.7 Feedrate and Spindle Speed Override

The run feedrate may be changed at any time by pressing the **FEED ↑** or **FEED ↓** keys. Each press increases or reduces the programmed feedrate, as well as rapid by 10%.

The spindle speed (in RPM or SFM or SMM) may be changed at any time by pressing the **SPEED ↑** and **SPEED ↓** keys. Each press increases or decreases the programmed speed by 5%.

10.8 Threading Exceptions

If your program contains a thread event and you are using the TRAKing feature, the CNC run automatically takes over for the actual threading pass. The run reverts to TRAKing to reposition for the next pass or for the next event.

If you cut a thread and then wish to adjust the XMOD for a more precise thread, you may re-run the event without cross-threading the part. However, you may **NOT** change RPM from the first run to the next.

10.9 Data Errors

The Program Mode in Section 7 describes several rules that must be followed to successfully program a part. In addition, a program must make sense geometrically.

Data errors will nearly always be detected when the ProtoTRAK LX3 runs through a program--either as a Trial Run or on an actual part run. They may also be detected in the Set Up mode when using the Draw Part or Tool Path Graphics routines.

Whenever the ProtoTRAK LX3 detects a data error the display will change to a screen typified by the example below.

								> STATUS
<p>EXPLANATION</p> <p>The programmed arc or circle is a point. XZ begin, end, center are the same.</p> <p>SOLUTION</p> <p>Check all XZ dimensions.</p>								> INFORMATION
Data Error 5013 around event 21								> CONVERSATION
							RETURN	> SOFT KEYS

The Conversation Line displays the error number (not necessarily important to you) and the event where the error was detected. This is not necessarily the event which is in error since the system often "looks ahead" to make sure there is compatibility from one event to another.

In addition, an explanation is given for each data error type as well as a suggested solution. Press the **RETURN** soft key to go back to the Select Mode screen, correct your error, and proceed.

10.10 Fault Messages

The ProtoTRAK performs a number of automatic checks or self-diagnostics on itself. If problems are found it will signal you through the display. The conversation line will display "Fault ____". The information area will display an explanation and suggested solution. Press the RETURN key to get back to the Select Mode screen.

11.0 MATH HELP Mode

Prints are, unfortunately, not always drawn and labeled in such a way as to provide all of the points necessary for programming. To minimize this problem, the ProtoTRAK LX3 provides a graphic math help function which can be used to automatically calculate points of intersection, centers of arcs, trig functions, square roots, etc.

11.1 Procedure

To enter the Math Help Mode, press **MODE** and select the **MATH HELP** soft key. The screen will show:

MATH							INCH	> STATUS
A Line-Line Intersection B Line-Arc Intersection C Arc-Arc Intersection D Line-Arc Tangency E Centers, Points, Radius, Angles of Circles F Polar-Cartesian and Other G Calculator-Math/Trig								> INFORMATION
SELECT								> CONVERSATION
A	B	C	D	E	F	G	TYPE #	> SOFT KEYS

If you already know the math help type you want (see Section 11.3) press the **TYPE #** soft key and enter the number and SET.

If you do not know the type, select from A through G using the soft keys.

NOTE: For selections A-F, all X dimensions should be input and read as diameters, not radii.

If, for example, you wish to find the intersection of a straight line and an arc or circle, press the **B** soft key. The screen will show:

MATH Line-Arc Intersection						INCH	> STATUS	
TYPE 13: Find the intersection of a line and an arc when 2 points are known on the line, and the arc's center and radius are known								> INFORMATION
TYPE 14: Find the intersection of a line and an arc when 2 points are known on the line, two points are known on the arc, and the arc radius is known								> INFORMATION
SELECT								> CONVERSATION
13	14						RETURN	> SOFT KEYS

If the information you know about the line and arc correspond to Type 13, then select the **13** soft key. The screen will then show:

MATH Line-Arc Intersection						INCH	> STATUS	
				TYPE 13				> INFORMATION
				X1				> INFORMATION
				Z1				> INFORMATION
				X2				> INFORMATION
				Z2				> INFORMATION
				X CENTER				> INFORMATION
				Z CENTER				> INFORMATION
				R1				> INFORMATION
X1								> CONVERSATION
		DATA FWD	DATA BACK				ABORT TYPE	> SOFT KEYS

Input the known data in the same way you would program an event. When all of the data is entered, the solution (or solutions if there are more than one) will be shown on the left side of the information area.

There are often multiple solutions for geometry problems. For example, in the Type 13 example above, a line will often intersect an arc or circle in two places. In these cases all possible solutions will be calculated and displayed. In most cases a careful inspection of the print and some common sense will tell you which solution applies to your problem.

11.2 Calculator-Math and Trig Procedures

NOTE: For these math calculations in Section 11.2, X must represent its physical dimension, not automatically doubled to show diameter.

If you select soft key **G** from the first screen in Section 11.1, the display will show:

MATH Calculator-Math/Trig						INCH		> STATUS
								> INFORMATION
								> CONVERSATION
+	-	x	/	=	SQUARE ROOT	TRIG	RETURN	> SOFT KEYS

Use the soft keys like a simple calculator, but always press = for each calculation. Press **RSTR** to Clear Entry. For example, for

$$\frac{(3 + 9 - 2) 27}{4.5}$$

press 3 + 9 = - 2 = x 27 = / 4.5 = to get the correct answer = 60

To calculate a square root, press **RSTR**, the number you wish to find the square root of, and the SQUARE ROOT soft key.

To perform trigonometry functions, press the **TRIG** soft key. The display will show:

MATH Calculator-Math/Trig						INCH		> STATUS
								> INFORMATION
								> CONVERSATION
SINE	COS	TAN	ARC SINE	ARC COS	ARC TAN	TRI- ANGLE	RETURN	> SOFT KEYS

To calculate the sine, cosine or tangent of an angle, input the angle in degrees and press the **SINE, COS** or **TAN** soft key.

To calculate the arcsine, arccosine, or arctangent of a number, input the number and press the ARC SINE, ARC COS or ARC TAN soft key to compute the angle in degrees.

Press **TRIANGLE** to find unknown angles or side lengths of a (90 degree) right triangle. The left side of the screen shows a right triangle with sides A, B, C and angles G and H. Simply input the data you know, and when the ProtoTRAK knows enough it will automatically show the rest.

11.3 Math Help Types

NOTE: X should always be given and read in diameter, not radius.

A. Line-Line Intersection

Type 10 : Find the intersection of 2 lines when any 2 points are known on each line.

Type 11: Find the intersection of 2 lines when 2 points are known on one line, one point is known on the other line, and the angle between the lines is known.

Type 12: Find the intersection of 2 lines when 2 points are known on one, one point is known on the other, a radius tangent to both lines is known, and when one of the points on the two known point lines is also on the radius.

B. Line-Arc Intersection

Type 13: Find the intersection of a line and an arc when 2 points are known on the line and the arc's center and radius are known.

Type 14: Find the intersection of a line and an arc when 2 points are known on the line, 2 points are known on the arc, and the radius is known.

C. Arc-Arc Intersection

Type 15: Find the intersection of 2 arcs when the center and radius of each are known.

D. Line-Arc Tangency

Type 16: Find the intersection of a line tangent to 2 arcs when the centers and radii of each are known.

Type 17: Find the intersection of a line tangent to an arc when one point is known on the line and the arc's center and radius are known.

Type 18: Find the intersection of a line tangent to 2 arcs when the centers and radii of each are known. Line crosses centers.

Type 19: Find the intersection of an arc tangent to 2 other arcs when the centers and radii of the 2 are known, and the radius of the first is known.

E. Centers, Points, Radius and Angles of Circles

Type 20: Calculate the center of an arc when 2 points on the arc and its radius are known.

Type 21: Calculate a point on an arc when the center, another point on the arc, and the angle between the arc points are known.

Type 22: Calculate the radius of an arc or circle when one point on the arc and the center are known.

Type 23: Calculate the center of an arc or circle when 2 points on the arc and the angle between them are known.

Type 24: Calculate the center and radius of an arc or circle when 3 different points on the arc or circle are known.

F. Polar-Cartesian, Other

Type 25: Calculate the cartesian (X and Z) location when the polar (R and angle) coordinates are known.

Type 26: Calculate the decimal angle from an angle given in degrees, minutes, and seconds.

Type 30: Calculate ipm (mmpm) or ipr (mmpr) when one and the RPM is known.

Type 31: Calculate RPM or Surface Speed (SFM or SMM) when one and the diameter is known.

12.0 Program In/Out Mode

You may store and retrieve programs in two different ways:

1. The ProtoTRAK LX3 has two built-in floppy disk drives. One holds the system's operating software and is not accessible. The other is accessible through a door in the computer cabinet and can store 192 moderate size programs.
2. You may store and retrieve programs through an RS232 link to most computers. The RS232 port is located on the back of the pendant box. This same link is used to load programs which have been written via a CAD/CAM system.

All programs are transmitted through the ProtoTRAK LX3's current or computer program memory. Programs are sent from the computer memory (that is, a current program) to one of the above two permanent memory locations. Or programs are retrieved from one of the two, and loaded into the ProtoTRAK LX3's computer memory. Programs may not be sent directly from one of the above two storage devices to another.

Note: The programs will be saved under the LX2 extension. See the note below.

12.1 Cautions About Storing and Retrieving Programs

Care must be taken to keep from losing a program you wish to keep. This can happen two ways.

First, whenever a program is retrieved, it is loaded into the ProtoTRAK LX3's computer program memory. When this happens, your existing current program is erased. Therefore, if your current program is one you want to keep, be certain to store it before you retrieve another program.

Second, to store a program it must have a part number so that the ProtoTRAK LX3 can find it if you want it retrieved. However, no two programs can have the same part number (how would the system decide which to retrieve?). Therefore, if you store a program with any particular part number, it will automatically erase any other program with that same part number.

Note: All old LX2 software generations are compatible with the speed-controlled software. The speed programming lines that are not available on old LX2 software will be filled in with an arbitrary value when that program is retrieved. The programmer must edit the program to fill in the desired speeds and feeds. Backward compatibility, from speed programmed software to non speed programmed software, is also possible, but the feedrates will need to be reprogrammed. To ensure accuracy, thoroughly check the program before running it on the LX2 control.

12.2 Program Formats and Labeling

The ProtoTRAK LX3 has its own unique programming system--one that organizes the program into events rather than codes and blocks. Most CAD/CAM systems output their programs in an RS274 format--commonly referred to as a G-code format.

The ProtoTRAK LX3 software will accept an RS274 CAD/CAM generated program (as configured through a post processor similar to a Fanuc 6T) and convert it to an LX3 event type program. This can occur by directly downloading the program through an RS232 connection from your personal computer to the ProtoTRAK LX3 (see Section 12.6) or by transferring your personal computer floppy disk directly to the LX3 accessible floppy disk drive.

12.3 Enter Program In/Out Mode

Press **MODE**, and select the **PROGRAM IN/OUT** soft key. The display will show:

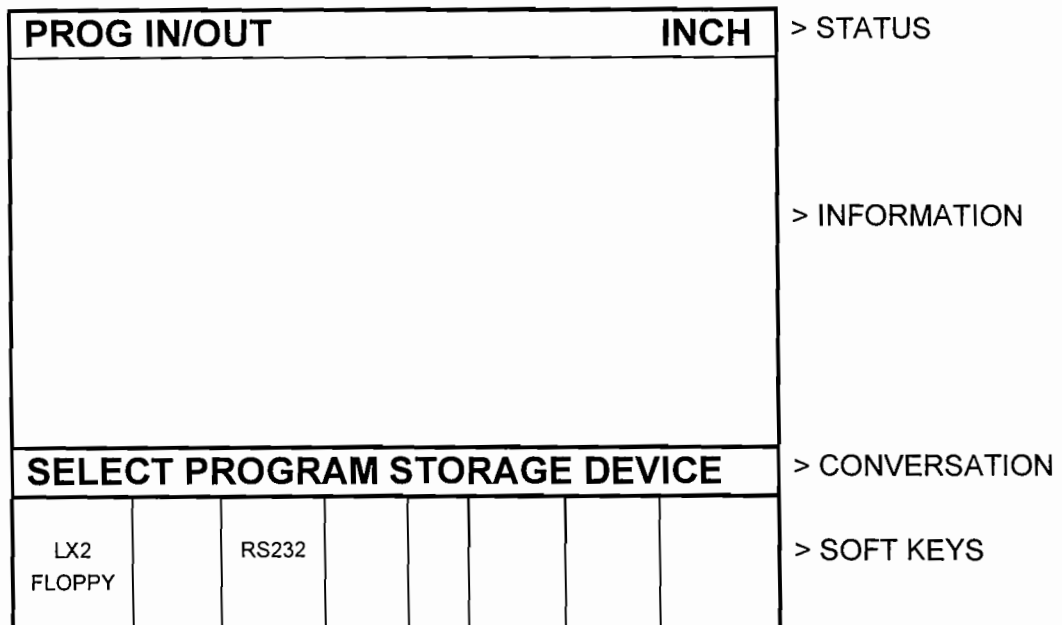

Where:

LX2 FLOPPY: selects the ProtoTRAK LX3's built-in floppy disk drive

RS232: selects a computer via the RS232 port

12.4 Storing and Retrieving Programs from the ProtoTRAK LX3 Built-In Floppy Disk Drive

When you select the **LX2 FLOPPY** soft key from the screen shown in Section 12.3, the display will show:

PROG IN/OUT		PT LX3		INCH		> STATUS
1	LX2					
6	LX2					
24	LX2					
97	LX2					
132	LX2					> INFORMATION
841	CAM					
2492	LX2					
8725	CAM					
15029	LX2					
28197	LX2					
87132	LX2					
252841	CAM					
PART NUMBER 12345						> CONVERSATION
STORE	RETRV LX2	RETRV CAM	ERASE	PAGE FWD	PAGE BACK	RETURN > SOFT KEYS

Where:

- All part numbers in the ProtoTRAK LX3 floppy disk are listed in the Information Area. The listing shows the part numbers followed by LX2 or CAM. Programs are saved under the LX2 extension so that they can be loaded into the LX3 from the ProtoTRAK LX2 control.
- The part number of the current program is shown in the conversation line.
- The **PAGE FWD** (Forward) soft key will continue the part number list if there are too many to be shown on the screen.
- The **PAGE BACK** soft key will shift back the part number list if there are too many to be shown on the screen.
- The **RETURN** soft key will bring back the screen in Section 12.3.

If you wish to **store a program**:

- a. Check the part number shown in the conversation line. It may be edited by inputting the part number you wish.

- b. Press the **STORE** soft key. The stored part number will be added to the list.

If you wish to **retrieve a program**:

- a. Input the part number so it is shown in the conversation line. Be certain it is a part number in the list.
- b. Press the **RETRV LX2** soft key if the part is labeled as one generated by the LX2 or LX3. This program will now be your current program.
- c. Press the **RETRV CAM** soft key if the part is labeled as one generated with a CAM (see Section 12.6). This program will now be your current program.

If you wish to **erase a program** from the list:

- a. Input the part number so it is shown in the conversation line. Be certain it is a part number in the list.
- b. Press the **ERASE** soft key. The program will be permanently erased from the floppy disk and the part number will be eliminated from the list.

12.5 Backing Up Your LX3 Programs

It is strongly recommended that important programs not be solely stored on the LX3 accessible floppy disk drive. A back-up may be made in two ways:

- a. Remove the LX3 accessible floppy diskette that holds the part programs and, using an IBM compatible computer, make a copy or store the data on its hard drive.
- b. Use the RS232 link (see Section 12.6) to transfer programs to your computer for storage.

If at any time you feel the program data on the LX3 floppy diskette is lost or damaged, use your back-up to reproduce the programs.

12.6 Storing and Retrieving Programs through the RS232 Port - Including CAD/CAM Generated Programs

If you wish to use the RS232 port to communicate between your ProtoTRAK LX3 and your computer, call the Customer Service Group at Southwestern Industries and let us know what computer you wish to interface to. The telephone number is 310/608-4422.

You will be sent the necessary equipment and installation instructions at no cost. Please be certain the installation is correct before attempting to use the RS232 Store and Retrieve functions.

When you select the **RS232** soft key from the screen in Section 12.3, the display will show:

PROG IN/OUT		INCH		> STATUS
				> INFORMATION
PART NUMBER 12345				> CONVERSATION
STORE	RETRVE LX2	RETRVE CAM		RETURN > SOFT KEYS

Where:

- The part number of the current program is shown in the conversation line.
- The **RETURN** soft key will bring back the screen in Section 12.3.

If you wish to **store a program**:

- a. Be certain the program you wish to store is in the LX3 current or computer memory. It does not matter what part number is shown since the stored part number is assigned at the personal computer (see "d" below)
- b. Be certain the communication port of the computer is properly configured. For IBM PC compatible computers, type MODE COM1:4800,e,7,1
- c. At the computer, type COPY COM1, the program part number, and the "ENTER" key. For example, COPY COM1 12345, then press ENTER. If you have a computer that is not IBM compatible, use the standard send message.

- d. At the ProtoTRAK LX3 press the **STORE** soft key. The program will be sent, and the conversation line will read "STORING." When complete, the screen will revert to the one shown in Section 12.3.

If you wish to **retrieve a program** that has been stored or written by a CAD/CAM system:

- a. Input the part number you wish the program to be assigned in the LX3.
- b. Press the **RETRVE LX2** soft key if the program you wish to retrieve is in the LX3 event type format. Press the **RETRVE CAM** soft key if the program you wish to retrieve is in the CAD/CAM, RS274, G-code format.
- c. Be certain the communication port at the computer is properly configured. For IBM PC compatible computers, type MODE COM1:4800,e,7,1

Note: If you write a program using a CAD/CAM system on your computer and intend to enter it into the ProtoTRAK LX3 via the RS232 port, you must name the program with one to eight numerical digits followed by a decimal point, followed by CAM (for example, 123.CAM or 87654321.CAM). If these rules are not followed the LX3 will not recognize the program.

- d. At the computer, type COPY, the program part number, COM1 and the ENTER key. For example, COPY 12345.LX2 COM1, then press ENTER. If you have a computer that is not IBM compatible, use the standard send procedure.
- e. When the program has been completely received by the LX3, the screen will revert to the one shown in Section 12.3.

Note: Do not attempt to write LX3 formatted programs through your CAD/CAM programming system.

Remember, all LX3 programs are saved under the LX2 extension.

