

TRAK® LPM

Programming, Safety, and Operating Manual

Document: 26728 Version: 051013



Southwestern Industries, Inc.

2615 Homestead Place

Rancho Dominguez, CA 90220-5610 USA

T | 310-608-4422 | F | 310-764-2668

Service Department: 800.367.3165

e-mail: sales@southwesternindustries.com | service@southwesternindustries.com | web: southwesternindustries.com

Copyright © 2013, Southwestern Industries, Inc. All rights are reserved. No part of this publication may be reproduced, stored in a retrieval system, or transmitted, in any form or by any means, mechanical, photocopying, recording or otherwise, without the prior written permission of Southwestern Industries, Inc.

While every effort has been made to include all the information required for the purposes of this guide, Southwestern Industries, Inc. assumes no responsibility for inaccuracies or omission and accepts no liability for damages resulting from the use of the information contained in this guide.

All brand names and products are trademarks or registered trademarks of their respective holders.

Table of Contents

1.0	Introduction		
1.1	Manual Organization	1	
2.0	Safety		
2.1	Safety Publications	3	
2.2	Danger, Warning, Caution and Note Labels and Notices Used in this Manual		
2.3	Safety Precautions		
3.0	Description	10	
3.1	Control Specification		
3.1.1	ProtoTRAK PMX Hardware Specifications		
3.1.2	ProtoTRAK PMX Software Specifications		
3.1.3	ProtoTRAK PMX Control Options		
3.1.4	DXF File Converter Option		
3.1.5	CAM Out Option		
3.1.6	How to Buy Software Options		
3.2	Display Pendant		
3.2.1	Program Panel		
3.2.2	Run Panel		
3.2.3	Pendant Right Side		
3.3	Machine Description		
3.3.1	Overall Machine Dimensions		
3.3.2	Machine Specifications		
3.3.3	Maximum Spindle Torque and Horsepower		
3.3.4	Electrical Cabinet		
3.3.5	Computer Module		
3.3.6	Servo Motors		
3.3.7	Servo Drives		
3.3.8	Spindle		
3.3.9	Spindle Motor & Drive		
3.3.10	Automatic Draw Bar Assembly		
3.3.11	Retention Knobs		
3.3.12	Tool Changer		
3.3.13	Drive Train, Axes		
3.3.14	Worktable		
3.3.15	Limit/Home Switches		
3.3.16	Lubrication System		
3.3.17	Coolant and Coolant Wash System		
3.3.18	Pneumatic System		
3.3.19	Enclosure Doors		
3.3.20	Beacon Lights		
3.3.21	Chip Removal System		
3.3.22	Work Lamps		
4.0	Basic Operation	27	
4.1	Machine and Control Power On		
4.2	Control and Power Off		
4.2.1	Energizing the Servos		
4.2.2	Homing the Machine		
4.2.3	Warming Up the Machine		
4.2.4	Current and Staged Control Views		
4.3	Spindle Operation		
4.4	Electronic Handwheel		
4.4.1	Manual Axis Movement		
4.4.2	Feed Override		
4.4.3	Spindle Override		
4.5	Multiple Uses of the GO Button		
4.6	Multiple Uses of the STOP Button		
4.7	Emergency Stop		
4.8	Enclosure		
4.8.1	Front Door		
4.8.2	Side Doors		
4.8.3	Positioning the Control Panel		
4.9	Coolant		
4.9.1	Coolant ON/OFF		
4.9.2	Coolant Wash		
4.9.3	Coolant Hose		
4.9.4	Checking Coolant Levels		
4.10	Air		
4.10.1	Air Hose		
4.10.2	Air Blast		
4.10.3	Checking Air Pressure		
4.11	Chip Removal		
4.11.1	Auger Operation		
4.12	ATC Operation		
4.12.1	Advancing the Carousel		
4.12.2	Manual Tool Load and Unload		
4.13	Lubrication		
4.14	Help Functions		
4.14.1	Math Helps		
5.0	Definitions, Terms & Concepts	34	
5.1	ProtoTRAK PMX CNC Axis Conventions		
5.2	Part Geometry and Tool Path Programming		
5.3	Planes and Vertical Planes		
5.4	Absolute and Incremental Reference		
5.5	Referenced and Non-Referenced Data		
5.6	Incremental Reference Position in Programming		
5.7	Tool Diameter Compensation		
5.8	Tool Diameter Compensation When Contouring in Z with Part Geometry		
5.9	Connective Events		
5.10	Conrad		
5.11	Memory and Storage		
5.12	Current and Staged Views		
6.0	DRO Mode	42	
6.1	Entering Dimensions		
6.2	Reference Locations		
6.3	Power Feed		
6.4	GO TO		
6.5	Return to Absolute Zero		
6.6	Spindle Operation		
6.7	Axis Motion in the DRO Mode		

7.0	Program Mode Part 1: Getting Started & General Information	46			
7.1	Programming Overview			9.4	Skipping Over Prompts
7.2	Enter Program Mode			9.5	The OK/NOT OK Flag
7.3	Program Header Screen			9.6	Ending A.G.E.
7.3.1	Program Name			9.7	Guessing Data
7.3.2	General Program Options			9.8	LOOK and Guess
7.3.3	Program Header Softkeys			9.9	Calculated Data
7.4	Assumed Inputs			9.10	Arcs and Conrads
7.5	Z Rapid Positioning			9.11	Tangency
7.6	Softkeys within Events			10.0	Edit Mode
7.7	Programming Events			10.1	Delete Events
7.8	Editing Data While Programming			10.2	Spreadsheet Editing
7.9	LOOK			10.2.1	Selecting Data to be displayed on the Search Edit Table
				10.2.2	Sorting Data
8.0	Program Mode Part 2: Program Events	54		10.2.3	Making Global Changes to Data
8.1	POSN: Position Events			10.3	Erase Program
8.2	DRILL Events			10.4	Clipboard
8.3	BOLT HOLE Events			10.5	G-Code Editor
8.4	MILL Events			10.6	Update GCD
8.5	ARC Events			10.7	Next Program
8.6	POCKET Events			11.0	Program Set Up Mode
8.6.1	Circular Pocket			11.1	Part / Fixture Management
8.6.2	Rectangular Pocket			11.1.1	PICTURE
8.6.3	Irregular Pocket			11.1.2	NOTES
8.6.4	Tool Path in Pocket Events			11.1.3	GO TO
8.6.5	Zigzag Z Depth Cuts			11.1.4	Z SAFETY
8.6.6	Conrad in Pocket Events			11.1.5	Part/Fixture Management LOOK
8.6.7	Bottom Finish Cut			11.2	Tool Management
8.6.8	Face Mill Event			11.2.1	TOOL CRIB
8.7	ISLAND Events			11.2.2	REMOVE TOOL
8.7.1	Circular Island			11.2.3	NOTES
8.7.2	Rectangular Island			11.2.4	DISABLE LOC
8.7.3	Irregular Island			11.3	TOOL PATH
8.8	PROFILE Events			11.3.1	Softkeys in Tool Path
8.8.1	Circle Profile			11.4	Run Strategy
8.8.2	Rectangular Profile			11.5	Tool Recon (Reconciliation)
8.8.3	Irregular Profile			12.0	Machine Set Up Mode
8.9	HELIX Events			12.1	Tool Loading
8.10	Subroutine Events			12.1.1	Tool Status Box
8.10.1	REPEAT			12.1.2	Tool Loading Table
8.10.2	MIRROR			12.1.3	REMOVE TOOL
8.10.3	ROTATE Z Axis			12.1.4	ADD TOOL
8.11	COPY Events			12.1.5	CALL TOOL
8.11.1	Copy Drill to Tap			12.1.6	RETURN TOOL
8.12	THREAD MILL Event			12.1.7	RESET ATC
8.13	PAUSE Events			12.2	Checklist
8.14	TAP Events			12.3	Service Codes
8.14.1	Tapping Notes & Recommendations			13.0	Run Mode
8.15	ENGRAVE Event			13.1	Run Mode Screen
8.16	Auxiliary (AUX) Functions Event			13.2	Starting to Run
				13.2.1	Starting to Run – Single Program
9.0	Program Mode Part 3: The Auto Geometry Engine (A.G.E) Programming	79		13.2.2	Starting to Run – Master Program
9.1	Starting the A.G.E.			13.3	Program Run
9.2	A.G.E. Mill Prompts			13.4	TRAKING
9.3	A.G.E. Arc Prompts			13.5	Program Run Messages
				13.6	STOP

- 13.7 Feedrate and Speed Overrides
- 13.8 Data Errors

14.0 Program In/Out Mode 126

- 14.0.1 Filenames and File Extensions
- 14.1 Softkey Selections in the Program In/Out Mode
- 14.2 Basic Navigation of Program In/Out Mode Screens
 - 14.2.1 Basic Parts of the Program In/Out Mode Screens
 - 14.2.2 Softkeys in the Program In/Out Mode Screens
- 14.3 Opening a File
 - 14.3.1 Creating a Master Program
 - 14.3.2 Preview Graphics
- 14.4 Saving Programs
- 14.5 Copying Programs
- 14.6 Deleting Programs
- 14.7 Renaming
- 14.8 Backing Up
- 14.9 **Converters™**
 - 14.9.1 Activating Converters
 - 14.9.2 Converting From a Different Format into a ProtoTRAK PMX CNC
 - 14.9.3 Converting From the ProtoTRAK PMX CNC to a Different Format
- 14.10 ProtoTRAK and TRAK CNC Compatibility
 - 14.10.1 File Formats
 - 14.10.2 Opening .MX3 and .PT4 files on a ProtoTRAK PMX CNC
 - 14.10.3 Running ProtoTRAK PMX Files on ProtoTRAK and TRAK CNC Controls
- 14.11 Running G Code Files (GCD)
 - 14.11.1 G Codes Recognized by the ProtoTRAK PMX GCD Converter
 - 14.11.2 M Codes Supported by the ProtoTRAK PMX CNC
 - 14.11.3 Valid Characters for Word/Address Sequences
- 14.12 Networking
 - 14.12.1 A Basic Peer-To-Peer Network
 - 14.12.2 Assigning a Name and Selecting a Workgroup
 - 14.12.3 Mapping Network Drive
 - 14.12.4 General Information For Advanced Networks
- 14.13 CAD/CAM and Post Processors
 - 14.13.1 Writing a Post Processor
 - 14.13.2 Convertible G-Codes for CAM converter
 - 14.13.3 Supported Addresses
 - 14.13.4 Format Terms and Definitions
 - 14.13.5 Accepted M Codes

15.0 4th Axis Option 156

- 15.1 4th Axis Specifications
- 15.2 Definitions, Terms, and Concepts
 - 15.2.1 Direction of 4th axis
 - 15.2.2 Feed rate
- 15.3 DRO Mode
 - 15.3.1 JOG
 - 15.3.2 GO TO
 - 15.3.3 RETURN ABS 0
 - 15.3.4 SET A
 - 15.3.5 REF 4th Axis
- 15.4 PROG Mode

- 15.4.1 POSN
- 15.4.2 MILL 4 AXIS
- 15.4.3 ENGRAVE 4 AXIS
- 15.4.4 AUX Event
- 15.4.5 LOOK
- 15.5 PROG SETUP Modes
 - 15.5.1 PART/FIX MGMT Screen
 - 15.5.2 Tool Path
- 15.6 MACHINE SETUP Mode
 - 15.6.1 SERV CODES Screen
 - 15.6.2 4th AXIS ON / OFF
- 15.7 PROG I/O
 - 15.7.1 4th Axis G-Code notes
- 15.8 4th Axis Setup Notes

1.0 Introduction

Congratulations! Your TRAK LPM Milling Machine with the ProtoTRAK PMX CNC is a brand new concept in smaller lot production. It combines the simplicity of the ProtoTRAK programming method with innovative systems in tooling, workholding and job management.

The TRAK LPM is more than a machine. It is a system of machining that helps you to reduce set ups for smaller run production jobs.

This manual will describe the operation of the machine and the ProtoTRAK PMX CNC.

1.1 Manual Organization

Section 2 of this manual provides important safety information. It is highly recommended that all operators of this product review this safety information.

Section 3 provides a description of the TRAK LPM and the ProtoTRAK PMX CNC.

Section 4 describes the operation of the milling machine and some basic operations of the ProtoTRAK PMX CNC.

Section 5 defines some terms and concepts useful in learning to program and operate the ProtoTRAK PMX CNC.

The ProtoTRAK PMX CNC is organized into seven Modes of operation that are described in the following sections.

Section 6 DRO: Digital Readout and power feed operations.

Section 7 Programming, Part 1: covers some general programming information and instructions on starting new programs.

Section 8 Programming, Part 2: Program Events - instructions for the canned cycles, or events, used to program the ProtoTRAK PMX CNC.

Section 9 Programming, Part 3: the A.G.E., or Auto Geometry Engine, so powerful it gets its own section.

Section 10 Edit: for routines to make large-scale changes to programs in current memory, including the powerful Spreadsheet Editing®

Section 11 Program Set Up: Where you can do those set up operations that are possible with the machine running a different job.

Section 12 Machine Set Up: The few operations you must do with the machine idle as you make the final preparations to run your new job. Also includes the powerful Checklist so that you can be sure you haven't overlooked anything.

Section 13 Run: Instructions on running a program to machine your part.

Section 14 Program In/Out: Storing and managing your programs as well as creating a Master Program.

Section 15 4th Axis Option: Instructions on how to run and program a 4th axis option.

2.0 Safety

The safe operation of the LPM depends on its proper use and the precautions taken by each operator.

- Read and study this manual and the LPM Programming, Operating, and Care Manual. Be certain every operator understands the operation and safety requirements of this machine *before* its use.
- Never run the machine with enclosure doors open
- Always wear safety glasses and safety shoes.
- Always stop the spindle and check to ensure the CNC control is in the stop mode before changing or adjusting the tool or workpiece.
- Never wear gloves, rings, watches, long sleeves, neckties, jewelry, or other loose items when operating or around the machine.
- Use adequate point of operation safeguarding. It is the responsibility of the employer to provide and ensure point of operation safeguarding per OSHA 1910.212 - Machining centers.

2.1 Safety Publications

Refer to and study the following publications for assistance in enhancing the safe use of this machine.

Safety Requirements for Machining Centers and Automatic, Numerically Controlled Milling, Drilling and Boring Machines (ANSI B11.23-2002) (R2007). Available from The American National Standards Institute, 1819 L Street N.W., Washington D.C. 20036

Concepts And Techniques Of Machine Safeguarding (OSHA Publication Number 3067). Available from The Publication Office - O.S.H.A., U.S. Department of Labor, 200 Constitution Avenue, NW, Washington, DC 0210.

2.2 Danger, Warning, Caution, and Note Labels & Notices As Used In This Manual

DANGER - Immediate hazards that **will** result in severe personal injury or death. Danger labels on the machine are red in color.

WARNING - Hazards or unsafe practices that *could* result in severe personal injury and/or damage to the equipment. Warning labels on the machine are orange in color.

CAUTION - Hazards or unsafe practices, which *could* result in minor personal injury or equipment/product damage. Caution labels on the machine are yellow in color.

NOTE - Call attention to specific issues requiring special attention or understanding.

HELPFUL TIP- A technique or tool that can aid you.

**Safety & Information Labels Used On The
LPM Milling Machine**

***It is forbidden by OSHA regulations and by law to deface, destroy or
remove any of these labels***



i01434

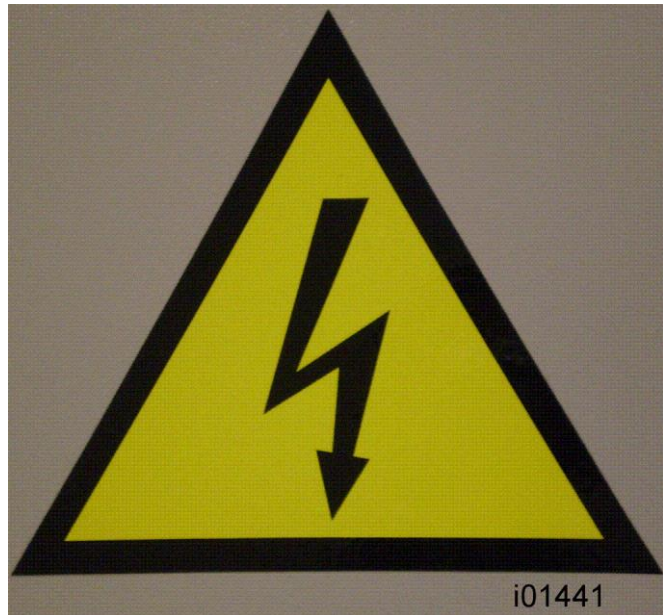

i01441



i01437



i01438

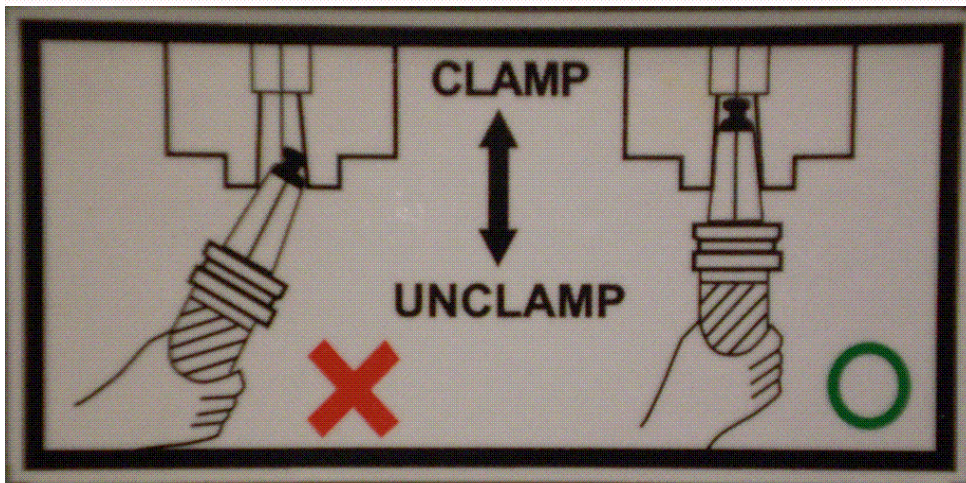

i01435



i01439

Air pressure setting	
Max.pressure setting	115psi / 8kg/cm ²
Min.pressure setting	70psi / 5kg/cm ²
Pressure sensor setting	60psi / 4 kg/cm ²

i01436

SAFETY INSTRUCTIONS

1. Read and understand Operator's Manual and all warnings on the sign before operating.
Failure to follow these instructions and warnings can result in serious injury or death.
2. This machine starts and moves automatically.
Never place any part of your body near or on moving parts of this machine.
3. Always stop the spindle completely before touching the work piece, tool or spindle.
4. Do not operate this machine unless all guards, interlocks and other safety devices are in place and functioning.
5. Always clamp work piece and cutting tool securely. avoid excessive feeds and spindle speeds.
6. Remove rings, watches, jewelry and loose fitting clothing.
Keep your hair away from moving parts of the machine.
7. Always wear safety glasses, safety shoes and hearing protection when operating this machine.
8. Service or installation of this machine must be performed by qualified personnel only, following procedures described in the Maintenance Manual. Turn off and lock out power at main electrical panel before servicing.

It is the responsibility of the user to be sure that this machine is in safe operating condition at all times and that the operator follows the safe operating procedures described in the Operator and Maintenance Manuals and all signs attached to this machine. If you have any questions concerning the safe operation of this machine, contact your supervisor or local Distributor.

Please do not remove or disfigure this sign.

i01440

WARNING

- IMPROPER OPERATION OR IMPROPER MAINTENANCE OF THIS MACHINE MAY CAUSE SERIOUS BODILY INJURY.
- DO NOT OPERATE THIS MACHINE UNTIL YOU HAVE RECEIVED OPERATING AND SAFETY INSTRUCTIONS FROM YOUR EMPLOYER.
- FOLLOW ALL SAFETY PRACTICES PRESCRIBED BY YOUR EMPLOYER AND OUTLINED IN THE PROGRAMMING, OPERATING AND CARE MANUAL.
- ALWAYS AVOID UNSAFE OPERATING CONDITIONS SUCH AS EXCESSIVE FEEDS AND SPEEDS.
- ALWAYS BE SURE ALL SAFETY DEVICES ARE IN GOOD OPERATING CONDITION (SEE MANUAL).
- ALWAYS BE CERTAIN THAT SERVICE IS PERFORMED ONLY BY QUALIFIED PERSONNEL.
- IT IS THE RESPONSIBILITY OF THE EMPLOYER TO PROVIDE AND ENSURE POINT OF SAFEGUARDING PER ANSI B11.6-1984 (R1994) & ANSI B11.8-1983 (R1994).
- THE MANUFACTURER IS NOT LIABLE (RESPONSIBLE) FOR ANY DAMAGE OR INJURY OF ANY KIND TO PERSONS OR PROPERTY CAUSED BY OR RESULTING FROM THE IMPROPER OR UNAUTHORIZED USE, OPERATION, MAINTENANCE, ALTERATION, MODIFICATION, CHANGE IN CONFIGURATION OF THIS MACHINE OR ANY OF ITS COMPONENTS, PARTS, OR THE USE OF THIS UNIT WITH ANY THIRD PARTY ACCESSORIES OR PARTS.

DO NOT REMOVE THIS SIGN FROM MACHINE.

i22774

2.3 Safety Precautions

1. Do not operate this machine before the **LPM Installation, Maintenance, Service and Parts List Manual, Operating & Care Manual** have been studied and understood.
2. Do not run this machine without knowing the function of every control key, button, knob, or handle. Ask your supervisor or a qualified instructor for help when needed.
3. Protect your eyes. Wear approved safety glasses (with side shields) at all times.
4. Don't get caught in moving parts. Before operating this machine remove all jewelry including watches and rings, neckties, and any loose-fitting clothing.
5. Keep your hair away from moving parts. Wear adequate safety headgear.
6. Protect your feet. Wear safety shoes with oil-resistant, anti-skid soles, and steel toes.
7. Take off gloves before you start the machine. Gloves are easily caught in moving parts.
8. Remove all tools from the machine before you start. Loose items can become dangerous flying projectiles.
9. Never operate a milling machine after consuming alcoholic beverages, or taking strong medication, or while using non-prescription drugs.
10. Protect your hands. Stop the machine spindle and ensure that the CNC control is in the stop mode:
 - Before changing tools
 - Before changing parts
 - Before you clear away the chips, oil or coolant. Always use a chip scraper or brush.
 - Do not use compressed air to clean the machine.
 - Before you make an adjustment to the part, fixture, coolant nozzle or take measurements.
 - Do not attempt to disable any safety interlock. Never reach around a safeguard.
11. Protect your eyes and the machine as well.
12. Disconnect power to the machine before you change belts, pulley, and gears.
13. Keep work areas well lighted. Ask for additional light if needed.
14. Do not lean on the machine while it is running.
15. Prevent slippage. Keep the work area dry and clean. Remove the chips, oil, coolant and obstacles of any kind around the machine.
16. Avoid getting pinched in places where the table, saddle or spindle head create "pinch points" while in motion.
17. Securely clamp and properly locate the workpiece in the vise, on the table, or in a fixture. Use stop blocks to prevent objects from flying loose. Use proper holding clamping attachments and position them clear of the tool path.
18. Use correct cutting parameters (speed, feed, depth, and width of cut) in order to prevent tool breakage due to premature wear.

19. Use proper cutting tools for the job. Pay attention to the rotation of the spindle: As viewed from above, left hand tool for counterclockwise rotation of spindle, and right hand tool for clockwise rotation of spindle.
20. To prevent damage to the workpiece or the cutting tool, never start the machine (including the rotation of the spindle) if the tool is in contact with the part.
21. Check the direction (+ or -) of movement of the table when using the jog feature, clockwise rotation of the EHW moves the axis in the positive direction, counterclockwise in the negative direction.
22. Don't use dull or damaged cutting tools. They break easily and become airborne. Inspect the sharpness of the edges, and the integrity of cutting tools and their holders. Use proper length for the tool.
23. Inspect the retention knobs for damage or excessive wear before each use.
24. Large overhang on cutting tools when not required result in accidents and damaged parts.
25. Prevent fires. When machining certain materials (magnesium, etc.) the chips and dust are highly flammable. Obtain special instruction from your supervisor before machining these materials.
26. Prevent fires. Keep flammable materials and fluids away from the machine and hot, flying chips.

Warning

Retention knobs come in a wide variety of designs, however they often look similar and appear to be interchangeable, but they are not. Use only the knob that the LPM is designed to use. The use of the incorrect knob, or the incorrect usage of a knob, may result in injury or property damage.

To ensure the correct knob is chosen, please refer to section 3.3.11, Machine Major Subassemblies section of this manual

3.0 Description

This section will provide an overview of features and specifications found on the TRAK LPM.

3.1 Control Specifications

The new ProtoTRAK PMX CNC retains the basic operations strategies found in all other models of ProtoTRAK and TRAK CNCs.

3.1.1 ProtoTRAK PMX Hardware Specifications

Jog wheel for TRAKing and positioning

12.1" color active-matrix screen

Industrial-grade Celeron® processor

512 MB Ram

4 User USB connectors

Override of program feedrate

LED status lights built into display

RJ45 Port with 10/100 Ethernet

Override of program spindle speed

4th axis interface

Program storage via a USB flash drive installed in a port in the electrical cabinet.

3.1.2 ProtoTRAK PMX Software Specifications

Software Features - General Operation:

- Clear, uncluttered screen display
- Prompted data inputs
- English language – no codes
- Soft keys - change within context
- Windows® operating system
- Color graphics with adjustable views
- Inch/mm selectable
- Convenient modes of operation
- Absolute Home location
- Spindle load indicator
- Reference to ball lock locations on table
- Dimension reference indicator
- Selectable view between Current and Staged programs

DRO Mode features:

- Incremental and absolute dimensions
- Jog with selectable feed rates
- Powerfeed X, Y or Z
- Servo return to 0 absolute
- Go To Dimensions from convenient reference
- Spindle speed setting with manual override
- Selectable handwheel resolution

- Convenient choice of dimensional references:
Machine Home, Part Zero, Abs Zero and Ball Lock locations

Program Mode Features

- Auto Geometry Engine
- Geometry-based programming
- Tool Path programming
- Scaling of print data
- Multiple fixture offsets
- Programming of Auxiliary Functions
- Event Comments
- Three-axis Geometry conversational programming
- Incremental and absolute dimensions
- Automatic diameter cutter comp
- Circular interpolation
- Linear interpolation
- Look –graphics with a single button push
- List step – graphics with programmed events displayed
- Alphanumeric program names
- Program data editing
- Program pause
- Conrad – automatic corner radius
- Programmable spindle speeds
- Math helps with graphical interface
- Auto load of math solutions
- Tool step over adjustable for pocket routines
- Pocket bottom finish pass
- Selectable ramp or plunge cutter entry
- Subroutine repeat of programmed events
- Nesting
- Rotate about Z-axis for skewing data
- Mirror of programmed events
- Copy
- Copy rotate
- Copy mirror
- Tool data entry in event programming
- Selectable retract in Bore operations

Auxiliary Functions

- Coolant on/off
- Air on/off
- Pulse indexer
- Part change table position

Canned Cycles

- Position

- Drill
- Bolt Hole
- Mill
- Arc
- Circle pocket
- Rectangular pocket
- Irregular Pocket
- Circular profile
- Rectangular profile
- Irregular Profile
- Circle Island
- Rectangular Island
- Irregular Island
- Helix
- Thread milling
- Engrave
- Tapping
- Face Mill

Edit Mode Features

- Delete events
- Erase program
- Spreadsheet editing
- Global data change
- G-Code editor
- Clipboard to copy events between programs
- Move between subprograms in a master program

Program Set Up Mode Features

- Program diagnostics
- Advanced tool library
- Tool names
- Tool length offset with modifiers
- Tool diameters with modifiers
- Tool path graphics with adjustable views
- Program run time estimation clock
- Convenient part/fixture management screen
- Fixture offsets
- Part offsets within fixture
- Convenient manual tool handling when tools required exceed ATC capacity
- Photo storage and display
- Notes
- Z Safety Dimension to prevent crashes
- Tool Crib
- Tool by Tool or Part by Part run strategy
- Convenient Tool Reconciliation between programs and ATC

- Convenient ATC capacity

Machine Set Up Mode Features

- Advanced diagnostic routines
- Software travel limits set in the factory
- Prompted Tool loading and ATC Management
- Checklist to assure nothing is forgotten
- Single key press to get to step needing attention

Run Mode Features

- TRAKing
- 3D CAM file program run
- 3D G code file run with tool comp
- Real time run graphics with tool icon
- Countdown clock for total part cycle time or manual tool change
- Error alarms prevent Run when set up steps are skipped
- Work on Staged programs while Current program runs

Program In/Out Mode Features

- CAM program converter
- Converter for prior-generation ProtoTRAK programs
- DXF/DWG file converter (Optional)
- Selection of file storage locations
- Automatic file back-up routine
- Preview graphics for unopened files
- Networking
- Create Master routine for combining programs
- Transfer of Staged program to Current
- Tool reconciliation for Master Programs

3.1.3 ProtoTRAK PMX Control Options

The DXF File Converter Option

- Import and convert CAD data into ProtoTRAK programs
- DXF or DWG files
- Chaining
- Automatic Gap Closing
- Layer control
- Easy, prompted process you can do right at the machine

CAM Out Converter Option

- Save ProtoTRAK files as CAM files for running on different controls

3.1.4 DXF File Converter Option

The DXF File Converter Option gives you powerful capability for quickly and easily translating DXF and DWG files into ProtoTRAK programs. If you work with CAD drawings, we highly recommend that you get a demo of the DXF file converter.

To tell if the DXF File Converter is active on your ProtoTRAK PMX CNC, go to the options screen using Service Code #318. If the AutoCAD DXF option is in black letters, it is activated. If it is in gray letters, you will need to purchase the option to activate it. The DXF Option consists of an Activation Password, and may require an additional software update. To download the latest version of our DXF software, go to our website at www.southwesternindustries.com then click 'Support & Software' for current ProtoTRAK CNC, and follow the instructions for downloading the software via a USB flash drive. See Section 3.1.6 below for instructions on ordering and obtaining your Activation Password.

The DXF Option has its own manual which is shipped with the software. You may also view a copy of the manual on our web site.

3.1.5 CAM Out Option

Note: CAM file run by bringing a CAM file into the ProtoTRAK PMX is a standard feature.

The CAM out Option gives you the ability to create or modify a program using the easy, intuitive ProtoTRAK interface and then convert that program into a CAM file or G Code file to use to run other CNCs.

Note: you do not need the CAM Out option to share programs between ProtoTRAK CNCs.

To tell if the CAM Out feature is active on your ProtoTRAK PMX CNC, go to the options screen using Service Code #318. If the CAM Out option is in black letters, it is activated. If it is in gray letters, you will need to purchase the option to activate it. The software for the CAM Out Option requires an Activation Password for you to use. See Section 3.1.6 below for instructions on ordering and obtaining your Activation Password.

3.1.6 How To Buy Software Options

If you did not buy the software options described above with your machine, you may purchase them later. In order to use these options, a Software Activation Password is required. These passwords are unique to your ProtoTRAK PMX CNC.

Software Options are not free. You may call your local Southwestern Industries Sales Representative or Southwestern Industries Inside Sales at 310-608-4422 for a price quotation.

1. We recommend that you install the latest version of the ProtoTRAK PMX master software before installing the newest option. See our web site at www.southwesternindustries.com for software downloads.

2. Go to the ProtoTRAK PMX CNC on which the option is to be installed, use Service Code 318 to go to the Software Options Screen.
3. Highlight the option you wish to install and press the softkey labeled INSTALL.
4. A screen will appear that advises you how to purchase the option. Near the bottom of the screen there will be a Hardware Key Serial Number and an Option Serial Number. Write down both of these numbers.
5. Call your Southwestern Industries Sales Representative or the Southwestern Industries Order Desk with your purchase order number and the numbers you wrote down in step 4 above.
6. When you receive your Password Activation Number, input it into the ProtoTRAK where indicated on the screen obtained in step 2 above. Some options require you to reboot the ProtoTRAK to activate.
7. Refer to the appropriate section of this manual for instructions on using your new features.

3.2 Display Pendant

The display pendant is integrated into the TRAK LPM on the front right side of the machine enclosure. The pendant may swing out 80° for your convenience and may be locked in place at 45° and 80°.

3.2.1 Program Panel



The Program Panel is the upper panel on the front of the Pendant.

INC SET: loads incremental dimensions and general data

ABS SET: loads absolute dimensions and general data

RESTORE: clears an entry, aborts a keying procedure
INC/ABS: switches all or one axis from incremental to absolute or absolute to incremental position
IN/MM: causes Inch to Metric or Metric to Inch conversion of displayed data
LOOK: part graphics in Program Mode
MODE: to change from one mode of operation to another
CURSOR: moves cursor of highlight in tables, lists or choices and pages between event.
BACK: shifts LCD screen to previous display
HELP: display help information, Math Help or additional functions. Active for additional functions when the help symbol (a blue question mark) is displayed on the screen next to the HELP key.
C/S: switches Program Panel from current (the part program you are running) to staged (a different part program you are preparing to run in the future) and back. You can tell if you are in current or staged by the color of the Soft Keys: white Soft Keys tell you that you are in the Staged View.

Keyboard Soft Keys:

Beneath the display are 10 keys that are labeled with arrows. These keys are called software programmable or soft keys. A description of the function or use of each of these keys will be shown at the bottom of the display directly above each key. If, at any time, there is no description above a key, that key will not operate.

Sometimes the description or function of the key is visible but grayed out. This indicates that the particular function is not available because of some other condition. For example, if a program is not loaded into memory, then the softkey in Edit mode will be gray.

Emergency Stop Switch

The emergency stop (E-stop) switch kills all power to the spindle and ProtoTRAK's servomotors. The computer and pendant remain powered. To resume working from an emergency stop, you must twist to release the emergency stop button and press the green energize servos button.

The Liquid Crystal Display (LCD)

The display of the ProtoTRAK SMX CNC is a 12.4" active-matrix color LCD. The very top is the Status Line that shows the overall status of the ProtoTRAK SMX CNC.

Status line information includes:

- Current Mode
- Current program part number
- Current tool number
- Whether the X, Y and Z dimensions are in inch or millimeter (mm).

Just above the soft keys is a data input line that appears when an input is required.

3.2.2 Run Panel



The Run Panel is the lower panel on the front of the pendant.

Spindle Keys

FWD: turns the spindle on in the forward direction in DRO Mode

OFF: turns the spindle off in the DRO Mode

REV: turns the spindle on in the reverse direction in the DRO mode

Feed Keys

GO: initiates axis motion in DRO Mode or during a stop condition in Run Mode

STOP: halts axis motion

Electronic Hand Wheel Keys

Electronic Hand Wheel: used to control X, Y, Z axis positioning, spindle rpm override, and axis feed override. There are 100 positions or detents per revolution.

SPINDLE OVERRIDE: enables handwheel to control spindle rpm override from 0 to 150 percent in 2% increments.

FEED OVERRIDE: enables handwheel to control axis feed override from 0 to 150 percent in 2% increments.

EHW: enables handwheel to control positioning along X, Y, Z axes.

X, Y, Z: selects axis to be controlled by Electronic Handwheel.

.0001in / .002mm: selects incremental axis motion per handwheel detent. One revolution equals (.0001in x 100) 0.01in.

.001in / .02mm: selects incremental axis motion per handwheel detent. One revolution equals (.001in x 100) 0.1in.

.01in / .2mm: selects incremental axis motion per handwheel detent. One revolution equals (.01in x 100) 1.0in.

FAST: selects fast axis motion for coarse movement up to 300 ipm.

Auxiliary Function Keys

COOLANT: press to turn coolant on (ON LED is lit). Press again to turn coolant on (AUTO LED is lit) when commanded by the program in Run Mode. Press again to turn coolant off.

AIR: controls air blast from spindle to help clear chips. Press to turn air on (ON LED is lit). Press again to turn air on (AUTO LED is lit) when commanded by the program in Run Mode. Press again to turn air off.

WASH: press to activate chip wash to help move chips down to the chip auger location.

DOOR LOCK: activates the door lock mechanism whenever a program or other automatic move is running. The LED light on the key is on when the door lock mechanism is active (it is possible for the door to be locked without the light being on).

CHIP REMOVAL: press Forward (FWD) to activate chip auger, press again to turn off. Press and hold Reverse (REV) to drive chip auger in reverse to help clear jams (make sure FWD is off).

ATC INDEX: press forward (FWD) to index the automatic tool changer carousel forward by one tool. Press Reverse (REV) to index the automatic tool changer carousel backwards by one tool. The door must be closed.

3.2.3 Pendant Right Side



Inset on the right side of the pendant are four USB ports for the thumb drive, keyboard, mouse, etc. Above these is a green Servo On button that must be pressed to activate machine motion following power start up or after the E Stop button is pressed.

3.3 Machine Description

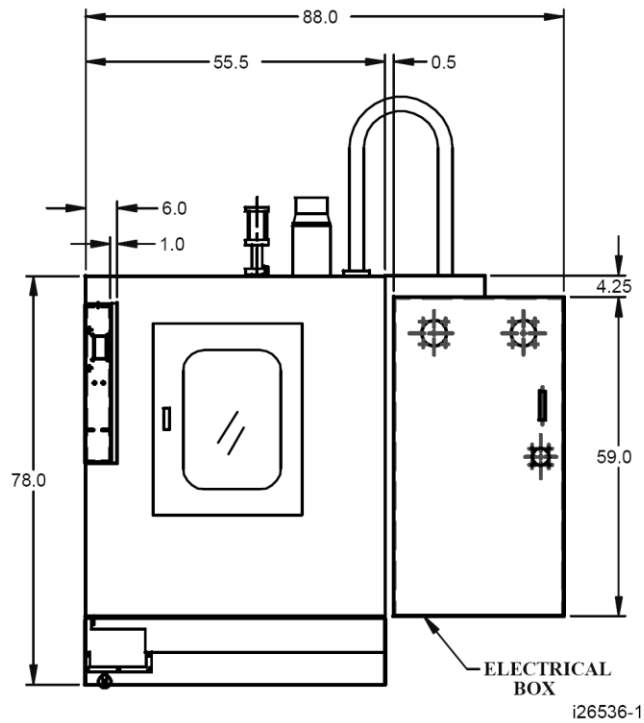
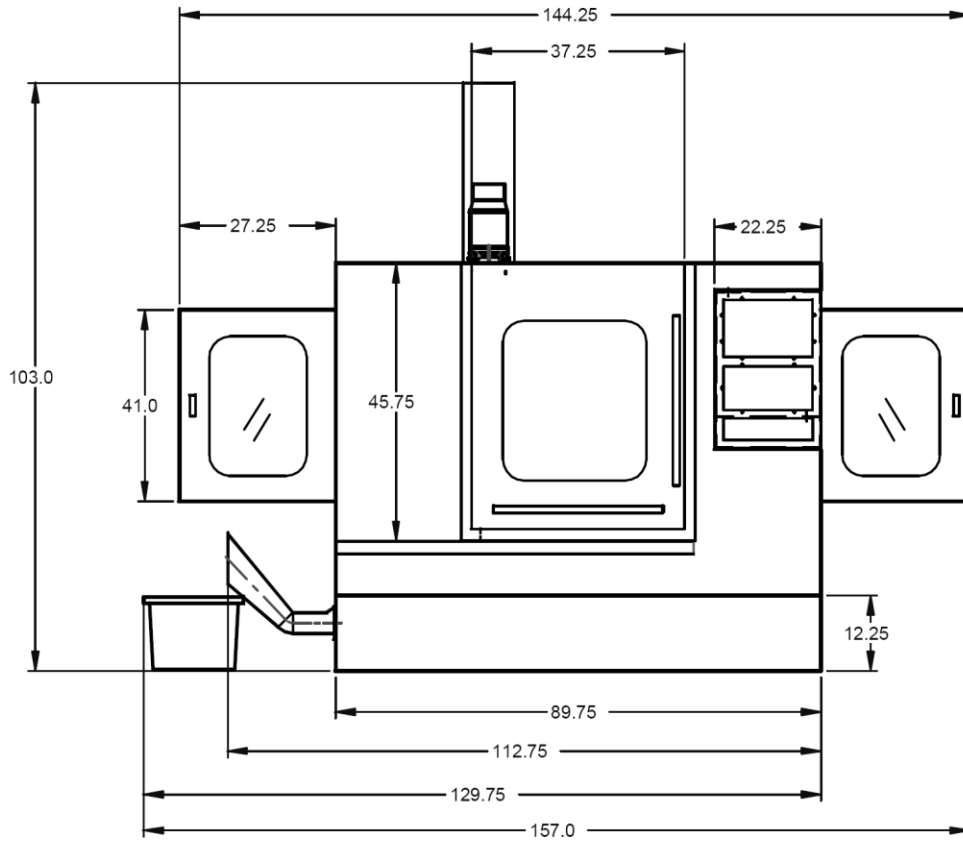

i26536-1

3.3.1 Overall Machine Dimensions

Width of LPM without chip cart and auger chute	89.75"
Depth of LPM	88"
Height of LPM with head all the way up	103"
Width of LPM with chip cart and side doors open	157"
Minimum height to fit LPM through doorway (Z cable carrier collapsed)	85"
Machine weight	7650 lbs.

3.3.2 Machine Specifications

Table Dimensions	
Table size	35.38" X 19.63"
Number of tee slots and pitch	5 @ 100 mm
Tee slot width	0.710" or 18 mm
Table maximum load	1000 lbs.
Ball Lock ® hold down force torque	2250 lbs @ 35 in/lbs of torque
Travel	
X-axis	31"
Y-axis	18.5"
Z-axis	21"
Maximum distance from spindle nose table surface	24"
Minimum distance from spindle nose table surface	3.375"
Maximum swing clearance from spindle center to column	19.25"
Maximum Rapid speed X-axis, inches per minute	800
Maximum Rapid speed Y-axis, inches per minute	800
Maximum Rapid speed Z-axis, inches per minute	700
Spindle	
Tool holder type	CAT40
Spindle nose diameter	2.75
Maximum RPM	8000
Automatic Tool Changer	
Tool Capacity	16
Maximum tool weight including holder	15 lbs
Maximum tool diameter	3.14
Carousel speed	.8 sec from station to station
Tool selection system	Bi-directional/ shortest path
Retention knob	See section 3.3.11
Air Requirements	
Pressure	90 psi
Quality	Air dried/ water separator upstream of the LPM

3.3.3 Maximum Spindle Torque and Horsepower

The following graphs illustrate the continuous and peak torque vs. RPM and horsepower vs. RPM for the LPM machine at the spindle. Peak torque and horsepower values can only be attained for a short period of time before the spindle drive will fault out to protect the motor.

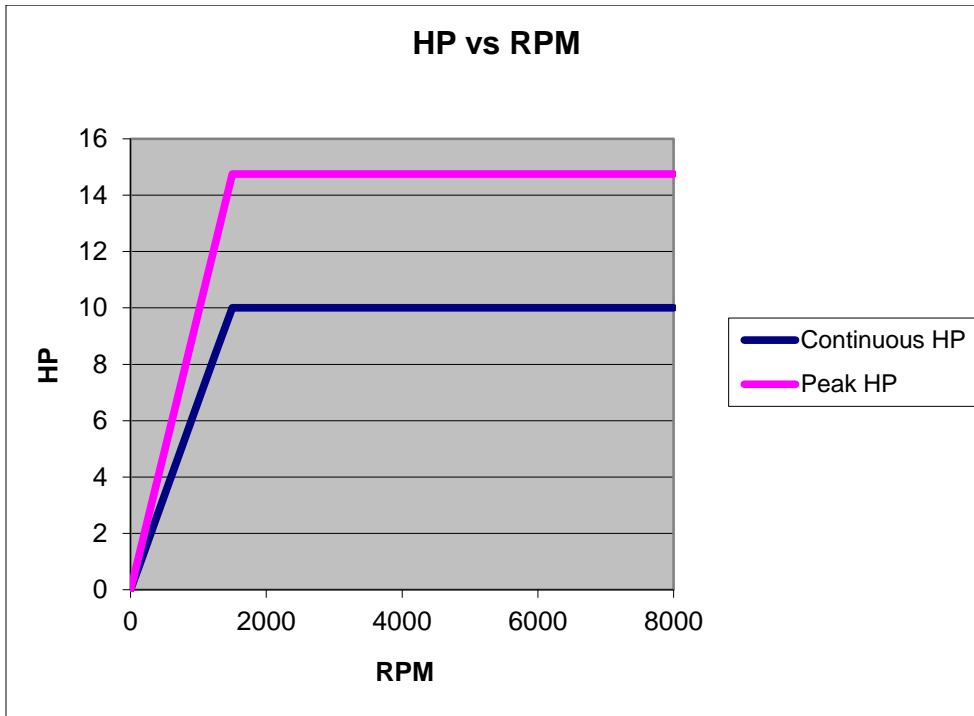
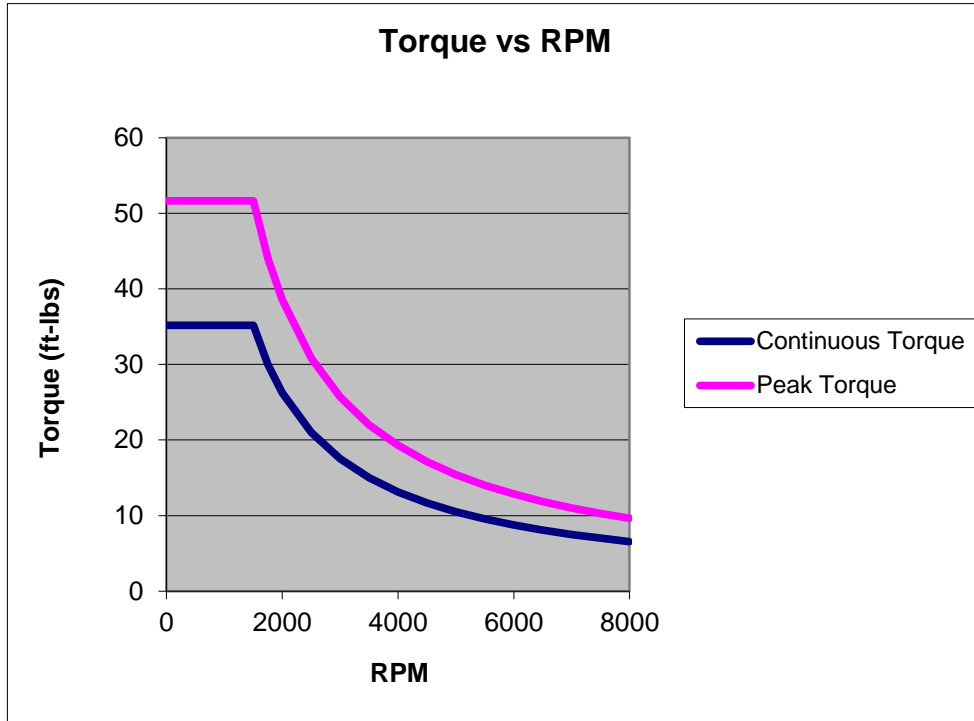

Note - Maximum work capacities are dependent on a lot of variables that cannot be controlled by the machine manufacturer. Each one of the following will have an impact on the above numbers: speeds, feeds, cutter, cutter sharpness, material, setup, coolant and machine adjustments.

3.3.4 Electrical Cabinet

The electrical cabinet is found at the rear of the LPM on the right side. The electrical cabinet contains the main control hardware for the machine. The main components are as follows: computer module, AC spindle drive, servo drives, input/output modules, relays and contactors.

3.3.5 Computer Module

The computer module is the heart and soul of the machine. All of the inputs and outputs are feed through this module. The computer module controls the program panel, run panel, AC spindle drive, servo drives, motor signals and feedback and input/output modules. Inside of the computer module is a motherboard, motion control board and an applications board along with a power supply.

The computer module also contains 4 more USB ports and a network port. We ship the machine with 3 USB ports having something plugged into them. The 3 USB ports contain the following: machine option key, a D drive for part storage and an overlay interface USB cable. The network port is available to the user if they want to network the control to an offline computer or network.

3.3.6 Servo Motors

The LPM can run up to 4 axis motors. The 4th motor would be used to control a 4th axis indexer. The motors used on the X and Y axis are rated for 4.2 ft/lbs of torque. The Z axis motor is rated at 8.11 ft/lbs and also contains a mechanical brake the holds the head in position when the power is turned off to the machine.

3.3.7 Servo Drives

The LPM can also contain up to 4 servo drives. The 4th amp would be used to control a 4th axis indexer or rotary table. The servo drives receive signals from the computer module, which in turn send signals to the servo motors.

3.3.8 Spindle

The spindle is contained within a cartridge and CAT 40 tool holders must be used. The spindle bearings are permanently lubricated and require no additional attention by the user. The spindle is also air cooled, and has an air purge system that is automatically activated during the tool change sequence, it blows air down the spindle to prevent chips from being trapped between the holder and spindle taper.

Warning!
The spindle unit is not field serviceable. If the bearings go bad the entire spindle cartridge will be replaced.

3.3.9 Spindle Motor & Drive

The spindle motor is 10 HP and drives the spindle via a timing belt. The ratio between the spindle and spindle motor is 1 to 1. The RPM range for this machine is 150 to 8000 RPM.

3.3.10 Automatic Draw Bar Assembly

The automatic drawbar is an assembly consisting of an air cylinder and an actuator that unclamps the tool. Tooling is changed by means of the Automatic Tool Changer (ATC), or can be done manually by pressing and holding the “Unclamp” button. Tools are clamped when the button is released. A clamping force of approximately 1500 lbs is generated to clamp the toolholder to the spindle. The Automatic Draw Bar Assembly uses full system air and requires no adjustment. The air cylinder that does the clamping and unclamping is lubricated with a small cup. Make sure to check the oil level in this cup on a regular basis.

3.3.11 Retention Knobs

The LPM uses CAT40 retention knobs as shown below. Tightening to the proper torque value is important for all retention knobs. Please see the retention knob manufacturer for the proper torque.

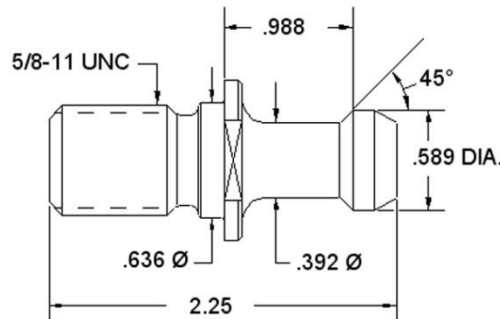

Retention knobs

Warning!

Retention knobs come in a wide variety of designs, however they often look similar and appear to be interchangeable, but they are not. Use only the knob that the LPM is designed to use. The use of the incorrect knob, or the incorrect use of a knob, may result in injury and/or damage to the mechanism.

3.3.12 Tool Changer

The tool changer is an armless carousel type automatic tool changer that has a capacity of 16 tools. The carousel is mechanically indexed by means of a Geneva mechanism. The position of the carousel is controlled by a signal from Home Position Sensor. As an additional safety feature, the ATC also has Tool Detect Sensor at the “ready position”. This means if a tool is sitting in this position and the control tries to put the tool in the spindle into this spot, an error will be generated by the control.

3.3.13 Drive Train, Axes

Each axis (X, Y and Z) rides on precision linear guideways, with four preloaded recirculating ball carriages. Each axis is moved via an 8 mm pitch ballscrew. The axis motors direct drive the ballscrew.

3.3.14 Worktable

The LPM table utilizes Ball Lock® technology as well as conventional T-bolt construction. Each Ball Lock mechanism has a hold-down force of 2250 lbs when 35 in/lbs of torque is applied to the screw. The software on the LPM is based on these ball locks as we ask the user which ball lock location they wish to run the part on. The 3 locations are called ball lock A, B and C.

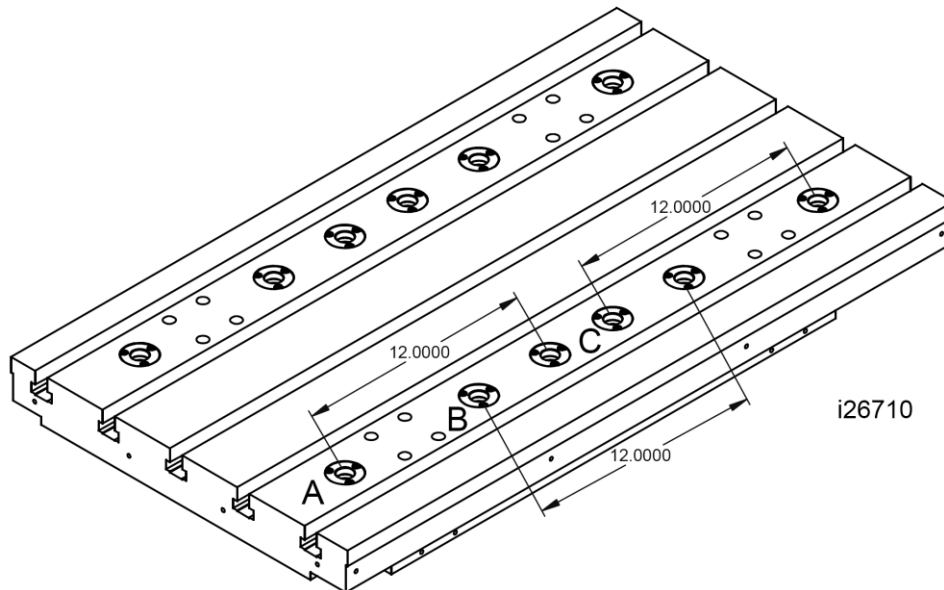

3.3.15 Limit/Home Switches

Each axis has a limit switch, which serve two purposes, to protect the LPM in the event of an over-travel situation in either the positive or negative direction, and secondly for the purpose of homing the machine. The following table describes where the cams are that trigger the limit switches.

Limit Switch Cam Locations

Axis End	Location of Cam Bracket	Cam Location
X-axis Negative End	Left hand side of the table (front)	Upper channel
X-axis Positive End	Right hand side of the table (front)	Lower channel
Y-axis Negative End	On the base casting, beneath the saddle (back)	Upper channel
Y-axis Positive End	On the base casting, beneath the saddle (front)	Lower channel
Z-axis Negative End	On the column casting (upper)	Right hand channel
Z-axis Positive End	On the column casting (lower)	Left hand channel
ATC Home Position Sensor	ATC shroud	Target bolt on the carousel
ATC Sliding Body, home	Bracket-Sliding Body Support, left	Sliding Body
ATC Sliding Body, Advanced	Bracket-Sliding Body Support, right	Sliding Body

WARNING!

It is not recommended that the position of the limit switches be changed. They are preset at the factory and should require no additional adjustments. Should any major adjustments be required, Service Codes 500, 501, 502 and 505 may need to be performed.

3.3.16 Lubrication System

The automatic lubricating system is a centralized system. It is located at the rear of the machine. While the system is automatic, it is recommended that after long idle periods, the machine be manually lubricated by pressing, holding (about five seconds) until the system is charged, then releasing the square green button located on the lubricator, repeat three to five times. The lubricating system delivers 2 shots of oil when the machine is turned on at the disconnect switch, and 1 shot every 30 minutes while the machine is running. The lubrication reservoir should be maintained on a daily basis, filling only with high quality lubricating oil. All pneumatic components are lubricated by means of an inline oiler.

3.3.17 Coolant and Coolant Wash System

The coolant and coolant wash system uses two pumps, one for providing coolant to the work, and the other for washing the chips into the auger. Wash areas can be controlled by the flexible coolant lines found at the base of the enclosure, both left and right-hand sides. Coolant wash can also be done with the use of the hose and nozzle found on the front exterior of the enclosure. The coolant feature must be turned on at the hard key on the Run Panel.

The coolant tank holds approximately 55 gallons of coolant.

3.3.18 Pneumatic System

The machine requires a supply of compressed air between 85-100 psi with a recommended air supply of ½" I.D. Air pressure to pneumatic components, the ATC slide mechanism, air blast and air purge (internal spindle) can be controlled individually by means of the adjusting valves located at the back of the LPM.

CAUTION!
Always observe low air pressure and low oil level warnings.

3.3.19 Enclosure Doors

The front door has an electro-mechanical safety interlock that must be engaged when running a CNC program. If the door is opened during a machining operation, the program will be shut down.

Do not open the door during a tool change. If you do this accidentally, see section 12.1.7 for instructions on resetting the ATC.

The enclosure is also equipped with left and a right latched and lockable access doors.

CAUTION!
Do not attempt to disable or override the safety interlock.

3.3.20 Beacon Lights

The machine has a beacon light attached to the top of the machine to give the user status of what is going on. The lights perform as follows:

- a. The green light is illuminated when the machine is running a program.
- b. The yellow light is illuminated when operator input is required, like when a part change needs to be done.
- c. The red light is illuminated when an alarm has occurred.

3.3.21 Chip Removal System

The LPM uses an auger chip removal system. When the forward direction is chosen on the run panel, the auger will displace chips into the chip cart. It can be run momentarily in the reverse direction in order to free a jam.

WARNING!
Use extreme care when working with the auger, serious injury could occur.

3.3.22 Work Lamps

The LPM comes equipped with two fluorescent work lamps, which come on automatically when the power is turned on.

4.0 Basic Operation

This section covers the basic operation of the machine and control issues that apply to more than one Mode or are not covered in the sections on the individual Modes.

4.1 Machine and Control Power On

To turn the ProtoTRAK PMX CNC on, turn on the main breaker on the rear control cabinet.

The Windows operating system and the ProtoTRAK PMX CNC software will take a few seconds to load from the system's flash memory. If you have connected the ProtoTRAK SMX CNC to a network, it may take as long as 90 seconds for the communications to be established. When complete, the ProtoTRAK PMX CNC Select Mode screen will appear.

4.2 Control and Power Off

IMPORTANT: the system must be turned off properly. First press the BACK hard key until the SHUT DOWN soft key appears on the menu. Press the SHUT DOWN soft key and a warning message will appear:

“Warning ProtoTRAK shutdown”

Press YES if you wish shut down the ProtoTRAK. The Microsoft Windows screen will be displayed with the message “Windows is shutting down”. Do not turn off the Main Breaker on the rear control cabinet until the screen goes black. If the CNC is not shut down properly you may lose unsaved data such as programs or certain machine configurations.

Note: When you turn the PROTOTRAK PMX CNC off, always wait a few seconds before turning it back on.

4.2.1 Energizing The Servos

Power On turns on the Main system software, but not the X, Y, and Z servo motors. To do this press the green SERVO ON button which is located on the right side of the pendant. If this is not done and an attempt is made to move the machine an E-Stop error message will appear. Pressing the SERVO ON button will erase this message.

Caution!

If the LPM has been sitting idle for long periods of time with the power on, then you should manually lubricate the machine. See section 3.3.16 for instructions.

4.2.2 Homing The Machine

Press the HOME SET soft key to send the machine to the Machine Home Position. The Z axis will retract to tool change position and the carousel will rotate to position no. 1. Then the X and Y axis will rapid to machine home. The machine may be operated in a manual mode, but running a program without Homing the machine is prohibited. An error

message “Machine has not been homed” will appear and can be cleared by performing the Homing operation.

4.2.3 Warming Up The Machine

A proper warmup cycle is necessary to extend the life of the machine as well as maintaining repeatability. Putting a cold spindle under load can produce premature bearing failure. Warming up the spindle allows bearings, supports and shaft to reach their designed dimensions through thermal expansion. Warming up the machine axis by moving through its entire machine envelope ensures that lubrication reaches all areas of the working envelope and helps to eliminate premature wear. In addition, thermal expansion of the axis must be taken into consideration. At the beginning of machine operation, thermal expansion is not stabilized and workpieces machined during this period may not be finished accurately.

Once the machine is Homed you will be asked whether you want the machine to perform a warm-up exercise program of 10 or 20 minutes. A dialogue box will appear if the YES soft key is pressed. Follow the instructions that are listed on the screen.

Note: The Z axis must be set to a minimum height so the machine will clear any part or fixturing.

The X and Y axis will move through a stroke of 17.0” and the Z axis will move from tool change position to the position established in the procedure above. All three axis move at 150.00 inches per minute individually. The spindle will run at 500 rpm and a countdown clock is displayed to show how much time is left in the cycle. When the cycle is completed all operations may be performed on the machine.

4.2.4 Current And Staged Control Views

CURRENT MODE enables you to perform all manual and Run Mode operations and view all the screens that pertain to these operations. In CURRENT MODE you can run a part, use the Pulse generator to move the machine, load and unload tools, including many other operations. In this mode the lettering in the soft key menu at the bottom of the screen is black with a grey background.

STAGED MODE is a ProtoTRAK software feature that drastically reduces setup time for the next part that is scheduled to run. While the machine is CURRENTLY running production, the operator can write, edit, input or output programs, enter tool and fixture offsets, and tool path can be verified. In STAGED MODE the lettering is blue with a white background. Following is a list of modes the operator can use in STAGED MODE that will not affect the CURRENT MODE of operation.

- a. PROGRAMMING
- b. PROGRAM SETUP
- c. MACHINE SETUP(Checklist Only)
- d. PROGRAM IN/OUT
- e. EDIT

Operations that cannot be performed are:

- a. DRO Mode
- b. Tool load and unload
- c. RUN

4.3 Spindle Operation

The three buttons on the front control, FORWARD, STOP, REVERSE, will operate the spindle in DRO, Part Fixture Mgmt., and Run mode.

4.4 Electronic Handwheel

4.4.1 Manual Axis Movement

In DRO mode all axis can be moved by the Electronic Handwheel on the front control panel. The center EHW button turns on the Hand Wheel and the operator can then choose which axis to move. Inch or metric increments can be chosen by pressing the inch/mm button on the front control panel in increments of .0001"/.002 mm, .0010"/.025mm, .0100"/.25mm, and .1000"/2.54mm.

4.4.2 Feed Override

Feed override is located below the Electronic Handwheel. When this button is pressed the operator can adjust the rapid rate and feed rate of the machine in 2% increments by rotating the Electronic Hand Wheel clockwise or counterclockwise.

4.4.3 Spindle Override

Spindle override is located above the Electronic Handwheel. When this button is pressed the operator can adjust the spindle rpm's in 2% increments by rotating the Electronic Hand Wheel clockwise or counterclockwise.

4.5 Multiple Uses Of The GO Button

- a: Running a program.
- b: Loading and unloading tools to and from the carousel
- c: Positioning the machine in GO TO mode
- d: Using the Power Feed mode

4.6 Multiple Uses Of The STOP Button

- a: Stops axis movement when running a program
- b: Stops axis movement in GO TO mode
- c: Stops axis movement in Power Feed mode
- d: Stops a tool change operation. This should only be done if the operator perceives there to be a problem in the sequence (eg: calling a tool from the carousel with a tool still in the spindle). Refer to Section 4.4 of the service manual to resume tool change operations.

This does not exit the user out of a program that is running. Pressing GO will resume operation

4.7 Emergency Stop

Press the button to shut off power to the spindle motor and axis motors. Rotate the switch to release.

4.8 Enclosure

The LPM is fully enclosed enabling flood coolant and/or air blow aiding in efficient machining of any workpiece. Three access doors permit easy chip removal and fixture placement.

4.8.1 Front Door

The door is automatically locked during tool change operations. During RUN mode the door can be opened. This will stop the spindle and all axis motion. Coolant and air blow will be shut off. Operation can resume by closing the door and pressing GO. The DOOR LOCK/UNLOCK hard key can be used to prevent the door from being opened during RUN mode. When a program is finished running, the door will automatically unlock permitting the operator to gain access to the inside of the machine. If the operator resumes production (ig: pressing GO), the door will automatically lock until the cycle is complete.

4.8.2 Side Doors

There are access doors located on both sides of the machine. Pressing the lower button on the door latch releases the handle. Rotate the handle to open the door. When closing the door simply push the handle in to close.

4.8.3 Positioning The Control Panel

A lock pin is located above the control panel. The panel can swivel in and out when the pin is pulled out and locked at 45 and 80 degrees when the pin is pushed in.

4.9 Coolant

Oil or water soluble coolant is recommended for the machine. The coolant tank is self contained and may be rolled out from under the machine for cleaning and machine maintenance.

4.9.1 Coolant ON/OFF

The coolant ON//OFF button is located on the front control panel. Press the button for 1 sec. for manual coolant on and off. The coolant can also be turned on and off in auto mode by holding the button for approximately 3 seconds. (ie: program auxiliary events).

4.9.2 Coolant Wash

The coolant wash button is located on the front control panel. When turned on coolant flows through the base of the machine flushing chips into the auger.

4.9.3 Coolant Hose

A coolant hose is supplied to aid in cleaning the machine of chips. The coolant pump must be turned on to use this hose. To increase the pressure through the hose, turn off the coolant valves located below the spindle.

4.9.4 Checking Coolant Levels

The coolant level should be higher than the baffles located near the coolant pumps and can be checked visually.

4.10 Air

A single air line is required and located at the rear of the machine. A shut-off valve is supplied below the main pressure gauge.

4.10.1 Air Hose

A hand air hose is located to the right of the front door and may be used anytime during operation.

4.10.2 Air Blast

Two air lines are located below the spindle and can be turned on and off by a button on the front control panel or by the program using an auxiliary event.

4.10.3 Checking Air Pressure

Two pressure gauges are located at the rear of the machine. One regulates the main incoming pressure to the machine, the second regulates how much air runs through the spindle bearing assembly keeping out contamination.

4.11 Chip Removal

Chips can be removed with the auger located in the lower front base of the machine. Chips will exit through the chip spout located on the left side of the machine.

4.11.1 Auger Operation

The auger button is located on the front control panel and can rotate the auger forward or reverse. To run the auger in reverse you need to hold the reverse button down. Reverse would only be used in cases where the auger screw gets jammed. This might help free it up.

If the auger gets jammed and the reverse feature does not free it up, then you should press the E-stop and pull the coolant tank out towards the front of the machine so you will be able to see where the auger is jammed. Free up the jammed material and then push the tank back in place. Do not place your hand down in the chute when it is running or power is on trying to free the jam. Never remove the chute when power is on.

We recommend the auger be run continuously when the parts you are cutting produce a lot of chips. Failure to do so may cause chips to overflow into the coolant tank.

4.12 ATC Operation

4.12.1 Advancing The Carousel

The tool carousel button is located on the front control panel and can rotate the carousel clockwise or counterclockwise. The door must be closed in order for the carousel to rotate.

4.12.2 Manual Tool Load and Unload

The green button located on the front of the spindle headstock is the clamp and unclamp button. Manually loading and unloading tools can only be done with the door open.

4.13 Lubrication

The lubrication reservoir is located at the rear of the machine. The unit cycles automatically when the control is on. A button is located on the front of the unit and when pressed will pressurize the lubrication system. The pressure gauge will register a value and the button **should be released**. Only when the button is released does oil get supplied to all parts of the machine.

4.14 Help Functions

When a blue question mark appears next to the HELP hard key, that means special functions or configuration settings are available for the current operation. For example, at the program header with the highlight on the program name, the blue question mark appears. Pressing the HELP key at that time will call up a table with alpha and special characters you can use to name your program.

4.14.1 Math Helps

When the blue question mark does not appear, pressing HELP will initiate the Math Helps.

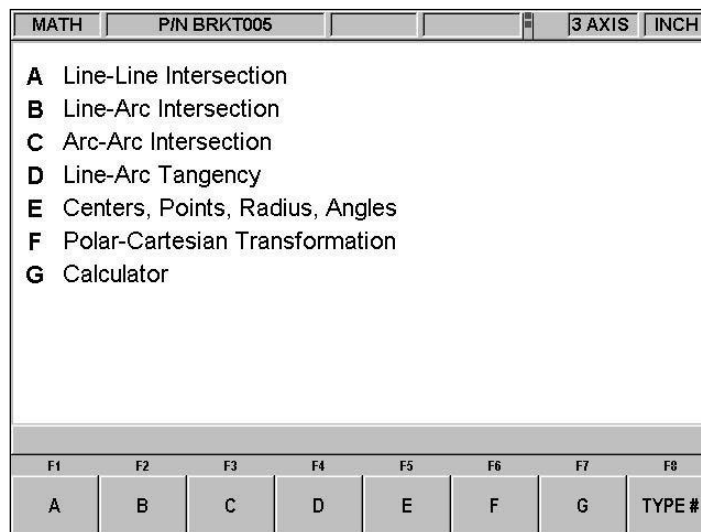

The first Math Helps screen. Choose among the alternatives based on the information you need to calculate.

Math Helps are powerful routines that enable you to use the data you have available to calculate missing print data.

For example, Math Help type 28 enables you to solve an entire right triangle by giving two known pieces of data. To exit from the Math Help, press the Mode key.

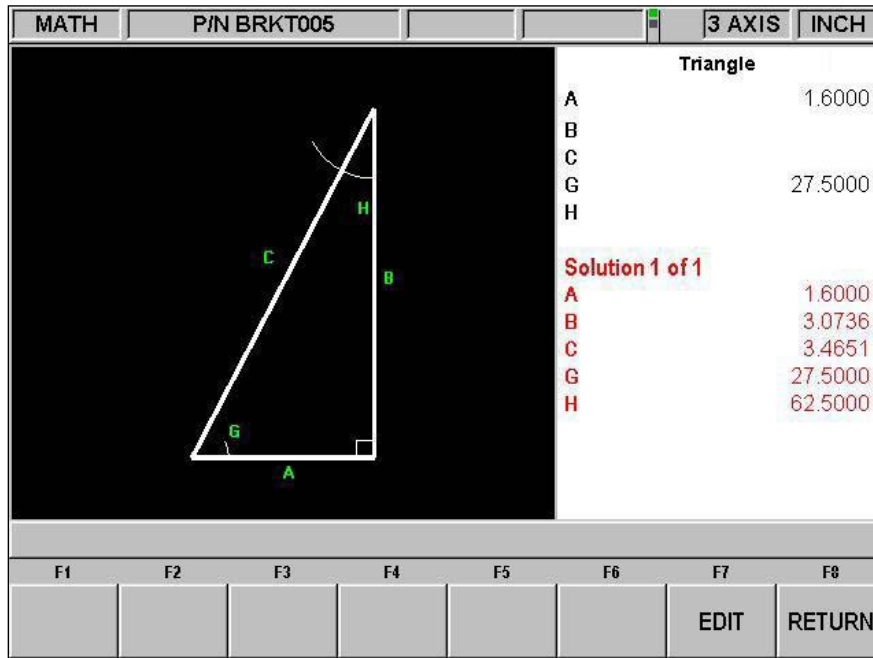

Math Help 28 In this example, by entering the length of line A and the value of angle G, the other values are calculated

You may have the Math Help solutions load directly into your program. This saves you from having to write down the solution and then key it in. While you are programming the event that needs the data from Math Help, simply press the HELP key to start the Math Help. Once a solution is obtained, you will have the following soft key selections:

LOAD BEGIN: will load the displayed solution into the event as the X and Y beginning.

LOAD END: will load the displayed solution into the event as the X and Y end.

LOAD CENTER: will load the displayed solution into the event as the X and Y center.

NEXT SOLUTION: when there is more than one solution to the problem, this will display the alternative solutions.

EDIT: this allows you to go back to the data you entered in order to make changes. Once you do this, the Resolve key will appear.

RESOLVE: press this to have the Math Help use the new data to give new solutions.

5.0 Definitions, Terms & Concepts

5.1 ProtoTRAK PMX CNC Axis Conventions

Hint: It is much easier to program if you imagine the tool is moving and think of the tool movement rather than focus on the machine table and saddle movement.

X Axis: positive X-axis motion is defined as the table moving to the left when facing the mill. Consequently, measurement to the right is positive on the workpiece.

Y Axis: positive Y-axis motion is defined as the table moving toward you. Measurement toward the machine (away from you) is positive on the workpiece.

Z Axis: positive Z-axis motion is defined as moving the head up. Measurement up is also positive on the workpiece.

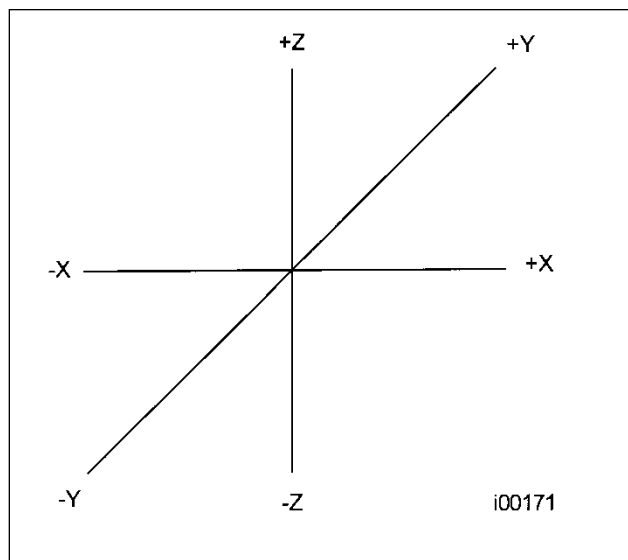

ProtoTRAK PMX CNC conventions in terms of tool movement.

The Z RAPID dimension is the position at which Z will stop rapid traversing and switch to its programmed Z feedrate. Z motion will continue until Z End depth has been reached.

5.2 Part Geometry and Tool Path Programming

The ProtoTRAK PMX CNC gives you ultimate flexibility in programming. Programs that are entered through the ProtoTRAK PMX CNC system can be entered as either Part Geometry or Tool Path.

Part Geometry programming is the popular programming style of the ProtoTRAK family of products. This is done by defining the final geometry of the part, and the ProtoTRAK PMX CNC has the job of figuring out the tool path from the part dimensions and the tool set-up information. This is a great benefit compared to regular CNC because it doesn't force the programmer to do the difficult job of defining tool path. A consequence of part geometry programming is that the following are not allowed:

- Connection of an incline plane and another event
- Connection of two events that lie in different planes

Using Geometry Programming, it is impossible for the ProtoTRAK PMX CNC to calculate a tool path for these cases without creating a problem: in cutting the geometry desired in the first event, the tool ends up out of position for the next event. Resolving the difference in tool position where the first event ends and the next event begins means either the CNC calculates and makes an unprogrammed move, or it retracts the tool out and then back into the part.

These cases are not encountered often, but when they are you have the option of using Tool Path programming. In Tool Path programming you define the events the same way, but all inputs are treated as tool center. It is your job to calculate and program the tool path.

Programs generated by CAD/CAM systems are always generated as Tool Path programs.

5.3 Planes and Vertical Planes

A plane is any flat surface. If that surface lies flat on the table, it is the XY plane. That is, if you move your finger along that surface or plane, you are moving in the X and/or Y direction, but not in Z (or at least not until you pick your finger up). If you tilted that surface (think of it as a piece of paper) straight up so that it faces the front of the machine, it would be in the XZ plane. If you tilted it up so that it faced left or right, it would be in the YZ plane.

A vertical plane is any plane (or surface) tipped up on its edge on the table (see below).

Unlike most CNC controls, the ProtoTRAK PMX CNC can machine arcs in any vertical plane rather than just XZ or YZ.

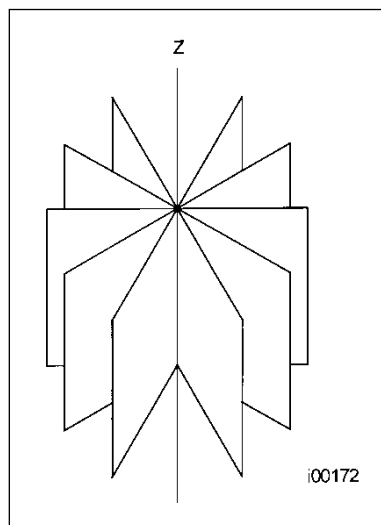

Vertical planes.

5.4 Absolute and Incremental Reference

The ProtoTRAK PMX CNC may be programmed and operated in either (or in a combination) of absolute or incremental dimensions. An absolute reference from which all absolute dimensions are measured (in DRO and program operation) can be set at any point on or even off the workpiece.

To help understand the difference between absolute and incremental position, consider the following example:

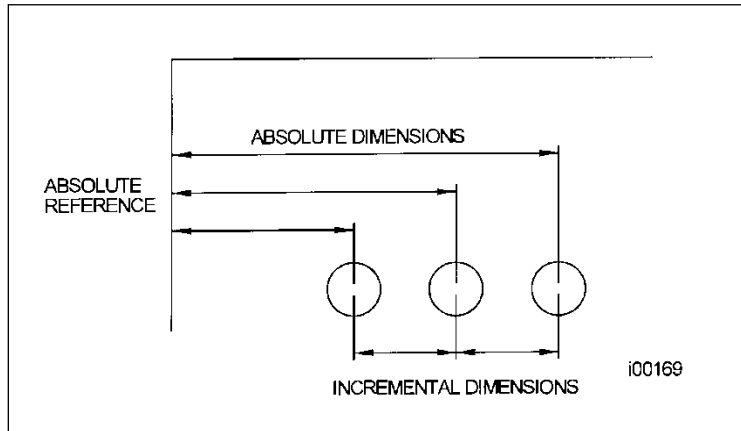

Each point has both an absolute and an incremental reference in the X-axis. The ProtoTRAK PMX CNC allows you to program using either.

5.5 Referenced and Non-Referenced Data

Data is always loaded into the ProtoTRAK PMX CNC by using the INC SET or ABS SET key. X, Y, Z positions are referenced data. In entering any X, Y, or Z position data, you must note whether it is an incremental or absolute dimension and enter it accordingly. All other information (non-referenced data), such as tool diameter, feedrate, etc. is not a position and may, therefore, be loaded with either the INC SET or ABS SET key. This manual uses the term SET when either INC SET or ABS SET may be used interchangeably.

5.6 Incremental Reference Position in Programming

When X, Y, Z RAPID and Z data for the beginning position of any event are input as incremental data, this increment must be measured from some known point in the previous event. Following are the positions for each event type from which the incremental moves are made in the subsequent event:

Position: X, Y and Z programmed

Drill: X, Y, Z RAPID, and Z END programmed

Bolt Hole: X CENTER, Y CENTER, Z RAPID and Z END programmed

Mill: X END, Y END, Z RAPID and Z END programmed

Arc: X END, Y END, Z RAPID and Z END programmed

Circle (POCKET or FRAME): X CENTER, Y CENTER, Z RAPID and Z END programmed

Rectangle or Irregular (POCKET or PROFILE): X1 and Y1 corner, Z RAPID and Z END programmed

Helix: The X END, Y END, Z RAPID, and Z END programmed.

Sub: The reference position as defined for the specific events above for the event prior to the first event that was repeated.

A.G.E. Profile: The appropriate reference position as defined for the specific events above for the last event that is programmed.

For example, if an ARC event followed a MILL event, a 2.0 inch incremental X BEG would mean that in the X direction the beginning of the ARC event is 2.0 inches from the end of the MILL event.

5.7 Tool Diameter Compensation

Tool diameter compensation allows the machined edges shown directly on the print to be programmed instead of the center of the tool. The ProtoTRAK PMX CNC then automatically compensates for the programmed geometry so that the desired results are obtained.

Tool cutter compensation is always specified as the tool either right or left of the workpiece while looking in the direction of the tool motion.

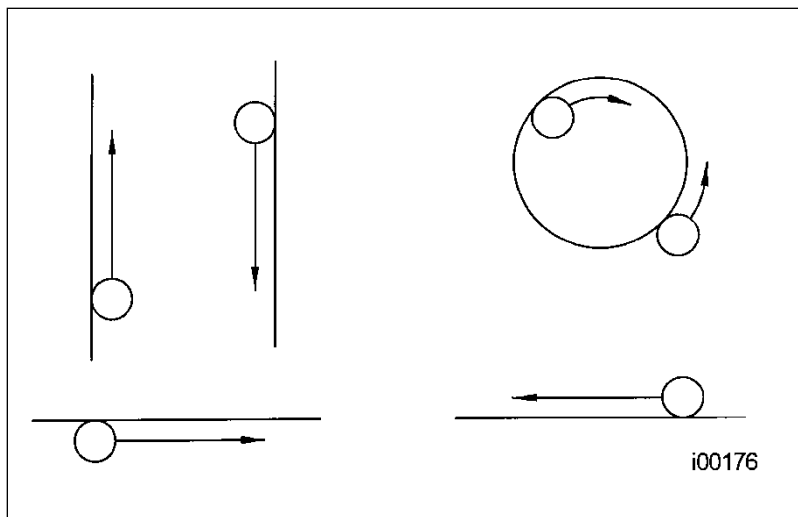

Examples of tool right.

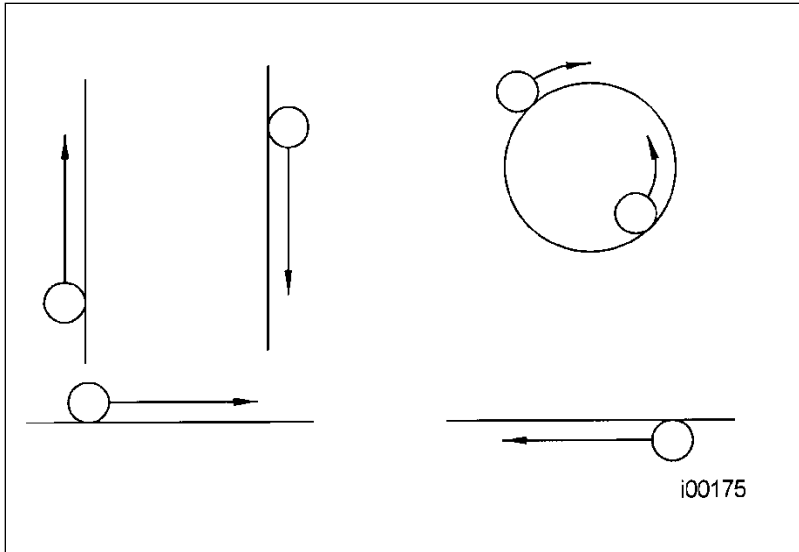

Examples of tool left.

Tool center means no compensation either right or left. That is, the centerline of the tool will be moved to the programmed points.

Hint: to determine tool left or right, imagine that you are sitting on the tool as it is moving.

5.8 Tool Diameter Compensation when Contouring in Z with Part Geometry

Left and right tool diameter offsets are always those projected into the XY plane. Tool offsets in the Z direction are always up and assume the use of a ball end mill. When contouring in the Z-axis, this up tool offset is always activated regardless of left, right, center if programming Part Geometry. There is no Z-axis up tool offset applied when programming Tool Path.

Special attention must always be paid to tool offsets when machining with a ball end mill. The reason for this is that the tool diameter changes in the bottom part (that portion equal to the tool radius) of the tool.

The tool is always positioned at the beginning of a milling operation so that the correct point on the ball end of the tool is tangent to the beginning point, and offset perpendicular to the machined edge by the radius of the tool. Consider the example below of milling a ramp in the XZ plane from point B to point C.

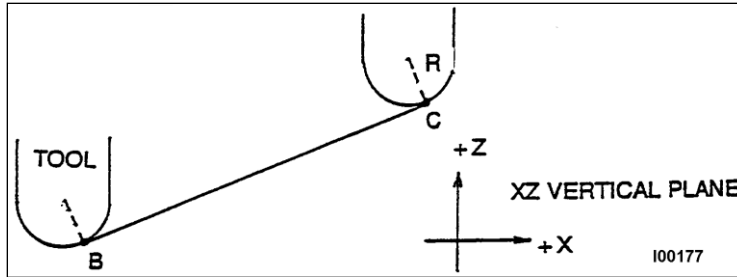

Ball end mill position with respect to program points. Tool starts so end mill is tangent to BC. R from center of tool is perpendicular to BC.

Note how the tool at the beginning point (point B) starts below (in the Z direction) point B so that it can actually touch this point. If this were not true, a cusp would remain to the left of point B.

Now consider a similar example milling from A to B to C in the XZ plane.

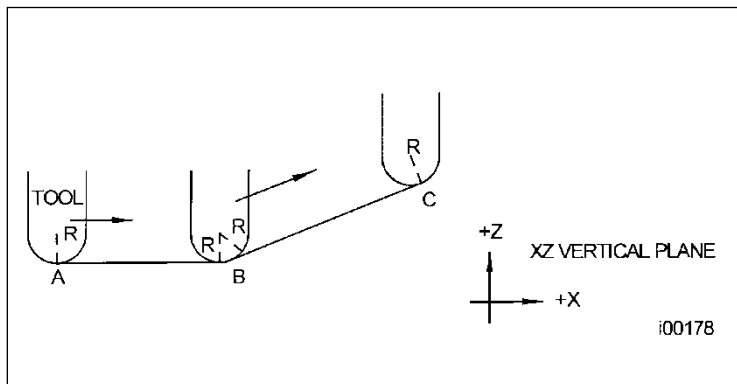

In order to respect the lines defined by the programmed points, the ball end mill never touches point B. Tool starts centered over A offset up by the tool radius R. It moves right until it is tangent to both AB and BC. Then moves to point C as in the first example

Note the Tool at B does not drop below the AB line and, therefore, never touches point B. As a result, a fillet is formed at point B equal to the tool radius.

This second example of continuous machining from one cut (AB) to another (BC) with full cutter compensation between requires the two cuts to be made with events which are connective (see Section 5.9 or 5.10 for a more complete discussion of this requirement).

5.9 Connective Events

Connective events occur between two milling events (either Mill or Arc) when the X, Y, and Z ending points of the first event are in the same location as the X, Y, and Z starting points of the next event. In addition, the tool offset and tool number of both events must be the same. And both events must lie in the XY plane or the same vertical plane (see Section 5.2).

5.10 Conrad

Conrad is a unique feature of the PROTOTRAK PMX CNC that allows you to program a tangentially connecting radius between connective events, or tangentially connecting radii for the corners of pockets and frames without the necessity of complex calculations.

For the figure below, you program an Arc event from $X1, Y1$ to $X2, Y2$ with tool offset left, and another Arc event from $X2, Y2$ to $X3, Y3$ also with tool offset left. During the programming of the first Arc event, the system will prompt for Conrad at which time you input the numerical value of the tangentially connecting radius $r=K3$. The system will calculate the tangent points $T1$ and $T2$ and direct the tool cutter to move continuously from $X1, Y1$ through $T1, r=K3, T2$ to $X3, Y3$.

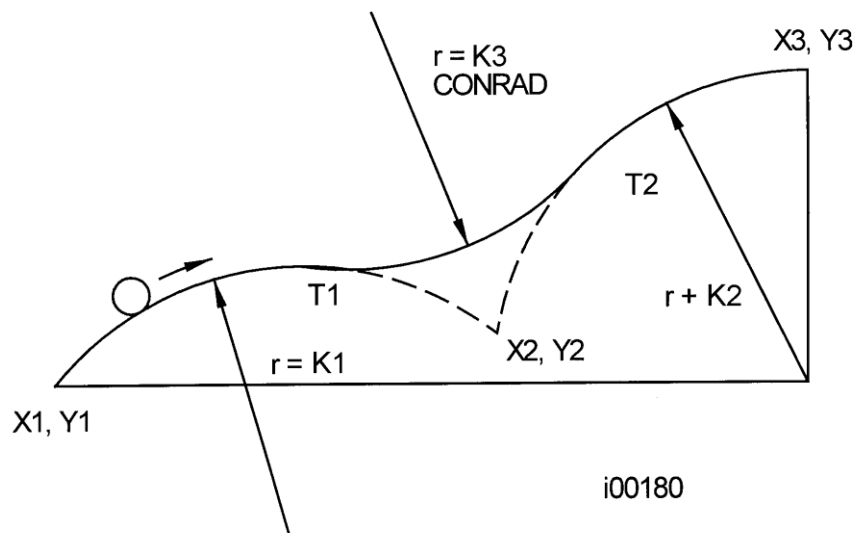
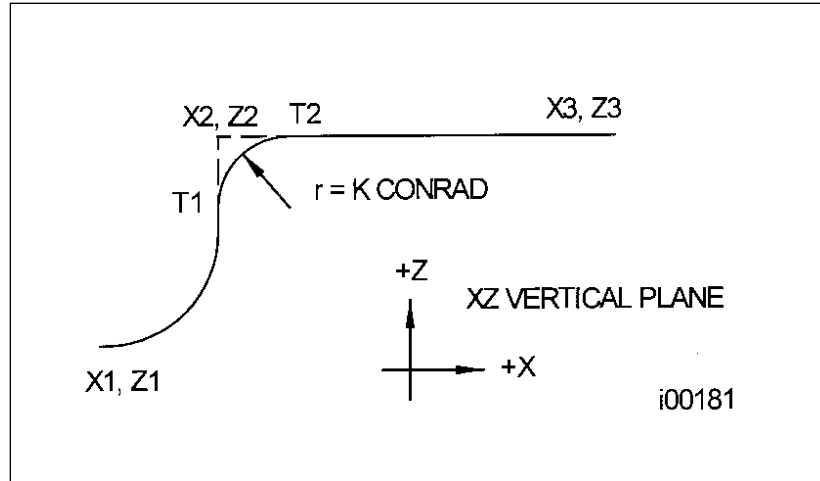

Figure 1

A Conrad is added between the two intersecting lines.

Note: Conrad must always be the same as or larger than the tool radius for inside corners. If Conrad is less than the tool radius, and an inside corner is machined, the ProtoTRAK PMX CNC will ignore the Conrad.

For the figure below, you program an Arc event from $X1, Z1$ to $X2, Z2$, and a Mill to $X3, Z3$. During the programming of the Arc event, the system will prompt for Conrad at which time you input the numerical value of the tangentially connecting radius $r=k$. The system will calculate the tangent points $T1$ and $T2$ and direct the tool cutter to move continuously from $X1, Z1$ through $T1, r=k, T2$ and on to $X3, Z3$.



A Conrad is added between an arc and a line.

5.11 Memory and Storage

Computers can hold information in two ways. Information can be in current memory or in storage. Current memory (also known as RAM) is where the ProtoTRAK PMX CNC holds the operating system and any part program that is ready to run. While a program is being written, it is in current memory.

For the ProtoTRAK PMX CNC, storage of programs is on a USB thumb drive or on a networked drive. We strongly recommend you habitually back up programs.

5.12 Current and Staged Views

Current refers to a program or operation that is being done at the present moment on the TRAK LPM. Staged refers to a program or operation that you intend to put on the machine in the future. The ProtoTRAK PMX allows you to toggle back and forth between these two states so that you can use labor better. Rather than have an operator stand and watch a (current) job running, he can use the staged view of ProtoTRAK PMX to do almost all the set up work for future jobs.

6.0 DRO Mode

The ProtoTRAK PMX provides a large display of the position of each axis in DRO Mode. This enables you to see the current position of your TRAK LPM and to make adjustments easily. With the Power Feed capability you are able to make some simple cuts easily. This screen in DRO mode typically is not used to establish part zero for production. Refer to section 6.2 for information on the multiple reference locations that are available to simplify machine setups.

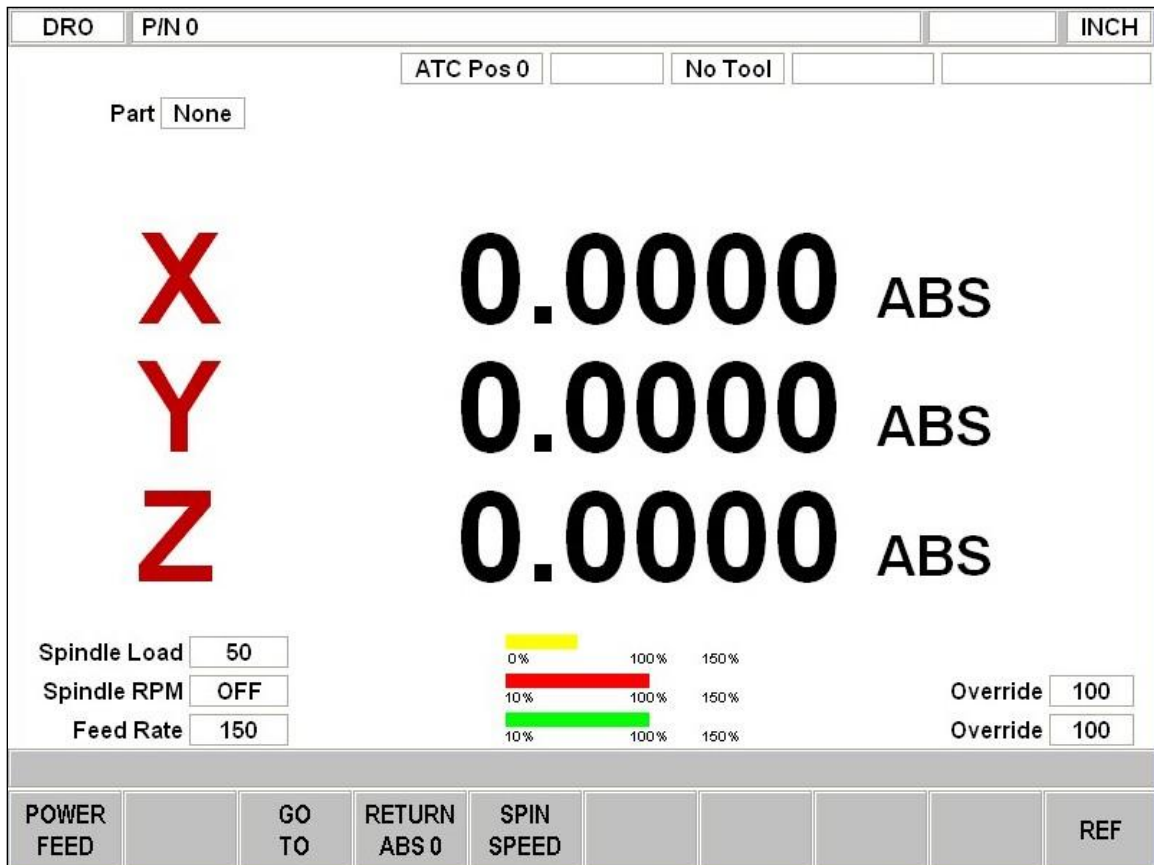

DRO Mode

6.1 Entering Dimensions

Inch to MM or MM to Inch: Press IN/MM and note LCD screen status line.

Reset One Axis: Press X or Y or Z, INC SET. This zeros the incremental position in the selected axis.

Preset: Press X or Y or Z, numeric data, INC SET to preset selected axis.

Reset Absolute Reference: Press X or Y or Z, ABS SET to set selected axis absolute to zero at the current position.

Note: This will also reset the incremental dimension if the absolute position is being displayed when it is reset.

Preset Absolute Reference: Press X or Y or Z, numeric data, ABS SET to set the selected axis absolute to a preset location for the current machine position.

Note: This will also reset the incremental dimension and add the value that was just input in the ABS screen, if the absolute position is being displayed when it is preset.
 Recall Absolute Position of All Axes: Press INC/ABS. Note the dimension for each axis is labeled INC or ABS. Press INC/ABS again to revert to the original reading.
 Recall Absolute Position of One Axis: Press X or Y or Z, INC/ABS. Note the INC or ABS label for each axis. Repeat to get selected axis back to original reading.

6.2 Reference Locations

The DRO Mode gives you the ability to manage your parts relative to several references. This integrates the workholding system with the ProtoTRAK PMX operation in a secure way that you can verify. That will give you the confidence to move swiftly through set-ups.

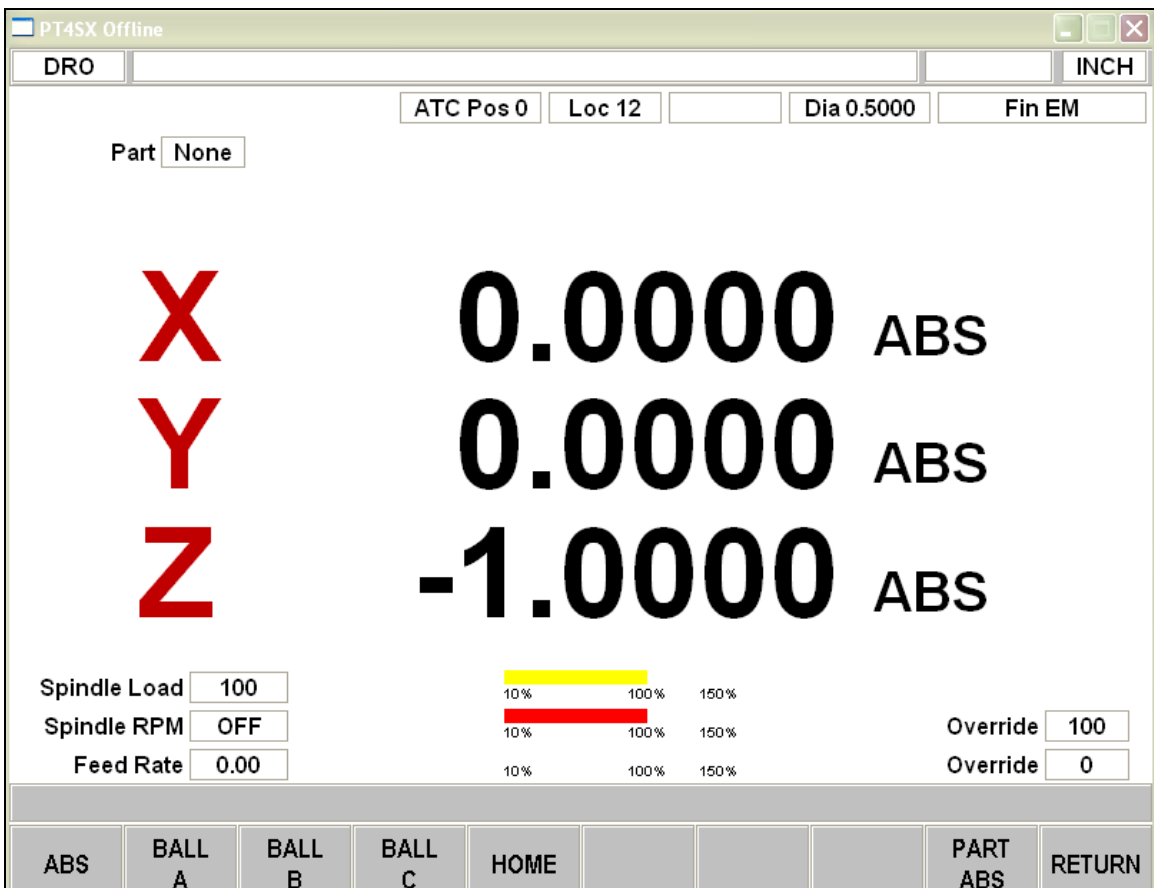

REF – Press this softkey to choose between the following reference locations:
 ABS – the current absolute 0 reference. This displays the distance the machine is from Part Zero.
 BALL A – This displays the distance the machine is from the center of Ball Lock A and the top of the table.
 BALL B – This displays the distance the machine is from the center of Ball Lock B and the top of the table.

BALL C – This displays the distance the machine is from the center of Ball Lock C and the top of the table.

HOME – This displays the distance the machine is from Machine Home and the top of the table.

PART ABS – after pressing this softkey you will be prompted to type in the part number. Type 0 for none, and parts 1 – 4 of the Master Program. If you do not have multiple parts in a Master Program, your part is Part 1. The numbers you see will be referenced from the absolute 0 of the part you choose. (If none is selected, there is no part Absolute 0 being referenced.) Your part's absolute zero is determined by your fixture offset. See section

6.3 Power Feed

The servo motors can be used as a power feed for the X, Y, and Z axis individually, or all three simultaneously.

- a. Press the POWER FEED soft key.
- b. A message box will appear that shows the power feed dimensions. All power feed moves are entered as incremental moves from the current position to the next position.
- c. Enter a position by pressing the axis key, the distance to go and the +/- key (if needed). Input the entry by pressing INC SET. For example, if you wanted to make a power feed move of 2.00" of the table in the negative direction, you would enter: X, 2, +/-, INC SET.
- d. Initiate the power feed move by pressing GO.
- e. The feedrate is automatically set to 10 ipm (or 254 mm per min). Press FEEDRATE OVERRIDE button to adjust the feedrate from 0 % to 150 % of the 10 inch per minute feedrate.

Note: In RUN mode feed override adjusts from 0% to 150% of the programmed feedrate.

- f. Press STOP to halt power feed. Press GO to resume.
- g. Repeat the process beginning at "c" above as often as you wish.
- h. Press RETURN soft key to return to manual DRO operation.

6.4 GO TO

When you press the GO TO Softkey, you will get the following choices:

BALL A – will position the center of the spindle over Ball Lock position A. The Z axis will move to the Tool Change height.

BALL B – will position the center of the spindle over Ball Lock position B. The Z axis will move to the Tool Change height.

BALL C – will position the center of the spindle over Ball Lock position C. The Z axis will move to the Tool Change height.

HOME – will position the center of the spindle over the machine Home location and the Z axis all the way up.

POSITION – allows you to set a dimension in reference to your current X, Y or Z Absolute position at which you want the machine to stop moving when you are moving an axis with the Electronic Handwheel.

6.5 Return to Absolute Zero

At any time during manual DRO operation you may automatically move the table to your absolute zero location in X and Y by pressing the RETURN ABS 0 soft key. When you do, the message window will read "Ready to Begin: Press Go when Ready". Make sure your tool is clear and press the GO key. The machine will move in rapid the Z axis to tool change position and then move the table to your X and Y absolute zero position. You will be at zero and in manual DRO operation. See Section 6.2, Reference Locations.

6.6 Spindle Operation

To set spindle speed press the SPIN SPEED softkey. The Data Input Line will prompt "Spindle RPM". Enter the RPM value (150-8000) and press SET. If the spindle was already on when you began to enter the new speed, it will stay at the current speed until you press the SET key.

You may override the spindle speeds with the SPINDLE OVERRIDE button above the handwheel. Press the SPINDLE OVERRIDE button. Use the Handwheel to change the spindle speed in 2% increments per pulse. Press the SPINDLE OVERRIDE button again to turn off the override feature.

6.7 Axis Motion In The DRO Mode

Whenever using the GO TO and ABS 0 function, keep the following in mind:

When you press a location for positioning the machine, the message window will read: "Ready to Begin: Press Go when Ready"

- a. Make sure your tool is clear of any fixturing or workpiece.
- b. The door must be closed before the machine will move.
- c. The Z axis will retract to the tool change position before moving in X and Y.

7.0 Program Mode Part 1: Getting Started & General Information

7.1 Programming Overview

The ProtoTRAK PMX CNC makes programming easy by allowing you to program the actual part geometry as defined by the print.

The basic strategy is to first fill in the initial program information in the Program Header screen and then program the features of the part by selecting the soft key event types (geometry) and then follow all instructions in the Data Input Line.

When an event is selected, all the prompts that need to be input will be shown on the right side of the screen. The first prompt will be highlighted and also shown in the Data Input Line. Input the dimension or data requested and press INC SET or ABS SET. For X or Y dimension data it is very important to properly select INC SET or ABS SET. For all other data either SET will do.

As data is being entered it will show in the Data Input Line. When SET, the data will be transferred to the list of prompts in the right side of the screen, and the next prompt will be shown in the Data Input Line.

When all data for an event has been entered, the entire event will be shifted to the left side of the screen and the conversation line will ask you to select the next event.

7.2 Enter Program Mode

Press MODE, select PROGRAM soft key.

The ProtoTRAK PMX CNC will allow one program in the Current view and one program in the Staged View. If there is already a program in the Current or Staged View, entering the Program mode will allow you to edit or add to that program.

PROG	P/N 0	INCH
Program Name	0	
Scale	1.000	
Dwell Request	NO	
Event Comments	NO	
Dimension Definition	PART GEOMETRY	
? Program Name : 0		
	GO TO BEGIN	GO TO END
		GO TO #

The Program Mode Header Screen

7.3 Program Header Screen

The first screen you see when you enter the Program Mode is the Program Header Screen. The Program Header Screen gives you options that apply to the entire program. The softkey selections allow you to enter the program at any point.

The program name and general programming options you choose in the Program Header Screen will be in the program as "Event 0".

7.3.1 Program Name

Programs written on the ProtoTRAK PMX CNC are usually named for the part that is to be machined. When programs (or files) are named using the ProtoTRAK PMX CNC, the name can be up to 25 characters long. Programs imported into the ProtoTRAK PMX CNC may be longer. While 25 characters are allowed, the entire program name may not be shown in the status line or the program header screen.

Program names can include numbers, letters, spaces and other characters.

Hint: do not use a period or / in program names. This will confuse the computer because it uses these characters to store and classify programs.

When the Program name prompt is highlighted, the Data Input Line will show "Program Name:"

At this point you may:

- Press number keys.
- Press Help to access alpha keys and special characters in the ProtoTRAK PMX CNC.
- Use a keyboard plugged into the ProtoTRAK PMX CNC to name the program.

Pressing the Help hard key when the Program Name is highlighted calls up alpha keys.

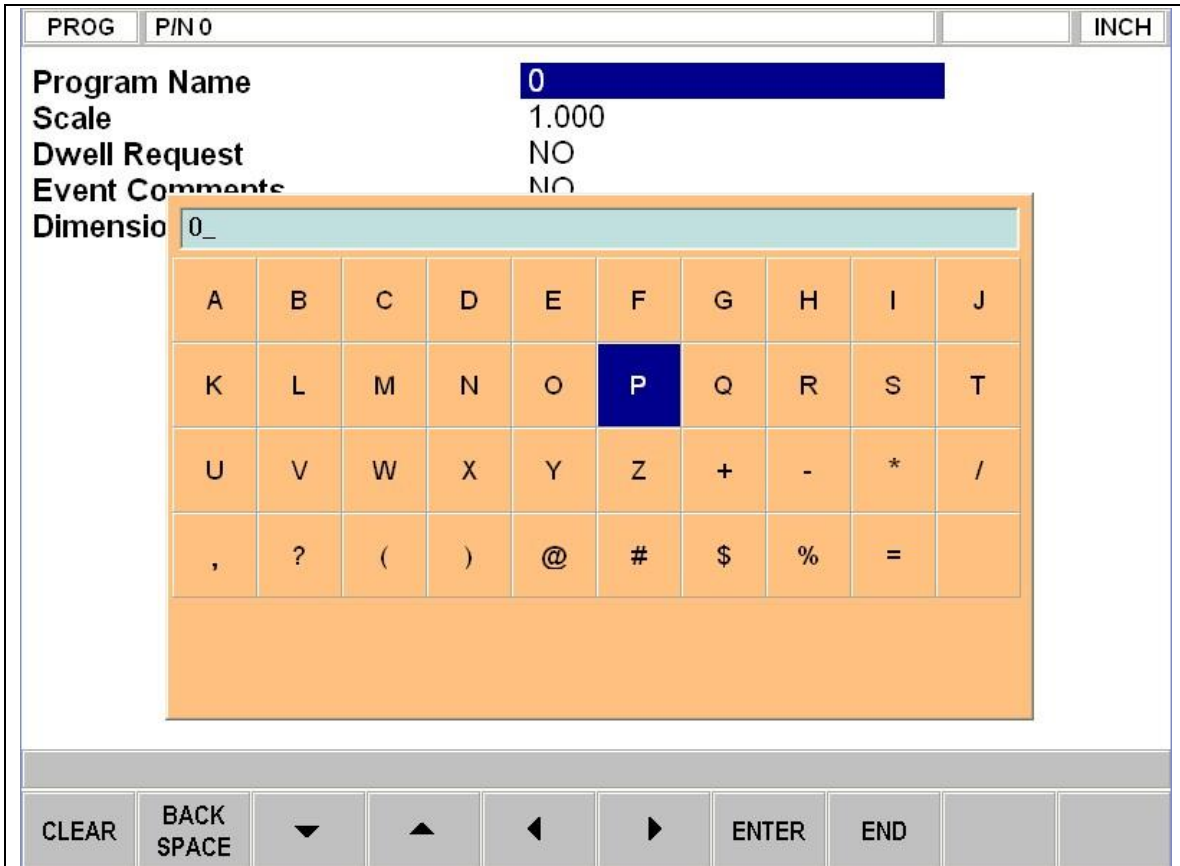

Program name input without a keyboard.

To use the alpha keys and special characters on the ProtoTRAK PMX CNC:

- Use the CLEAR softkey to erase the entire line; the BACKSPACE softkey to erase the last character or number.
- Use the arrow softkeys to move around the table.
- Once the character you want is highlighted, use the ENTER softkey to load the character into the program name.
- Use the blank space on the lower right of the table to insert a space into the program name.
- Once you finish entering the letters and special characters, press the END softkey. This tells the ProtoTRAK PMX CNC that you are finished with the alpha table. Numbers may still be added to the program name.

When you are finished with the program name, press SET to enter it into the current memory.

Note: It is not necessary to enter a part number. If none is entered and a GO TO soft key is pushed, the system will assume a part number 0.

7.3.2 General Program Options

Use the cursor keys to select general programming options.

Scale: Allows a scale factor between .1 and 10. An input of 5 means the part will be 5 times as big as the programmed dimensions. A value of 1.0000 is assumed if nothing is input.

Dwell Request: Allows you to input a dwell at the bottom of a drill bolt hole or bore cycle for events you select. Select the appropriate YES or NO soft key. If you select YES you will be prompted to input a dwell time in seconds from .1 to 99.9 when appropriate to the event being programmed.

Event Comments: If you select "Yes" for event comments, you will have the opportunity to insert a comment in each event. For Irregular Pocket and Irregular Profile events, you will be able to enter a comment at the header event, but not for each A.G.E. Mill and A.G.E. Arc event.

Comments appear in the Run Mode on the Data Input Line as the event begins to run. Comments may be composed of letters, numbers and some symbols and may be up to 20 characters.

While programming the event with the Event Comments set to Yes, when the highlight is on the Event Comments prompt, you may enter a comment using the same methods used to enter a program name, as described above.

Dimension Definition: The ProtoTRAK PMX CNC gives you a choice in programming either tool path or geometry. Part Geometry programming allows you to define the geometry you want your part to have and then the CNC does the difficult job of calculating tool path for you automatically. This is a great benefit for most parts most of the time because it means that the CNC is doing the hard work of determining tool position.

One restriction to part geometry programming is that for events to be connective, they must lay on the same plane (see Section 5.3 for a definition of planes). For this reason, the ProtoTRAK PMX CNC gives you the option of entering your own tool path. If you wish to program the part by defining tool path yourself, you may choose the TOOL PATH softkey. Otherwise, Part Geometry programming is assumed. Tool Path operates under the same rules as standard RS274.

A program must be entirely written in Part Geometry or Tool Path programming, you cannot combine the two methods in one program.

7.3.3 Program Header Softkeys

The following softkeys are encountered in the Program Header Screen. The first five listed below are always there. The last four appear when relevant to the general programming option.

GO TO BEGIN: puts the Program Header on the left side of the screen and the Event #1 on the right side.

GO TO END: puts the last programmed event on the left side of the screen and the next event to be programmed on the right side.

GO TO #: enter the event number you wish to go to and then press SET. Puts the requested event number on the right side of the screen and the previous event number on the left.

Note: for a new program that has no Events, all the GO TO selections will take you to the beginning, with the program header information summarized on the left (as Event 0) and the Select an Event options for Event 1 on the right.

YES and NO: YES and NO appear when the Dwell Request and the Event Comments are highlighted. Choosing YES will give you prompts for using these options while you are programming. You may return to the Program Header Screen at any time to choose or cancel these prompts.

NEXT PART: appears when a Master Program is in memory. Pressing this allows you to switch between the programs within the Master Program.

PART GEO: sets up the programming as Part Geometry.

TOOL PATH: sets up the programming as Tool Path.

7.4 Assumed Inputs

The ProtoTRAK PMX CNC will automatically program the following when you simply press SET (either INC SET or ABS SET):

Tool Offset: On the first event with an offset, it will become CENTER. If it is not the first event then it will enter the offset, which is the same as the last event if that event was a Mill or Arc event

Feedrate: same as last event if that event was a Mill, Arc, Pocket, Frame, or Helix

Tool #: same as last event, or Tool #1 if the first event

DRILL OR BORE: Drill

PECKS FOR DRILL: 1 peck

CONRAD: 0

You may change these assumed inputs by simply inputting the desired data when the event is programmed.

7.5 Z Rapid Positioning

Between any two events the head will always move to the higher of the Z rapid of the event just completed or the Z Rapid of the next event, unless the two events are connective (see Section 5.9). Remember, when using part geometry programming, two milling events are not connective unless they lie in the same plane.

7.6 Softkeys within Events

Once a geometry (Event) such as MILL or BOLT HOLE is selected, the softkeys will change.



Soft keys used while programming an event.

DATA BOTTOM: puts the Highlight on the last input.

INSERT EVENT: use this to insert a new event into the program. This new event will take the place of the one that was on the right side of the screen when you pressed the INSERT EVENT key. That previous event, and all the events that follow, increase their event number by one. For example, if you started with a program of four events, if you were to press the INSERT EVENT key while Event 3 was on the right side of the screen, the previous Event 3 would become Event 4 and the previous Event 4 would become Event 5. If you insert a Subroutine event, the event numbers will increase by one as when you insert another kind of event. If you insert a copy event, the event numbers will increase by the number of events that are copied.

DELETE EVENT: this will delete the event on the right side of the screen.

7.7 Programming Events

Once you press the appropriate GO TO soft key, you will begin to define your part as a series of Events. For the ProtoTRAK PMX CNC, an Event is a geometry, or a feature of a part.

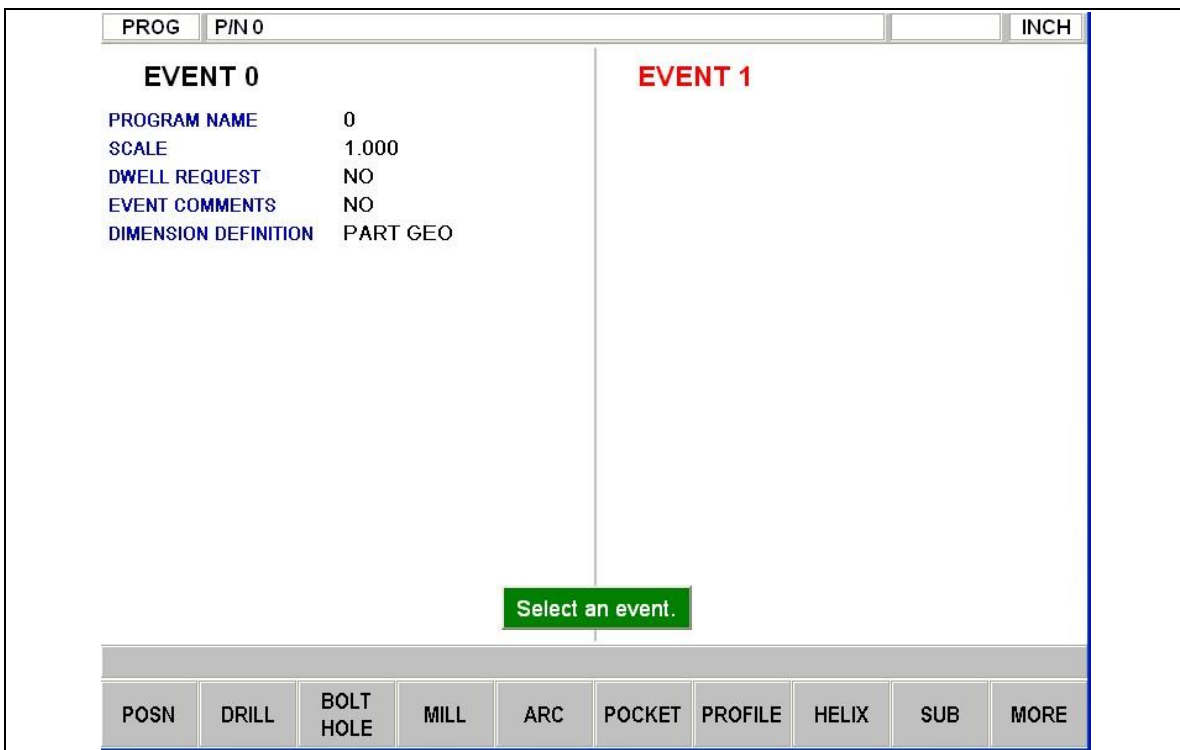

Program Begin.

In the figure above, the header screen has been completed and is on the left side. Select an event type from the soft keys

When the MORE softkey is selected, the soft keys change to:



After an event type is selected from the softkeys, the prompts for that event will appear on the right side of the screen. The data you need to enter to program the event will appear in the Data Input Line. As soon as you enter one piece of data by pressing the INC SET or ABS SET key, the next prompt will appear in the Data Input Line.

7.8 Editing Data While Programming

While programming an event, all data is entered by pressing the appropriate numeric keys and pressing INC SET or ABS SET. If you enter an incorrect number before you press INC SET or ABS SET you may clear the number by pressing RSTR (Restore). Then, input the correct number and press SET.

If incorrect data has been entered and SET, you may correct it you may correct it easily by pressing an arrow key until the incorrect prompt and data are highlighted and shown in the conversation line. Enter the correct number and SET. The ProtoTRAK PMX CNC will not allow you to skip past prompts (by pressing DATA FWD) which need to be entered to complete an event except when using the A.G.E. in the Irregular Pocket or Irregular Profile event.

Previous events may be edited by pressing the BACK hard key to the left of the soft keys. The previous event will be shifted from the left side of the screen to the right and may be edited. The BACK key may be pressed all the way to the Program Header Screen.

7.9 LOOK

As you program each event, it is helpful to see your part drawn. For quick graphics while in the Program Mode, press the LOOK hard key.

This function is active at the end of each event, or whenever the conversation line is prompting Select Event. Press the LOOK key and the ProtoTRAK PMX CNC will draw the part. Press LOOK again, or BACK to bring back the Select Event screen. You may also select a new view or adjust the view.

Softkeys in LOOK:

ADJUST VIEW: gives additional options for adjusting the view of the drawing. See below.

FIT DRAW: automatically resizes the drawing to fit the entire part program on the screen.

LIST STEP: displays the list of events on the left side of the screen and with a purple highlight on the first event. As LIST STEP is pushed, the highlight shifts to the next event. As this happens, that event is also highlighted in the graphics by having its color change to purple.

START EVENT NUMBER: will prompt you to enter an event number for highlighting. This is useful for moving quickly to a particular event in a large program.

XY: displays a view in the XY plane.

YZ: displays a view in the YZ plane.

XZ: displays a view in the XZ plane.

3D: displays an isometric view

Softkeys in Adjust view:

FIT DRAW: automatically resizes the drawing to fit the entire part program on the screen.

ZOOM IN: makes the drawing larger.

ZOOM OUT: makes the drawing smaller.

RETURN: returns you to the first LOOK screen. The adjustments you made will stay on the screen until you press another selection that overrides those adjustments. The LIST STEP function may be used with the adjustment unaltered.

Use the arrow keys to shift the position of the drawing on the screen.

Note: The LOOK routine does not check for programming errors. Use Tool Path in the Set Up Mode to check movement of the tool.

8.0 Program Mode Part 2: Program Events

Events are fully defined pieces of geometry. By programming events, you tell the ProtoTRAK PMX CNC what geometry you want to end up with; it figures the tool path for you from your answers to the prompts and the tool information you give it in the Set-Up Mode.

8.1 POSN: Position Events

This event type positions the table and spindle at a specified position. The positioning is always at rapid speed (modified by feedrate override) and in the most direct path possible from the previous location. The most common use of the position event is to move the tool around an obstacle such as a clamp. For this reason, Z and X - Y motion will not occur simultaneously. First, the Z (head) will move to the higher of the Z rapid position of the current and next event, then the X (table) and Y (saddle) will move to the programmed position.

To program a Position event press the POSN soft key.

Prompts for the Position event:

X END is the X dimension to the position

Y END is the Y dimension to the position

Z Rapid is the Z dimension to the position

RPM is the spindle RPM for the event. INC SET will use the RPM of the previous event.

Tool # is the tool number you assign. SET will use the tool number of the previous event.

Note: the blue ? is active during the Tool # prompt. Pressing the HELP hard key will take you to a screen where you may view, edit or enter tool diameter and tool type.

NOTE - On all RPM line prompts for all events except tap, a blue “?” will be visible, which when pressed will allow the user to run the spindle in reverse. A “REV” prompt will show up in the event to the right of the RPM programmed.

8.2 DRILL Events

This event positions the table to the specified X and Y position, moves the spindle at rapid to the Z RAPID location, feeds the tool to the Z END location, and rapids back to Z RAPID for drill, and feeds back for bore.

Press the DRILL soft key.

Prompts for the drill event:

Drill=1, Bore=2: selects whether the hole is to be drilled or bored.

X: is the X dimension to the hole

Y: is the Y dimension to the hole

Z Rapid: is the Z dimension to transition from rapid to feed

Z End: is the bottom of the hole

Pecks for Drill: the factory setting is for each peck to be successively smaller, taking the largest cuts at the beginning and the smallest at the end. When the highlight is on this prompt, you may change this setting by pressing the HELP key. This will take you to a

screen where you may choose to have a fixed amount of material taken per peck or have the cutter move up just enough to break the chip before continuing to feed down.

RPM: is the spindle RPM for the event. INC SET will use the RPM of the previous event.

Z Feedrate: is the drilling feedrate

Tool #: is the tool number you assign

If a bore is selected and entered, you can change the tool path of the bore from the default tool path of feeding in and feeding out at the programmed rpm. After selecting Bore, use the cursor key to move over the prompt again. The blue ? will appear. Press HELP to be able to change the tool path to feed down, position away from the cut and then rapid out of the hole. The following prompts will appear:

Angle: is the angle from 3 o'clock CCW to the location of the cutting insert

Retract Dist: is the distance the cutting tool will retract towards the center of the bored hole.

Warning!

The boring tool you are using must be placed in the spindle consistently when using this feature. If you place the boring tool in the spindle 180° from how you set the tool up the first time, the cutting tool will crash into your workpiece.

8.3 BOLT HOLE Events

This event allows you to program a bolt hole pattern without needing to compute and program the position of each hole.

Prompts for the Bolt Hole event:

Drill=1, Bore=2, Tap = 3: selects whether the hole is to be drilled or bored

Once the bore is selected and entered, you can change the tool path of the bore from the default tool path of feeding in and feeding out at the programmed rpm. After selecting Bore, use the cursor key to move over the prompt again. The blue ? will appear. Press HELP to be able to change the tool path to feed down, position away from the cut and then rapid out of the hole.

Holes: is the number of holes in the bolt hole pattern

X Center: is the X dimension to the center of the hole pattern

Y Center: is the Y dimension to the center of the hole pattern

Z Rapid: is the Z dimension to transition from rapid to feed

Z Begin: appears for tapping only, this is the top of the work piece

Z End: is the bottom of the hole

Radius: is the radius of the hole pattern from the center to the center of the holes

Angle: is the angle from the positive X axes (that is, 3 o'clock) to any hole; positive angle is measured counterclockwise from 0.000 to 359.999 degrees, negative angles measured clockwise.

Pitch: is the pitch of the tap that is used if the Tap option is chosen.

of Variable Pecks: the factory setting is for each peck to be successively smaller, taking the largest cuts at the beginning and the smallest at the end. When the highlight is on this prompt, you may change this setting by pressing the HELP key. This will take you to a screen where you may choose to have a fixed amount of material taken per peck or have the cutter move up just enough to break the chip before continuing to feed down. RPM: is the spindle RPM for the event. INC SET will use the RPM of the previous event.

Z Feedrate: is the drilling feedrate

Tool #: is the tool number you assign

8.4 MILL Events

This event allows you to mill in a straight line from any one XYZ point to another, including at a diagonal in space. It may be programmed with a CONRAD if it is connective with the next event (this next event must lie in the same plane as the Mill event).

Prompts for the Mill Event:

X Begin: is the X dimension to the beginning of the mill cut

Y Begin: is the Y dimension to the beginning of the mill cut

Z Rapid: is the Z dimension to transition from rapid to feed

Z Begin: is the Z dimension to the beginning of the mill cut

X End: is the X dimension to the end of the mill cut; incremental is from X Begin

Y End: is the Y dimension to the end of the mill cut; incremental is from Y Begin

Z End: is the Z dimension to the end of the mill cut; incremental is from Z Begin.

Conrad: is the dimension of a tangential radius to the next event (that must lie in the same plane for part geometry programming)

Tool Offset: is the selection of the tool offset to right (input 1), offset to left (input 2), or tool center--no offset (input 0) relative to the programmed edge and direction of tool cutter movement and as projected in the XY plane.

RPM: is the spindle RPM for the event. INC SET will use the RPM of the previous event.

Z Feedrate: is the Z feedrate from Z Rapid to Z end in in/min from .1 to 700, or mm/min from 5 to 17780

XYZ Feedrate: is the milling feedrate from Begin to End in in/min from .1 to 800, or mm/min from 5 to 20320

Tool #: is the tool number you assign

Note: to program a series of connected lines and arcs on the same plane, use the Pocket or Profile events.

8.5 ARC Events

This event allows you to mill with circular contouring any arc (fraction of a circle) that lies in the XY plane or a vertical plane (see Section 5.3). Vertical plane arcs are also limited to those that are entirely concave or convex (in other words, if you think of the arc lying on the surface of the earth, then it can't cross the equator, again limited to quadrants surface of the earth , going from the equator to the South Pole).

In ARC events when X Center, Y Center, and Z Center are programmed incrementally, they are referenced from X End, Y End, and Z End respectively. An ARC event may be programmed with a CONRAD if it is connective with the next event (this next event must lie in the same plane as the Arc event).

Note: When an arc is 180 degrees, there are several paths that all have the same beginning, ending, and center locations. To illustrate, Imagine that if you were on the earth's equator and you wanted to get to the other side of the earth you could go clockwise or counterclockwise around the equator, or you could go up over the north pole, or down under the south pole. The ProtoTRAK PMX CNC will automatically assume that all 180 degree arcs that have the same beginning, ending and center dimensions for Z, lie in the XY plane. If you want a 180 degree arc in a vertical plane, you must program two 90 degree arcs or some equivalent.

Prompts for the Arc Event:

X Begin: is the X dimension to the beginning of the arc cut

Y Begin: is the Y dimension to the beginning of the arc cut

Z Rapid: is the Z dimension to transition from rapid to feed

Z Begin: is the Z dimension to the beginning of the arc cut.

X End: is the X dimension to the end of the arc cut; incremental is from X Begin

Y End: is the Y dimension to the end of the arc cut; incremental is from Y Begin

Z End: is the Z dimension to the end of the arc cut; incremental is from Z Begin.

X Center: is the X dimension to the center of the arc; incremental is from X End

Y Center: is the Y dimension to the center of the arc; incremental is from Y End

Z Center: is the Z dimension to the center of the arc; incremental is from Z End.

Conrad: is the dimension of a tangential radius to the next event (which must lie in the same plane)

Direction: is the clockwise (input 1), or counterclockwise (input 2) direction of the arc as viewed looking down for an arc in the XY plane, looking from the front for a vertical plane, or looking from the right for a vertical YZ plane

Tool Offset: is the selection of the tool offset to right (input 1), offset to left (input 2), or tool center--no offset (input 0) relative to the programmed edge and direction of tool cutter movement and as projected in the XY plane

RPM: is the spindle RPM for the event. INC SET will use the RPM of the previous event.

Z Feedrate: is the Z feedrate from Z Rapid to Z end in in/min from .1 to 700, or mm/min from 5 to 17780

XYZ Feedrate: is the milling feedrate from Begin to End in in/min from .1 to 800, or mm/min from 5 to 20320

Tool #: is the tool number you assign

Note: to program a series of connected lines and arcs on the same plane, use the Pocket or Profile events.

8.6 POCKET Events

This event selection gives you a choice between, circle pocket, rectangular pocket and irregular pocket within the XY plane.

Pockets include machining the circumference, as well as all the material inside the circumference of the programmed shape. If a finished cut is programmed, it will be made at the completion of the final pass. The cutter will arc in and arc out of the finish cut and position itself the finish cut dimension away from the part before moving the tool out of the part.

The factory setting for tool step over while machining a pocket is 70%. This may be changed. When you first enter the pocket event, the blue ? will appear next to the help key. Pressing Help will give you the choice of entering a new tool step over percentage. The value you enter here will remain the same until you change it again.

8.6.1 Circular Pocket

Press the CIRCLE PKCT soft key if you wish to mill a circular pocket.

Prompts for the Circle Pocket:

X Center: is the X dimension to the center of the circle

Y Center: is the Y dimension to the center of the circle

Z Rapid: is the Z dimension to transition from rapid to feed

Z End: is the Z dimension at the bottom of the pocket; incremental is from the previous event

Radius: is the finish radius of the circle

Direction: is the clockwise (input 1), or counterclockwise (input 2) direction for milling

Passes: number of cycles to machine to the final depth spaced equally from Z Rapid to Z End (hint: keep Z Rapid small)

Entry mode: choose between a zigzag ramp and a plunge. The plunge will machine straight down Z to the appropriate Z depth. The zigzag ramp will move in a zigzag pattern to depth. See Section 8.6.5 for more information about the zigzag ramp.

Fin Cut: is the width of the finish cut. If 0 is input, there will be no finish cut. See Section 8.6.7 for a bottom finish cut.

RPM: is the spindle RPM for the event. INC SET will use the RPM of the previous event.

FIN RPM: is the spindle RPM for the finish cut.

Z Feedrate: is the Z feedrate from Z rapid to Z end in in/min from .1 to 700, or mm/min from 5 to 17780

XYZ Feedrate: is the milling feedrate in in/min from .1 to 800, or mm/min from 5 to 20320

Fin Feedrate: is the milling feedrate for the finish cut

Tool #: is the tool number you assign

8.6.2 Rectangular Pocket

Press RECTANGLE soft key if you wish to mill a rectangular pocket (all corners are 90° right angles and the sides are parallel to the X and Y axes).

The prompts for the rectangular pocket:

X1: is the X dimension to any corner

Y1: is the Y dimension to the same corner as X1

X3: is the X dimension to the corner opposite X1; incremental is from X1

Y3: is the Y dimension to the same corner as X3; incremental is from Y1

Z Rapid: is the Z dimension to transition from rapid to feed

Z End: is the Z dimension at the bottom of the pocket; incremental is from the previous event

Conrad: is the value of the tangential radius in each corner

Direction: is the clockwise (input 1), or counterclockwise (input 2) direction for milling

Passes: is the number of cycles to machine to the final depth spaced equally from Z Rapid to Z End.

Entry mode: choose between a zigzag ramp and a plunge. The plunge will machine straight down Z to the appropriate Z depth. The zigzag ramp will move in a zigzag pattern to depth. See Section 8.6.5 for more information about the zigzag ramp.

Fin Cut: is the width of the finish cut. If 0 is input there will be no finish cut. See Section 8.6.7 for a bottom finish cut.

RPM: is the spindle RPM for the event. INC SET will use the RPM of the previous event.

FIN RPM: is the spindle RPM for the finish cut.

Z Feedrate: is the Z feedrate from Z rapid to Z end in in/min from .1 to 700, or mm/min from 5 to 17780

XYZ Feedrate: is the milling feedrate in in/min from .1 to 800, or mm/min from 5 to 20320

Fin Feedrate: is the milling feedrate for the finish cut

Tool #: is the tool number you assign

8.6.3 Irregular Pocket

Press the IRREG PCKT soft key if you wish to mill a pocket other than a rectangle or circle. The Irregular Pocket event gives you the powerful Auto Geometry Engine to define a shape made up of straight lines (Mills) and arcs.

The first screen in an Irregular Pocket event will define the beginning point and some of its general parameters. The last event of the irregular pocket must end at the same point as defined in the first event.

X Begin: is the X dimension of the beginning of the pocket

Y Begin: is the Y dimension of the beginning of the pocket

Z Rapid: is the Z dimension to transition from rapid to feed

Z End: is the Z dimension of the depth of the pocket.

Passes: is the number of cycles to machine to the final depth spaced equally from Z rapid to Z end (hint: keep Z Rapid small)

Entry Mode: choose between a zigzag ramp and a plunge. The plunge will machine straight down Z to the appropriate Z depth. The zigzag ramp will move in a zigzag pattern to depth. See Section 8.6.5 for more information about the zigzag ramp.

Fin Cut: is the width of the finish cut. If 0 is input there will be no finish cut. See Section 8.6.7 for a bottom finish cut.

RPM: is the spindle RPM for the event. INC SET will use the RPM of the previous event.

FIN RPM: is the spindle RPM for the finish cut. Z Feedrate: is the Z feedrate from Z rapid to Z end

XYZ Feedrate: is the milling feedrate in in/min from .1 to 800, or mm/min from 5 to 20320

Fin Feedrate: is the finish cut milling feedrate in in/min from .1 to 800, or mm/min from 5 to 20320

Tool #: is the tool number you assign

When the initial screen is complete, you will define the perimeter of the pocket with a series of A.G.E. Mills and A.G.E. Arcs. Programming with the Auto Geometry Engine is explained in Section 9.0.

No islands may exist in an irregular pocket.

8.6.4 Tool Path in Pocket Events

In Program Run, the pocket path will be either the plunge or zigzag cuts to Z depth along either the X or Y, followed by the required number of cuts to clear out the interior material, and then the rough cut along the inside of the perimeter. This will be repeated for each pass and then followed by a finish pass (if FIN CUT was not zero) along the inside of the perimeter at the Finish Feedrate and final depth. If a bottom finish cut was programmed, it will be machined before the perimeter finish cut.

Whether the cuts to clear the interior material of the irregular pocket are along the X or Y-axis depends on if there are hidden areas of the pocket. The ProtoTRAK PMX CNC always looks to cut along the X-axis first. If there are areas that are hidden to the X-axis, it will machine along the Y-axis. If there are hidden areas that cannot be machined continuously in the X or Y-axis, the tool will return to Z retract and then reposition to machine the hidden area.

8.6.5 Zigzag Z Depth Cuts

In programming pocket events, you have a choice to program the cuts to Z depth either as a plunge or a zigzag ramp. For rectangular and circular pockets, the tool will start in the center of the pocket. For irregular pockets, since there is no center defined, the tool will start in the lower left corner of the pocket. The direction of the ramp will be the same as the initial direction in either X or Y, depending on how the pocket is to be cut.

The tool will zigzag back and forth along the X or Y over a length of one tool radius while at the same time moving in the Z direction. When it travels one tool radius along this direction, it will have traveled a distance of ten percent of the tool diameter along the Z. This works out to roughly ramping into the part at an angle of 11 degrees.

In order to use a zigzag ramp, the X or Y move must be larger than the diameter of the tool plus the radius of the tool, minus the finish cut of the pocket. The formula is:

$$\text{the pocket x or y move} > \text{tool diameter} + \text{tool radius} - \text{fin cut}$$

If the tool is too large for the zigzag ramp, the ProtoTRAK PMX CNC will give an error message during program run and will then default to plunge. This will occur for each pass of the pocket depth.

8.6.6 Conrad in Pocket Events

A Conrad may be added to the last event of an Irregular Pocket. The Conrad will be inserted between the end of the last event and the beginning of the next event.

8.6.7 Bottom Finish Cut

The standard finish cut is along the walls of the part, but you may have the ProtoTRAK machine a finish cut along the bottom as well. When the highlight is on the Fin Cut prompt, the blue ? appears next to the Help key. Pressing help gives you the ability to choose a Finish cut in Z. You can remove the bottom finish cut by placing the highlight on the Fin Cut prompt and pressing Help again. When you select Yes to the bottom finish cut, the following prompt will appear:

Z FIN CUT: the finish cut at the bottom.

8.6.8 Face Mill Event

Press Face Mill soft key if you wish to face or clean up the top of a workpiece.

The cutter will automatically start off of the part that you define. The cutter will move along the X axis to remove the material starting from where you defined X1, Y1 and finishing at the corner programmed as X3, Y3.

The prompts for the face mill:

X1: is the X dimension to any corner

Y1: is the Y dimension to the same corner as X1

X3: is the X dimension to the corner opposite X1; incremental is from X1

Y3: is the Y dimension to the same corner as X3; incremental is from Y1

Z Rapid: is the Z dimension to transition from rapid to feed

Z End: is the Z dimension at the bottom of the pocket; incremental is from the previous event

Passes: is the number of cycles to machine to the final depth spaced equally from Z Rapid to Z End.

Z Fin Cut: is the depth of the finish cut. If 0 is input there will be no finish cut.

RPM: is the spindle RPM for the event. INC SET will use the RPM of the previous event.

FIN RPM: is the spindle RPM for the finish cut.

Z Feedrate: is the Z feedrate from Z rapid to Z end in in/min from .1 to 700, or mm/min from 5 to 17780

XYZ Feedrate: is the milling feedrate in in/min from .1 to 800, or mm/min from 5 to 20320

Fin Feedrate: is the milling feedrate for the finish cut

Tool #: is the tool number you assign

Note – if you press the HELP key when you are on the X1 prompt, you can adjust the step over distance of the face mill. The default is 95% of the cutter width. You can adjust it from 1 to 99%.

8.7 ISLAND Events

Within the Pocket event choices, you may also select a circular, rectangular or irregular island. An Island is a shape that is left standing when the surrounding material is removed. The ProtoTRAK gives you the ability to machine almost any shape as an island within a rectangular pocket. Both the shape of the island and the dimension of the surrounding pocket are defined within the Island Event.

The tool path for machining the Island Event is that the tool will first plunge or ramp into the material next to the island, offset by the programmed finish cut, to the depth of the first pass. The tool will machine the perimeter of the island, offset by the island finish cut. Then the tool will machine the material in the pocket in a spiral path, moving away from the island in the programmed clockwise or counterclockwise direction. It will continue this outward spiral motion until it encounters the programmed rectangular perimeter (or pocket). It will then follow the perimeter, offset by the pocket finish cut.

It will proceed in this manner through the number of programmed passes. On the final pass, it will machine the island finish cut, then the pocket finish cut. If a Z finish cut is programmed, it will do this in the same spiral pattern as the roughing passes between machining the island and pocket finish cuts. The tool will ramp away from the finish cut by the amount of the finish cut before it raises out of the part.

8.7.1 Circular Island

Press the CIRCLE ISLAND soft key if you wish to mill a circular island.

Prompts for the Circle Pocket:

X CENTER: is the dimension of the center of the Island

Y CENTER: is the dimension of the center of the Island

Z RAPID: is the Z dimension of the transition from rapid to feed

Z END: is the Z dimension at the bottom of the pocket; incremental is from the previous event

RADIUS: is the finish radius of the Island

DIRECTION: is the milling direction, clockwise or counterclockwise

#PASSES: the number of roughing passes to the depth

ENTRY MODE: choose between zigzag ramp and plunge. The plunge will machine straight down Z to the appropriate Z depth. The zigzag ramp will move in a zigzag pattern to depth. See the previous section for more information about the zigzag ramp.

FIN CUT ISL: Finish cut for the Island. If 0 is input, there will be no finish cut. See the previous section for a bottom finish cut.

X1 POCKET: X dimension for one corner of the rectangular pocket that surrounds the island.

Y1 POCKET: Y dimension for one corner of the rectangular pocket that surrounds the island.

X3 POCKET: X dimension for the opposite corner of the rectangular pocket that surrounds the island.

Y3 POCKET: Y dimension for the opposite corner of the rectangular pocket that surrounds the island.

CONRAD PCKT: the value of the tangential radius in the corners of the rectangular pocket that surrounds the island.

FIN CUT PCKT: finish cut along the perimeter of the pocket. If 0 is input, there will be no finish cut. See the previous section for a bottom finish cut.

RPM is the spindle RPM for the event. INC SET will use the RPM of the previous event.

FIN RPM: is the spindle RPM for the finish cut.

Z FEEDRATE: is the Z feedrate from Z rapid to Z end in in/min from .1 to 700, or mm/min from 5 to 17780.

XYZ FEEDRATE: the milling feedrate in in/min from .1 to 800, or mm/min from 5 to 20320

FIN FEEDRATE: the finish milling feedrate for both the island and pocket finish cuts

TOOL #: is the tool number you assign.

8.7.2 Rectangular Island

Press the RECT ISLAND softkey if you wish to machine a rectangular island.

Prompts for the RECT ISLAND:

X1 Island: X dimension for one corner of the rectangular island.

Y1 Island: Y dimension for one corner of the rectangular island.

X3 Island: X dimension for the opposite corner of the island.

Y3 Island: Y dimension for the opposite corner of the island.

Z RAPID: is the Z dimension of the transition from rapid to feed

Z END: is the Z dimension at the bottom of the pocket; incremental is from the previous event

CONRAD ISL: the value of the tangential radius in the corners of the island.

DIRECTION: is the milling direction, clockwise or counterclockwise

#PASSES: the number of roughing passes to the depth

ENTRY MODE: choose between zigzag ramp and plunge. The plunge will machine straight down Z to the appropriate Z depth. The zigzag ramp will move in a zigzag pattern to depth. See the previous section for more information about the zigzag ramp.

FIN CUT: Finish cut for the Island. If 0 is input, there will be no finish cut. See the previous section for a bottom finish cut.

X1 POCKET: X dimension for one corner of the rectangular pocket that surrounds the island.

Y1 POCKET: Y dimension for one corner of the rectangular pocket that surrounds the island.

X3 POCKET: X dimension for the opposite corner of the rectangular pocket that surrounds the island.

Y3 POCKET: Y dimension for the opposite corner of the rectangular pocket that surrounds the island.

CONRAD PCKT: the value of the tangential radius in the corners of the rectangular pocket that surrounds the island.

FIN CUT PCKT: finish cut along the perimeter of the pocket. If 0 is input, there will be no finish cut. See the previous section for a bottom finish cut.

RPM: is the spindle RPM for the event. INC SET will use the RPM of the previous event.

FIN RPM: is the spindle RPM for the finish cut.

Z FEEDRATE: is the Z feedrate from Z rapid to Z end in in/min from .1 to 700, or mm/min from 5 to 17780.

XYZ FEEDRATE: the milling feedrate in in/min from .1 to 800, or mm/min from 5 to 20320

FIN FEEDRATE: the finish milling feedrate for both the island and pocket finish cuts

TOOL #: is the tool number you assign.

8.7.3 Irregular Island

Press the IRREG ISLAND key if you wish to mill an island other than a rectangle or circle. The Irregular Island gives you the powerful Auto Geometry Engine to define a shape made up of straight lines and arcs.

The first screen in an Irregular Island event will define the beginning point and some of its general parameters. The last event of the irregular island must end at the same point as defined in the first event.

Prompts for the Irregular Island event:

X BEGIN: X dimension to the beginning of the island.

Y BEGIN: Y dimension to the beginning of the island.

Z RAPID: is the Z dimension of the transition from rapid to feed

Z END: is the Z dimension at the bottom of the pocket; incremental is from the previous event

#PASSES: the number of roughing passes to the depth

ENTRY MODE: choose between zigzag ramp and plunge. The plunge will machine straight down Z to the appropriate Z depth. The zigzag ramp will move in a zigzag pattern to depth. See the previous section for more information about the zigzag ramp.

FIN CUT: Finish cut for the Island. If 0 is input, there will be no finish cut. See the previous section for a bottom finish cut.

X1 POCKET: X dimension for one corner of the rectangular pocket that surrounds the island.

Y1 POCKET: Y dimension for one corner of the rectangular pocket that surrounds the island.

X3 POCKET: X dimension for the opposite corner of the rectangular pocket that surrounds the island.

Y3 POCKET: Y dimension for the opposite corner of the rectangular pocket that surrounds the island.
CONRAD PCKT: the value of the tangential radius in the corners of the rectangular pocket that surrounds the island.
FIN CUT PCKT: finish cut along the perimeter of the pocket. If 0 is input, there will be no finish cut. See the previous section for a bottom finish cut.
RPM: is the spindle RPM for the event. INC SET will use the RPM of the previous event.
FIN RPM: is the spindle RPM for the finish cut.
Z FEEDRATE: is the Z feedrate from Z rapid to Z end in in/min from .1 to 700, or mm/min from 5 to 17780.
XYZ FEEDRATE: the milling feedrate in in/min from .1 to 800, or mm/min from 5 to 20320.
FIN FEEDRATE: the finish milling feedrate for both the island and pocket finish cuts.
TOOL #: is the tool number you assign.

When the initial screen is complete, you will define the perimeter of the island with a series of A.G.E. Mills and A.G.E. Arcs. Programming with the Auto Geometry Engine is explained in Section 9.0.

8.8 PROFILE Events

This event allows you to mill around the outside or inside of a circular or rectangular frame or an irregular profile. The irregular profile may be closed or open. All profiles are limited to the XY plane.

When the irregular profile event is started the ProtoTRAK PMX CNC will automatically initiate the powerful Auto Geometry Engine. See Section 9.0 for programming with A.G.E.

8.8.1 Circle Profile

Press the CIRCLE soft key if you wish to mill a circular frame.

Prompts in the Circle Profile event:

X Center: is the X dimension to the center of the circle

Y Center: is the Y dimension to the center of the circle

Z Rapid: is the Z dimension to transition from rapid to feed

Z End: is the Z dimension to the bottom of the frame; incremental is from the previous event

Radius: is the finish radius of the circle

Direction: is the clockwise (input 1), or counterclockwise (input 2) direction for milling

Tool Offset: is the selection of the tool offset to the right (input 1), offset to the left (input 2), or tool center--no offset (input 0) relative to the programmed edge and direction of the cutter movement

Passes: is the number of cycles to machine to the final depth spaced equally from Z Rapid to Z End (hint: keep Z Rapid small)

Fin Cut: is the width of the finish cut. If 0 is input, there will be no finish cut

RPM: is the spindle RPM for the event. INC SET will use the RPM of the previous event.

FIN RPM: is the spindle RPM for the finish cut.

Z Feedrate: is the Z feedrate from Z rapid to Z end in in/min from .1 to 700, or mm/min from 5 to 17780

XYZ Feedrate: is the milling feedrate in in/min from .1 to 800, or mm/min from 5 to 20320

Fin Feedrate: is the milling feedrate for the finish cut

Tool #: is the tool number you assign

8.8.2 Rectangular Profile

Press the RECTANGLE soft key if you wish to mill a rectangular frame (all corners are 90 degree right angles).

Prompts for the rectangular profile:

X1: is the X dimension to any corner

Y1: is the Y dimension to the same corner as X1

X3: is the X dimension to the corner opposite X1; incremental is from X1

Y3: is the Y dimension to the same corner as X3; incremental is from Y1

Z Rapid: is the Z dimension to transition from rapid to feed

Z End: is the Z dimension at the bottom of the frame; incremental is from the previous event

Conrad: is the value of the tangential radius in each corner

Direction: is the clockwise (input 1), or counterclockwise (input 2) direction for milling

Tool Offset: is the selection of the tool offset to the right (input 1), offset to the left (input 2), or tool center--no offset (input 0) relative to the programmed edge and direction of the cutter movement

Passes: is the number of cycles to machine to the final depth spaced equally from Z Rapid to Z End (hint: keep Z Rapid small)

Fin Cut: is the width of the finish cut. If 0 is input, there will be no finish cut

RPM: is the spindle RPM for the event. INC SET will use the RPM of the previous event.

FIN RPM: is the spindle RPM for the finish cut.

Z Feedrate: is the Z feedrate from Z rapid to Z end in in/min from .1 to 700, or mm/min from 5 to 17780

XYZ Feedrate: is the milling feedrate in in/min from .1 to 800, or mm/min from 5 to 20320

Fin Feedrate: is the milling feedrate for the finish cut (if programmed).

Tool #: is the tool number you assign

8.8.3 Irregular Profile

Press the IRREG PROFILE soft key if you wish to mill a profile other than a rectangle or circle. The Irregular Profile event gives you the powerful Auto Geometry Engine to define a shape made up of straight lines (Mills) and arcs.

The Irregular Profile is a series of events that are programmed to machine continuously. The first event of the series will be called an IRR PROFILE and it will define the beginning point of the profile and other information that applies to the entire profile.

X Begin: is the X dimension of the beginning of the profile

Y Begin: is the Y dimension of the beginning of the profile

Z Rapid: is the Z dimension to transition from rapid to feed

Z End: is the Z dimension of the depth of the profile

Tool Offset: is the selection of the tool offset to right (input 1), offset to left (input 2), or tool center--no offset (input 0) relative to the programmed edge and direction of tool cutter movement

Passes: is the number of cycles to machine to the final depth spaced equally from Z rapid to Z end (hint: keep Z Rapid small)

Fin Cut: is the width of the finish cut. If 0 is input there will be no finish cut

RPM: is the spindle RPM for the event. INC SET will use the RPM of the previous event.

FIN RPM: is the spindle RPM for the finish cut.

Z Feedrate: is the Z feedrate from Z rapid to Z end in in/min from .1 to 700, or mm/min from 5 to 17780

XYZ Feedrate: is the milling feedrate in in/min from .1 to 800, or mm/min from 5 to 20320

Fin Feedrate: is the finish cut milling feedrate in in/min from .1 to 800, or mm/min from 5 to 20320

Tool #: is the tool number you assign

When the initial Irregular Profile screen is complete, the rest of the profile is programmed using A.G.E. Mill and A.G.E. Arc events. Programming with the Auto Geometry Engine is explained in Section 9.0.

8.9 HELIX Events

The HELIX Event is found after you press the MORE softkey from the Select Event screen. It allows you to machine in a circular path in the XY plane while you simultaneously move the Z-axis linearly.

Press the HELIX soft key.

X Center: is the X dimension to the center of rotation of the helix

Y Center: is the Y dimension to the center of rotation of the helix

Z Rapid: is the Z dimension to transition from rapid to feed

Z Begin: is the Z dimension to the beginning of the helix

Z End: is the Z dimension at the end of the helix

Radius: is the radius from the center of rotation to the helix

Angle: is the angle from the positive X axis (that is, 3 o'clock) to the starting position of the helix

Rev: is the number of revolutions in the helix, for example, 0.75 would be 270 degrees, or 3.25 would be three times around plus 90 degrees

Direction: is the clockwise (input 1) or counterclockwise (input 2) direction of the helix

Tool Offset: is the selection of the tool offset to right (input 1), offset to left (input 2), or tool center--no offset (input 0) relative to the programmed edge and direction of the cutter movement

RPM: is the spindle RPM for the event. INC SET will use the RPM of the previous event.

Z Feedrate: is the Z feedrate from Z rapid to Z end in in/min from .1 to 700, or mm/min from 5 to 17780

XYZ Feedrate: is the feedrate from beginning to end in in/min from .1 to 800, or mm/min from 5 to 20320

Tool #: is the tool you assign

8.10 Subroutine Events

The Subroutine Events are used for manipulating previously programmed geometry within the XY plane.

The Subroutine Event is divided into three options: Repeat, Mirror, and Rotate.

Repeat and Rotate may be connective. As long as the rules of connectivity are satisfied (see Section 5.9), the ProtoTRAK PMX CNC will continue milling between preceding and subsequent events.

REPEAT allows you to repeat an event or a group of events up to 99 times with an offset in X and/or Y and/or Z. This can be useful for drilling a series of evenly spaced holes, duplicating some machined shapes, or even repeating an entire program with an offset for a second fixture.

Repeat events may be "nested." That is, you can repeat a repeat event, of a repeat event, of some programmed event(s). One new tool number may be assigned for each Repeat Event.

MIRROR is used for parts that have symmetrical patterns or mirror image patterns. In addition to specifying the events to be repeated, you must also indicate the axis or axes (X or Y or XY are allowed) that the reflection is mirrored across. In addition, you must specify the offset from absolute zero to the line of reflection. You may not mirror another mirror event, or mirror a rotate event. Consider the figure below:

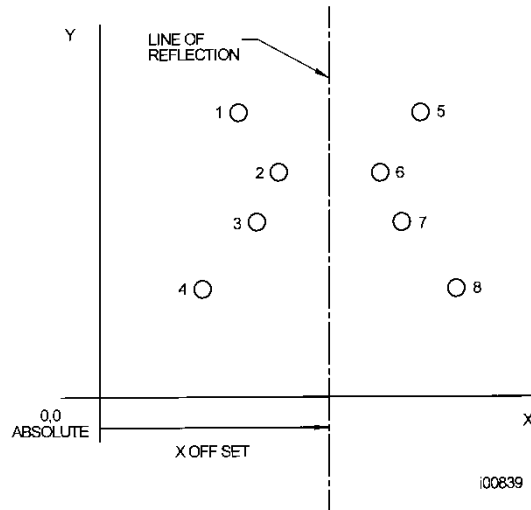

Above, holes 1-4 are mirrored across the Y axis to 5-8, respectively, about a line X OFFSET from X=absolute 0

ROTATE is used for polar rotation of parts that have a rotational symmetry around some point in the XY plane. In addition to specifying the events to be repeated, you must also indicate the absolute X and Y position of the center of rotation, the angle of rotation (measured counterclockwise as positive; and clockwise as negative), and the number of times the specified events are to be rotated and repeated. You may not rotate another rotate event, however you can rotate a mirror event. Consider the figure below:

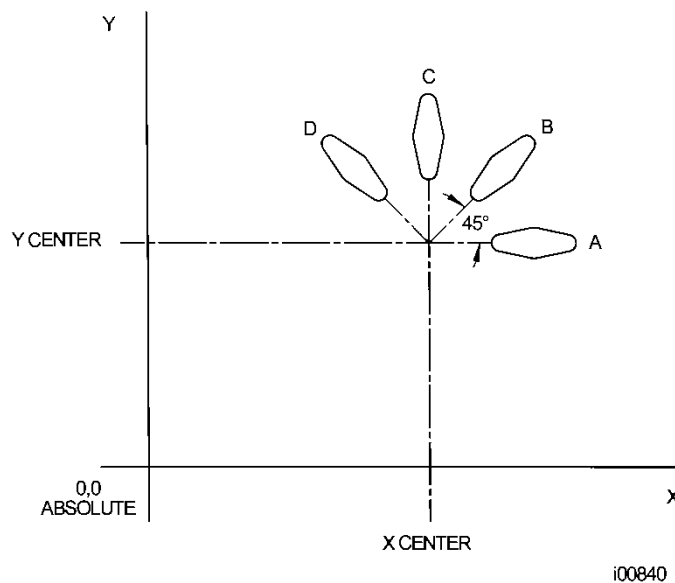

Shape A programmed with 4 MILL events and Conrads. Using ROTATE, these 4 events are rotated through a 45 degree angle about a point offset from absolute zero by X Center and Y Center dimensions. A is rotated 3 times to produce shape B, C, and D

Press the SUBROUTINE (SUB) soft key to call up the Repeat, Mirror, and Rotate options.

8.10.1 REPEAT

Press the REPEAT soft key.

Where:

First Event #: is the event number of the first event to be repeated

Last Event #: is the event number of the last event to be repeated; if only one event is to be repeated, the Last Event # is the same as the First Event #

X Offset: is the incremental X offset from event to be repeated

Y Offset: is the incremental Y offset from event to be repeated

Z Offset: is the incremental Z offset from event to be repeated

Z Rapid Offset: is the incremental Z rapid offset from event to be repeated

Repeats: is the number of times events are to be repeated up to 99

% RPM: is the percentage of RPM in the programmed events. SET will load in the assumed % of 100%.

% Feed: the percentage of the feeds programmed in the repeated events. 100% is assumed

Tool #: is the tool number you assign

8.10.2 MIRROR

Press the MIRROR soft key.

First Event #: is the event number of the first event to be mirrored

Last Event #: is the event number of the last event to be mirrored; if only one event is to be mirrored, the last event is the same as the first.

Cutting Order: input 1 to cut from the lowest mirrored event to the highest (forward) and 2 to machine from the highest mirrored event to the lowest (backward).

This way you can keep all the machine motion in a consistent direction as it moves from the original shape to the mirrored shape and keep all cutting either climb or conventional.

Mirror Axis: is the selection of the axis or axes to be mirrored (input X or Y or XY, SET)

X Offset: is the distance from Y absolute 0 to the Y-axis line of reflection

Y Offset: is the distance from X absolute 0 to the X-axis line of reflection

8.10.3 ROTATE Z Axis

Press the ROTATE soft key.

First Event #: is the event number of the first event to be rotated

Last Event #: is the event number of the last event to be rotated; if only one event is to be rotated, the last event is the same as the first

X Center: is the X absolute position of the center of rotation

Y Center: is the Y absolute position of the center of rotation

Angle: is the angle of rotation of the repeated events (positive is counterclockwise; negative is clockwise)

Repeats: is the number of times events are to be rotated up to 99

8.11 COPY Events

Copy Events are programmed exactly like Subroutine Events. The only difference is that in Copy the events are rewritten into subsequent events. If, for example, in event 11 you copy repeated events 6, 7, 8, 9, 10 with 2 repeats, events 6-10 would be copied with the input offsets into events 11-15, and recopied into 16-20.

Copy Events may be REPEAT, MIRROR, ROTATE or DRILL to TAP.

Copy is very useful. With Copy you can:

- Edit the events that are being repeated, mirrored or rotated without changing the original events.
- Program an event parallel to X or Y (where the geometry is the easiest to describe), rotate it to the desired position, then delete the original.
- Use the clipboard to paste previously stored events from another program into the current program. After you press the CLIPBOARD key, you will enter the offset from the previous program's absolute zero to the current program's absolute zero (see figure below). For information about putting events into the clipboard, see Section 10.4.

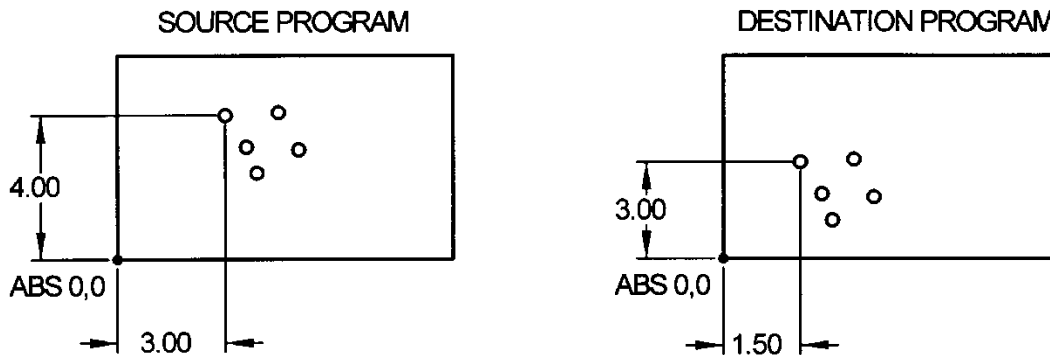

i00965

In the above example, the offset that puts the group of holes in the desired location is $X=-1.50$ and $Y=-1.00$.

8.11.1 Copy Drill to Tap

The copy drill to tap feature allows you to convert a series of drill events over to a tap event. Prompts in this event.

First Event #: is the event number of the first drill event to be copied

Last Event #: is the event number of the last drill event to be repeated; if only one event is to be repeated, the Last Event # is the same as the First Event #

Z Rapid: is the Z dimension to transition from rapid to feed. Make sure that Z rapid is set high enough to compensate for the amount of float in the floating tapping head.

Z End: the depth of the thread

PITCH - the distance from one thread to the next in inches or mm. It is equal to one divided by the number of threads per inch. For example, the pitch for a 1/4-20 screw is $1 \div 20 = .05$ inches

RPM: spindle RPM

Tool #: is the tool number you assign

8.12 THREAD MILL Event

To program a Thread Mill Event press the THREAD MILL soft key. This event includes an automatic move in and out by 0.050" of the thread. Prompts in the Thread Mill Event:

X CENTER: the X dimension of the center of the thread

Y CENTER: the Y dimension of the center of the thread

Z RAPID: the Z dimension where the Z rapid feed slows to Z program feed

Z BEGIN: the Z dimension where the threading pass begins

Z END: the Z bottom of the thread

DIRECTION: clockwise or counterclockwise

PITCH: the distance from one thread to the next in inches or mm. It is equal to one divided by the number of threads per inch. For example, the pitch for a 1/4-20 screw is $1/20 = .05$ inches

MAJOR DIA: the largest diameter of the thread (the root for an ID thread, the crest for an OD thread)

MINOR DIA: the smallest diameter of the thread (the root for an OD thread, the crest for an ID thread)

SIDE: input 1 for inside, 2 for outside

ANGLE: the angle the tool feeds into the beginning depth

PASSES: - the number of passes to cut the thread to its final depth

FIN CUT: width of the finish cut. If 0 is input, there is no finish cut.

Z FEEDRATE: is the Z feedrate from Z rapid to Z end in in/min from .1 to 700, or mm/min from 5 to 17780

XYZ FEEDRATE: The feedrate of XYZ along the path of the helix.

If something other than 0 is input for finish cut, the following prompt appears:

FIN FEEDRATE: the milling feedrate for the finish cut.

RPM: is the spindle RPM for the event. INC SET will use the RPM of the previous event.

FIN RPM: is the spindle RPM for the finish cut.

TOOL#: is the tool number you assign.

8.13 PAUSE Events

The purpose of the Pause Event is to allow you to program a stop condition within the program. The Pause event will stop the program where it ended at the previous event. If you open the door during a Pause Event the spindle and coolant will turn off

Pause Events are useful if you want to stop the program to make a measurement, change a fixture, etc.

NOTE: In general, you should avoid programming a Pause Event between two connective events. The Pause Event will cause the events to NOT be connective.

To program a Pause Event press the PAUSE softkey. Because there is no input required, simply press SET to load and the event counter will advance by one and the Select Event screen will reappear.

In run, press the GO key after a pause to continue.

8.14 TAP Events

Tap Events allow rigid tapping. The feedrate of the thread will be calculated from the pitch and RPM entered. The RPM range that the ProtoTRAK PMX is from 150 to 2000 rpm. An error message will occur if you try to tap outside of these ranges.

To program a tap event press the TAP softkey.

Prompts in the Tap event:

X: the X dimension to the center of the hole (Help key active and allows the selection of a left-hand thread).

Y: the Y dimension to the center of the hole

Z Rapid: is the Z dimension to transition from rapid to feed.

Z Begin: the top of the work piece

Z End: the depth of the thread

PITCH - the distance from one thread to the next in inches or mm. It is equal to one divided by the number of threads per inch. For example, the pitch for a 1/4-20 screw is $1/20 = .05$ inches

RPM: spindle RPM

Tool #: is the tool number you assign

8.14.1 Tapping Notes and Recommendations

- Harder materials will require slower speeds and tap size may also be limited.
- Make sure your tap is not dull. Dull taps will require more torque to cut and may not cut threads to specification.
- Cutting oil will play a large role in determining the size of tap you can use in a given material.
- Make sure your tap is running true in the holder.
- The tap has to attain sufficient speed as it is entering the work piece. The ProtoTRAK PMX CNC will automatically calculate the distance required to gain momentum and that distance may be different than the programmed Z Rapid. (That is why we require the Z Begin dimension).
- Selecting Help (blue question mark) at the first prompt of the Tap event will give you the ability to switch to a left-hand thread. This choice is not available in the Tap option of the Bolt Hole event.

8.15 ENGRAVE Event

The Engrave Event allows you to machine numbers, letters and special characters as part of a part program. See below for the letters and special characters that are available in the Engrave Event.

When programming with the Engrave Event, the ProtoTRAK will construct a box to contain the text you define. This box is oriented along the X axis like the text in this sentence, and you may program up to 40 characters per event (although you will only be able to see 20 characters on the prompts screen). To machine text in a direction other than the X axis, simply use multiple Engrave Events and place the lower left corner of the box wherever you would like. The numbers and letters you program will always have a standard orientation (like the letters on this page) – you cannot program tilted or inverted letters with the Engrave Event. The letters are of the font shown in the figure and all capitals.

Prompts for the Engrave Event:

First, define the lower left corner of the box that will contain your text:

X BEGIN: The X coordinate of where you want your text to begin

Y BEGIN: The Y coordinate of where you want your text to begin

Z RAPID: The Z dimension where the Z rapid feed slows to Z program feed

Z END: The Z dimension to the bottom of your text.

HEIGHT: The height of your text. Each character varies in width; the set height of the character will change the width in order to keep the overall size of the character proportional.

TEXT: The text to be milled. When you get to this prompt, the Alpha keys will automatically pop up to allow you to enter the text. Once you have finished entering text, you must press End and then any of the SET keys to successfully enter your text into the event. The alpha keys will appear automatically if the text field is blank. If you have already entered text but wish to make a change, you will see a blue question mark appear on the lower left corner of the screen when you scroll to this field, press the Help button and the alpha keys will appear.

RPM: is the spindle RPM for the event. INC SET will use the RPM of the previous event.

Z FEEDRATE: is the Z feedrate from Z rapid to Z end in in/min from .1 to 800, or mm/min from 5 to 20320.

XYZ FEEDRATE: The feedrate of XYZ along the path of the text

Tool #: is the tool number you assign



The above figure shows the text and special characters available for the Engrave event. Notice the field that is labeled “Text Length”. This field will display the total length of your programmed text and will update as you enter each character.

8.16 Auxiliary (AUX) Functions Event

Auxiliary operations are programmed as events in the ProtoTRAK PMX CNC to make it easier to turn functions on and off for the entire program.

When running programs with Auxiliary functions, the Coolant and Air hard keys on the Run panel must be in the correct position. If you want the program to automatically turn the Auxiliary functions on and off, press the hard key until the light is on in the AUTO position.

Auxiliary Event options:

Input	Function	Comments
1	Coolant	The coolant pump will be turned on when this event begins to run.
2	Air on	The air solenoid will be turned on when this event begins to run.
3	Coolant Off	Turns the coolant off at the end of this event.
4	Air Off	Turns the air solenoid off at the end of this event.
5	Pulse Indexer	Activates a 0.3 second electronic pulse at the beginning of the event. See note below.
6	Part Change	Brings the table and saddle forward for convenient access to the fixture

	Position	or work piece. The position along the X axis may be changed using a Service Code.
7	4 th Axis Auto Clamp OFF	Turns off the auto clamp feature on 4 th axis units that require air to run.
8	4 th Axis Auto Clamp ON	Turns on the auto clamp feature on 4 th axis units that require air to run. The default if no AUX event is program is to auto clamp.
9	Cornering – Blend or Exact Stop	Allows the program to blend a corner or exact stop in the corner. When you blend moves, some accuracy will be lost. This cornering AUX really only applies or has an impact when S curves are turned on in service code 508. See S curve section below.

Coolant/Air on and off is automatically programmed for tool changes.

The Pulse Indexer function is designed to operate with a standard indexer. Programming a Pulse Indexer will cause the ProtoTRAK PMX CNC send a signal to the connected indexer or rotary table and then wait for the return signal that the devise has finished its programmed move. The ProtoTRAK PMX CNC then it will resume machining at the next event.

S Curve Information – turned on and off with service code 508

1. S curves are utilized when your feedrate is greater than 40 ipm. For feedrates below 40 ipm, there is no value to S curves. The surface finish seen under a end mill is generally improved when S curves are used.
2. In our AUX event, we have added a new prompt under 9 that gives the user the choice to have the control perform corner blending (G64) or exact stop (G61). The default is exact stop when S curve is turned on and this applies to feedrates that are greater than 40 ipm. Please see the figure below for how the AUX event looks.
 - a. Exact stop means the control will get into exact position and there will be minimal error. This may add some additional time to run a program versus if blending is used or if S curves were turned off.
 - b. Corner blending will make the machine blend or round a corner. The machine will not get into exact position and hence you will see some error when machining. The error is dependent on the feedrate you are machining at. The higher the feedrate, the more error you will see. With corner blending on, the machine will not slow down as much in the corners and your cycle time will be faster. Please note that cornering error will only show up at feedrates above 40 ipm.
 - c. Please note that G61 exact stop and G64 corner blending are common G codes found on many CNC controls and not unique to Southwestern Industries. G64 is often labeled as G61 cancel versus the corner blending term we use but it is in essence the same thing.

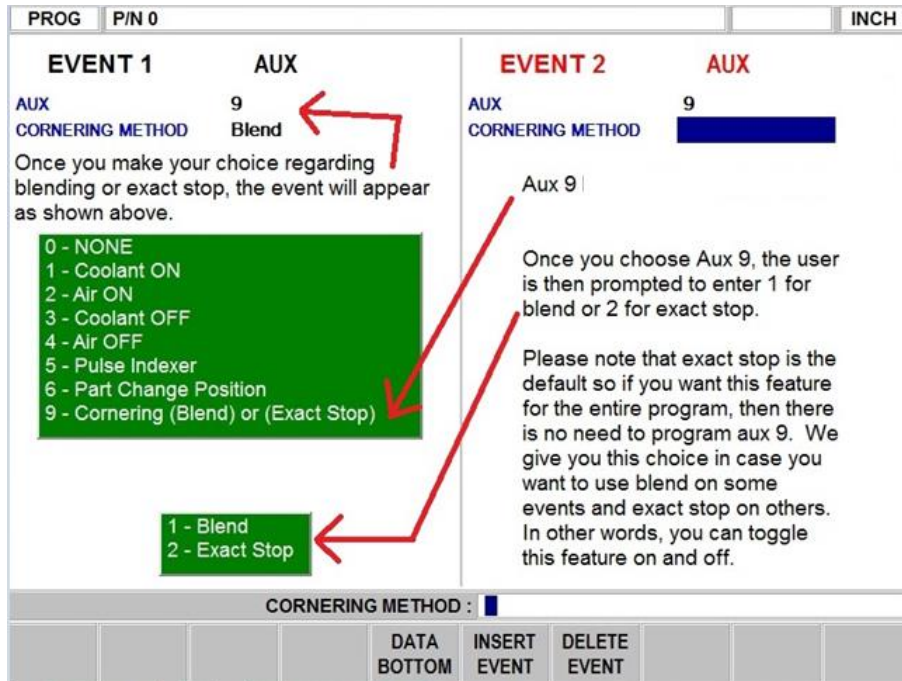

3. Please note that if you do use corner blending in your program, we will automatically get into exact position on the following moves or events.
 - a. Bore and drill event – the final depth that you program in your event will get into exact position.
 - b. All position or rapid moves will get into exact position. For example, if you are rapiding out of a hole in Z and then positioning in X and Y to a new hole location, the control will get into exact position. You don't have to worry about the control rounding the corner if you have corner blending on.
 - c. All individual Z moves that lead into XY moves will get into exact position. For example, when you feed down to the bottom of any pocket or profile, we will get into exact position before moving the X or Y axis.
 - d. Helix and thread mill events will get into exact position at the beginning and end of the event.
 - e. Please note that when you are using tool compensation (tool right or tool left) and making a sharp outside corner, we generate a walk around arc to create the corner. This means the error will be minimal with corner blending turned on.
4. The following are the some notes about how exact stop (G61) works.
 - a. Exact stop will only be used when the machine makes a change of direction where the angle between the line you are on to the next line is less than 170 degrees or larger than 190 degrees. See the illustration below for what this specifically means.

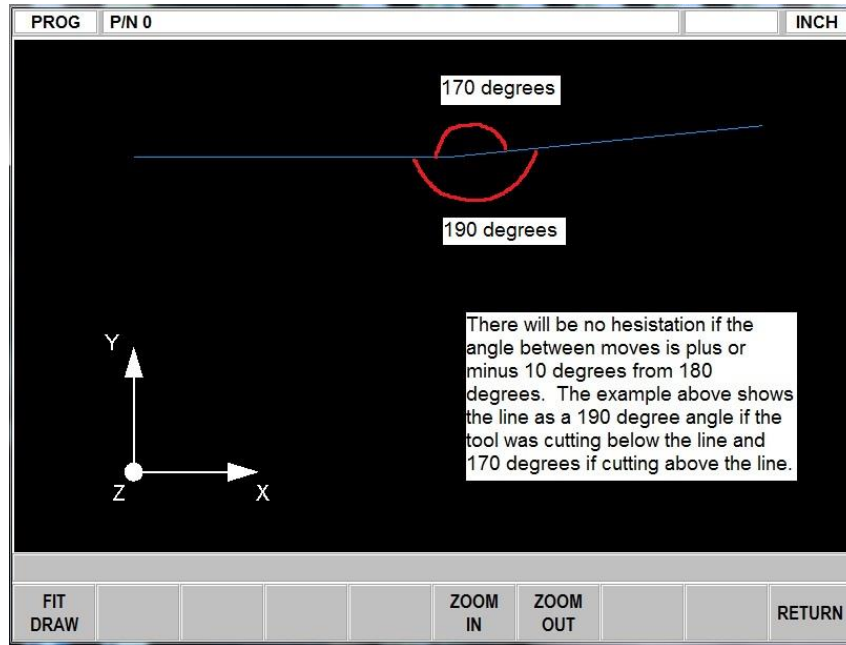

- b. Surfacing type programs that are comprised of small moves that have small angles between the moves should not require a G64 or corner blending to be turned on to avoid hesitation.
- c. All moves that are tangent to each other also will not have exact stop (G61) apply. Please note that when making a 90° outside corner with tool compensation applied, we generate an arc to machine the sharp corner so these moves are tangent.
- d. For all moves where exact stop will apply, the user may notice a slight hesitation on these moves. This is due to the control getting into exact position before performing the next move.

9.0 Program Mode

Part 3: The Auto Geometry Engine (A.G.E.) Programming

This entire section deals with the Auto Geometry Engine which is automatically started when you program an Irregular Pocket (Section 8.6.3) or an Irregular Profile (Section 8.8.3).

The A.G.E. is powerful software that works behind the easy-to-use geometry programming of the ProtoTRAK PMX CNC. It is treated in its own section because it works differently than the other event types. Unlike other events, the A.G.E. allows you to:

- Enter the data you know, and skip the prompts you don't.
- Use different types of data (like angles) that may be available from the print.
- Enter guesses for the X and Y ends and centers not available on the print.

With the A.G.E., you can easily overcome limitations in the data the print provides without having to spend time in laborious calculations.

9.1 Starting the A.G.E.

The A.G.E. is started automatically when you enter the Irregular Pocket or Irregular Profile event. The first set of prompts you encounter will be the header information. Once that information is entered, you will see the following screen:

PROG	P/N 0			INCH
EVENT 2	IRR PCKT	EVENT 3		
X BEGIN	2.0000	abs		
Y BEGIN	3.0000	abs		
Z RAPID	2.0000	abs		
Z END	1.0000	abs		
# PASSES	1			
ENTRY MODE	PLUNGE			
FIN CUT	0.0000			
RPM	2000.00			
Z FEEDRATE	25.0			
XYZ FEEDRATE	30.0			
TOOL #	2			
Select an event.				
A.G.E. MILL	A.G.E. ARC			
			END A.G.E.	ABORT A.G.E.

Once the profile header screen is finished, you choose between an A.G.E. Mill and an A.G.E. Arc to define the shape.

Where:

A.G.E. MILL: A straight line from one X Y point to another.

A.G.E. ARC: Any part of a circle.

END A.G.E.: Ends the A.G.E. programming for the Irregular Pocket or Irregular Profile.

ABORT A.G.E.: Aborts all A.G.E. events. The data for all the events is lost.

9.2 A.G.E. Mill Prompts

Press the A.G.E. Mill key.

PROG	P/N 0			INCH
EVENT 2	IRR PCKT			EVENT 3 A.G.E. MILL Not OK
X BEGIN	2.0000	abs		TANGENT
Y BEGIN	3.0000	abs		X END
Z RAPID	2.0000	abs		Y END
Z END	1.0000	abs		CONRAD
# PASSES	1			ANGLE END
ENTRY MODE	PLUNGE			LENGTH
FIN CUT	0.0000			LINE ANGLE
RPM	2000.00			
Z FEEDRATE	25.0			
XYZ FEEDRATE	30.0			
TOOL #	2			
X END : █				
		DATA	INSERT	DELETE
		BOTTOM	EVENT	EVENT
				GUESS

A.G.E. Mill prompts. Enter what you know, skip or guess the ones you don't.

Prompts in A.G.E. Mill programming:

TANGENT: this refers to the tangency of the mill to the previous event. See Section 9.11 for a discussion of tangency.

X END: is the X dimension to the end of the mill cut; incremental is X Begin

Y END: is the Y dimension to the end of the mill cut; incremental is Y Begin

CONRAD: is the dimension of a tangential radius to the next event

ANGLE END: is the angle measured counterclockwise from this mill event to the next.

Do not input if the next event is an arc

LENGTH: is the length of the mill from beginning to end

LINE ANGLE: is the angle of this mill line (moving from begin to end) measured counterclockwise from the positive X axis (that is 3 o'clock)

GUESS: This softkey will appear when the prompt is on X or Y dimensioned data. Press the Guess key before you press INC SET or ABS SET to enter the data as a guess. See Section 9.7 for using Guess and Section 9.8 for using the Graphics to enter a Guess.

9.3 A.G.E. Arc Prompts

Press the A.G.E. ARC key.

Prompts in A.G.E. Arc programming:

TANGENT: this refers to the tangency of the mill to the previous event. See Section 9.11 for a discussion of tangency.

DIRECTION: is the clockwise (input 1), or counterclockwise (input 2) direction of the arc

X END: is the X dimension to the end of the arc cut; incremental is from X Begin

Y END: is the Y dimension to the end of the arc cut; incremental is from Y Begin

X CENTER: is the X dimension to the center of the arc; incremental is from X End

Y CENTER: is the Y dimension to the center of the arc; incremental is from Y End

CONRAD: is the dimension of a tangential radius to the next event

RADIUS: is the radius of the arc

CHORD LENGTH: is the straight line distance from the begin point to the end point

CHORD ANGLE: is the angle spanned by the arc

In addition to the normal Softkeys, this additional one will appear in A.G.E. Arc programming:

GUESS: this softkey will appear when the prompt is on X or Y dimensioned data. Press the Guess key before you press INC SET or ABS SET to enter the data as a guess. See Section 9.7

9.4 Skipping Over Prompts

In the A.G.E., events don't have to be fully defined before you can go to the next one.

You can skip the data you don't know by using the cursor hard keys on the Program Panel. After you press the arrow down key at the last prompt, the event will move to the left side of the screen and the Select Event screen will appear.

When skipping over prompts or editing, always use the cursor keys. Using INC SET or ABS SET will change the data.

If you want the event back on the right side, use the left hard key.

9.5 The OK/NOT OK Flag

Each A.G.E. event has a flag that tells you if it has been fully defined. Sometimes data from later events is needed to define previous events. To the immediate right of the event

type, the words OK or NOT OK appear, depending on whether that particular event is defined.

Once the OK flag appears for the event, you do not need to enter more information. Skip past the rest of the prompts with the down cursor hard key.

If you leave the Program Mode and then return, pressing the GO TO END softkey will take you automatically to the first NOT OK event.

9.6 Ending A.G.E.

Any time all the events are of an Irregular Profile are OK, the A.G.E. may be ended. If you are programming an Irregular Pocket, there is an additional requirement that must be satisfied before the A.G.E. may be ended: the X and Y end point of the last event must be the same as the X and Y beginning point, so that the pocket is closed.

Otherwise, the ProtoTRAK PMX CNC cannot program the tool path to clear the pocket. The Irregular Profile has no such restriction since profiles may be open or closed.

Once the A.G.E. is ended, the Irregular Pocket or Irregular Profile event is complete and you may then choose from all the programming canned cycles from the Select an Event screen. To reopen the A.G.E. Profile or Pocket, simply use the left cursor hard key to position on of the A.G.E. events on the right side of the screen. You may edit or insert other events.

9.7 Guessing Data

Whenever you are missing X or Y Ends or Centers, you should generally enter a guess. Guessed data is treated differently by the ProtoTRAK PMX CNC than regular data. Often, the information you put into the system will allow it to calculate a mathematically correct line or arc that would satisfy the conditions of the hard data you entered. This line or arc may yield more than one solution to particular point you are looking for. That is where the Guess comes in: the A.G.E. uses the guess to choose from the mathematically possible solutions. In most cases, your guesses do not have to be very precise. The smaller the lines or arcs, the more precise the guess should be.

PROG	P/N 0			INCH
EVENT 2		IRR PCKT		
X BEGIN	2.0000	abs		
Y BEGIN	3.0000	abs		
Z RAPID	2.0000	abs		
Z END	1.0000	abs		
# PASSES	1			
ENTRY MODE	PLUNGE			
FIN CUT	0.0000			
RPM	2000.00			
Z FEEDRATE	25.0			
XYZ FEEDRATE	30.0			
TOOL #	2			
			EVENT 3	A.G.E. ARC Not OK
			TANGENT	YES
			DIRECTION	CW
			X END	G 2.6000 abs
			Y END	
			X CENTER	
			Y CENTER	
			CONRAD	
			RADIUS	
			CHORD LENGTH	
			CHORD ANGLE	
Y END : 				
			DATA BOTTOM	INSERT EVENT
			DELETE EVENT	GUESS

The X End dimension has been entered as a guess - note the letter G

Guesses should always be entered as absolute dimensions. Once entered, the guessed data will have a 'G' next to it. Guessed data will be labeled this way in all the events that are flagged NOT OK. Once an event is OK, the guessed data will be replaced by calculated data. If you wish to edit your guesses, placing it on the right side of the screen will cause your original guessed data to reappear.

You can enter a combination of guessed and non-guessed data. For example, if you were to enter the dimension for X End without guessing, you would still be able to enter the dimension of Y End using guess.

9.8 LOOK and Guess

Guessed data may be entered by pressing the number keys and then SET. However, you may find it more convenient to use the LOOK graphics to enter guesses. When prompted to enter a guess you can press LOOK to go to a special version of the LOOK graphics. Using the cursor keys, you may move a point around the screen. When you come to the place where your point is, use the Enter softg key.

Your guess entries are loaded into the program when you exit the LOOK screen by pressing LOOK again. The ProtoTRAK will use the last ENTER key press and load that into the program.

When you use the graphics to guess dimensions on arcs, you may load in guesses for both the X/Y End and the X/Y Center before leaving the LOOK screen.

When you have not first pressed the Guess key, pressing LOOK gives you the same screen as in regular programming. Whether you enter the guesses as key presses or by using the graphics, the drawing of the LOOK screen distinguishes between events that are fully defined and those that rely on guessed data. OK events are represented by solid lines. NOT OK events are represented by dashed lines.

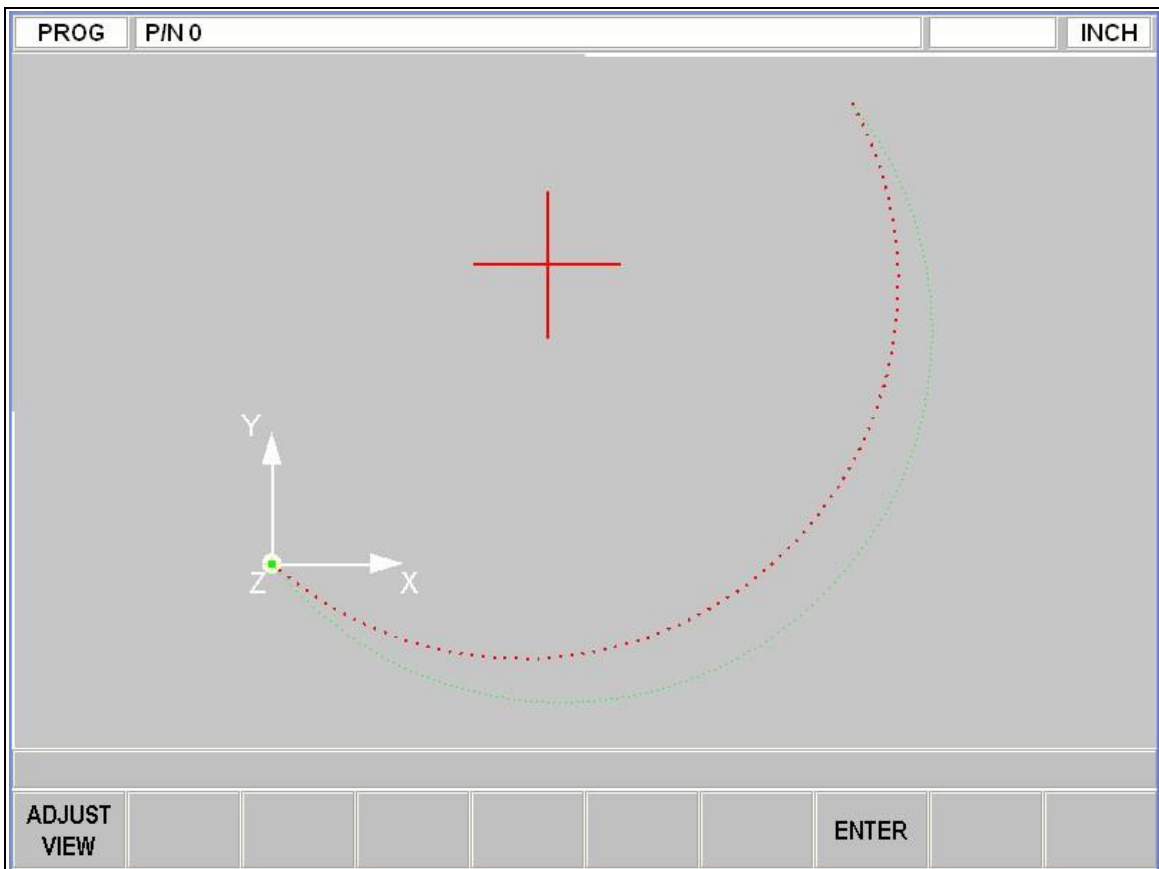

9.9 Calculated Data

Prompts that are skipped or for which guesses are entered may be replaced by data calculated by the ProtoTRAK PMX CNC. Calculated data is shown in red in order to distinguish it from the data that you entered. You cannot edit calculated data, but you may edit your original input. By putting the event with the calculated data on the right side of the screen, you may position the cursor to the prompt and re-input the data.

9.10 Arcs and Conrads

If the print is missing a lot of data, it may be desirable to program arcs as separate events where possible. If you know the center and radius of an arc, program it as an arc rather than using the Conrad. This gives the system more information to work with in figuring out other missing points.

9.11 Tangency

Tangency can occur between a mill and arc or an arc and arc. Specifically it means that the two events share one and only one point. You would answer yes to the TANGENCY prompt if the event you are programming is tangent to the previous event. The information that events are tangent helps the Auto Geometry Engine calculate other dimensions.

You can often tell by looking at the print if events are tangent: tangent intersections tend to blend smoothly, without a sharp corner.

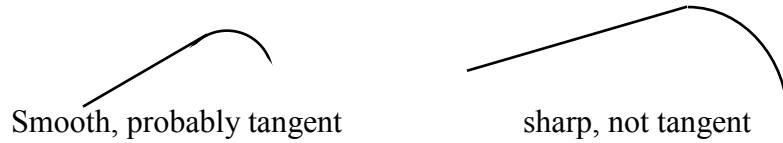

For the A.G.E., the tangent mill or arc is assumed to continue in the same direction, and not double back on the previous event:



10.0 Edit Mode

Within Program Mode, you can recall and re-input specific data prompt by prompt. The changes you make in the Edit Mode affect only the program in current memory. In order to preserve the changes for future use, the program must be stored again under the same name in the Program In/Out Mode.

10.1 Delete Events

To delete a group of events in the program, press DELETE EVENTS.

The Data Input Line will prompt for the first event to be deleted. Input the event number of the first event and press SET. Next the Data Input Line will prompt for the last event number to be deleted. Put in the last number and press SET. The remaining events will be renumbered.

10.2 Spreadsheet Editing

Spreadsheet Editing allows you to view program inputs in a table and make global changes to the program. This is particularly useful if you are working with a large program and you need to make a change to many events.

When you press the SEARCH EDIT softkey, the screen will load a table that contains data for every event.

EDIT							MP/N 15621 Master : 15621 op 1	INCH
EVT#	TYPE	TOOL#	RPM	FIN RPM	Z FEED	FIN FEED	Z RAPID	
1	AUX							
2	IRR PROFILE	1 (3.0000)	4000.00	4000.00	200.0	25.0	3.9000 abs	
3	A.G.E. MILL							
4	IRR PROFILE	1 (3.0000)	8000.00	4000.00	200.0	25.0	3.7200 abs	
5	A.G.E. MILL							
6	CIRC PROFILE	2 (0.7500)	3000.00	5000.00	15.0	100.0	3.0000 abs	
7	CIRC PROFILE	2 (0.7500)	3000.00	5000.00	15.0	100.0	3.0000 abs	
8	MILL	3 (0.7500)	6000.00		50.0		2.9000 abs	
9	MILL	3 (0.7500)	6000.00		50.0		3.0000 abs	
10	MILL	3 (0.7500)	6000.00		50.0		0.0000 inc	
11	MILL	3 (0.7500)	6000.00		50.0		0.0000 inc	
12	MILL	3 (0.7500)	6000.00		50.0		0.0000 inc	
13	MILL	3 (0.7500)	6000.00		50.0		0.0000 inc	
14	MILL	3 (0.7500)	6000.00		50.0		0.0000 inc	
15	MILL	3 (0.7500)	6000.00		50.0		0.0000 inc	
16	DRILL	4 (0.3750)	8000.00		50.0		3.7000 abs	
17	DRILL	4 (0.3750)	8000.00		50.0		0.0000 inc	
18	DRILL	4 (0.3750)	8000.00		50.0		0.0000 inc	
?					Z FEEDRATE : 50.0			
PAGE FWD	PAGE BACK				SORT	CHANGE ALL		

The Search Edit softkey launches Spreadsheet Editing. View the entire program by the variables you select.

The first time the screen appears, the data is sorted by event number. Each row represents the data for the event number shown in the first column on the left. The event number is always displayed in the first column, but the other data displayed on the table can be changed.

Soft Keys in Search Edit:

PAGE FWD: pages forward through the table.

PAGE BACK: pages backwards through the table.

SORT: enables you to change the sort to any of the data displayed. See Section 10.2.2

CHANGE ALL: enables you to make global changes of data. See 10.2.3

Arrow Buttons on Program Panel:

The 4 arrow buttons on the program panel allow you to cursor throughout the spreadsheet and highlight the data you want to edit. Only data that is highlighted and appears in the Data Input Line may be edited. Note: the EVT# (event number) and (event) TYPE may not be edited in Search Edit so the highlighter will not go there.

10.2.1 Selecting Data to be Displayed on the Search Edit Table

In order to change the data selected in the table, press the HELP hard key. There will be a listing of all the data types that may be edited in Search Edit. Press the RETURN soft key and the table will be reloaded with the data that you selected.

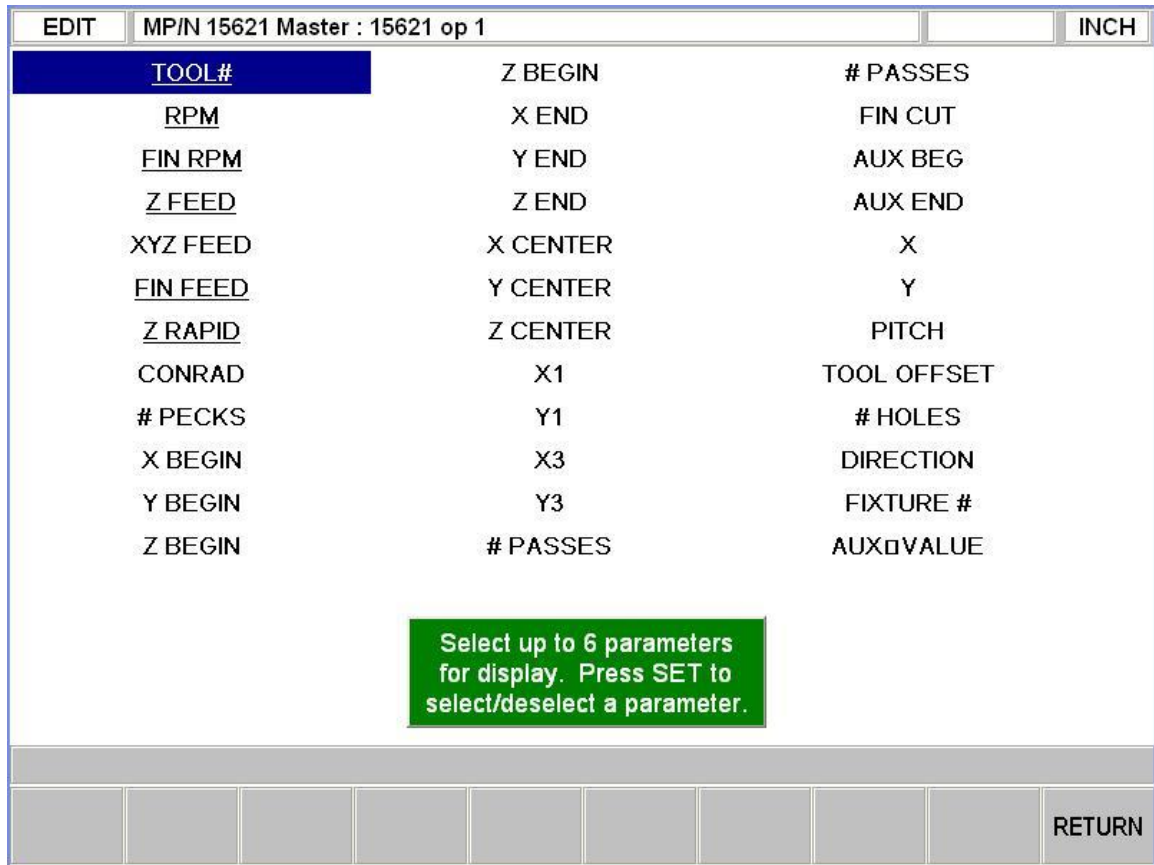

Pressing Help while viewing the spreadsheet lets you change the program parameters.

After you press the HELP hard key, the screen will display all the different parameters that can be displayed on the spreadsheet. To either select or deselect any parameter, simply highlight that parameter and press SET. When you are finished, press the Return softkey and return to the spreadsheet.

10.2.2 Sorting Data

Data may be sorted by any of the data types displayed in the column head. Red letters show which column is used for sorting the data.

To change the sort, press the SORT softkey, then select the type of data you want to use for sorting from the softkeys.

The table will be changed to sort the data in ascending order (the smallest value first, the largest last).

10.2.3 Making Global Changes to Data

Sometimes it is useful to be able to change data in a program without having to go through each event one at a time. For example, if you were to want to change the tool number for every milling event, it may be a chore to go through each event in a long program to make the changes on that event type.

In order to make global changes:

1. Sort the data in a way that groups together the things you want to change.
2. Highlight the data value that is highest on the table (nearest to the top) that you want changed.
3. Press the CHANGE ALL softkey. All the inputs that are the same as the one you highlighted and are listed together below the data you highlighted will then be highlighted.
4. Enter the new value, then press set. All the highlighted data will be changed to the value you just input.

Example:

From the screen shown in 10.2, we will change the Z Feed for each of the mill events in the program.

1. Sort by event type to get all the Mill events together.
2. Highlight the Z Feed in the first Mill event (Event # 8).

EDIT		MP/N 15621 Master : 15621 op 1					INCH	
EVT#	TYPE	TOOL#	RPM	FIN RPM	Z FEED	FIN FEED	Z RAPID	
29	DRILL	7 (0.1490)	8000.00		50.0		2.9000 abs	
30	DRILL	7 (0.1490)	8000.00		50.0		0.0000 inc	
31	DRILL	7 (0.1490)	8000.00		50.0		0.0000 inc	
20	BOLT HOLE	4 (0.3750)	8000.00		50.0		2.4500 abs	
28	BOLT HOLE	6 (0.3120)	5000.00		20.0		2.4500 abs	
8	MILL	3 (0.7500)	6000.00		50.0		2.9000 abs	
9	MILL	3 (0.7500)	6000.00		50.0		3.0000 abs	
10	MILL	3 (0.7500)	6000.00		50.0		0.0000 inc	
11	MILL	3 (0.7500)	6000.00		50.0		0.0000 inc	
12	MILL	3 (0.7500)	6000.00		50.0		0.0000 inc	
13	MILL	3 (0.7500)	6000.00		50.0		0.0000 inc	
14	MILL	3 (0.7500)	6000.00		50.0		0.0000 inc	
15	MILL	3 (0.7500)	6000.00		50.0		0.0000 inc	
6	CIRC PROFILE	2 (0.7500)	3000.00	5000.00	15.0	100.0	3.0000 abs	
7	CIRC PROFILE	2 (0.7500)	3000.00	5000.00	15.0	100.0	3.0000 abs	
2	IRR PROFILE	1 (3.0000)	4000.00	4000.00	200.0	25.0	3.9000 abs	
4	IRR PROFILE	1 (3.0000)	8000.00	4000.00	200.0	25.0	3.7200 abs	
?	A G E MILL							
					Z FEEDRATE :	50.0		
PAGE FWD	PAGE BACK				SORT	CHANGE ALL		

After sorting by Event Type, the highlighter is placed on the Z feed of the first Mill Event

3. Press the CHANGE ALL softkey. All the Z Feeds in the Mill events are highlighted.

EDIT		MP/N 15621 Master : 15621 op 1						INCH
EVT#	TYPE	TOOL#	RPM	FIN RPM	Z FEED	FIN FEED	Z RAPID	
29	DRILL	7 (0.1490)	8000.00		50.0		2.9000 abs	
30	DRILL	7 (0.1490)	8000.00		50.0		0.0000 inc	
31	DRILL	7 (0.1490)	8000.00		50.0		0.0000 inc	
20	BOLT HOLE	4 (0.3750)	8000.00		50.0		2.4500 abs	
28	BOLT HOLE	6 (0.3120)	5000.00		20.0		2.4500 abs	
8	MILL	3 (0.7500)	6000.00		50.0		2.9000 abs	
9	MILL	3 (0.7500)	6000.00		50.0		3.0000 abs	
10	MILL	3 (0.7500)	6000.00		50.0		0.0000 inc	
11	MILL	3 (0.7500)	6000.00		50.0		0.0000 inc	
12	MILL	3 (0.7500)	6000.00		50.0		0.0000 inc	
13	MILL	3 (0.7500)	6000.00		50.0		0.0000 inc	
14	MILL	3 (0.7500)	6000.00		50.0		0.0000 inc	
15	MILL	3 (0.7500)	6000.00		50.0		0.0000 inc	
6	CIRC PROFILE	2 (0.7500)	3000.00	5000.00	15.0	100.0	3.0000 abs	
7	CIRC PROFILE	2 (0.7500)	3000.00	5000.00	15.0	100.0	3.0000 abs	
2	IRR PROFILE	1 (3.0000)	4000.00	4000.00	200.0	25.0	3.9000 abs	
4	IRR PROFILE	1 (3.0000)	8000.00	4000.00	200.0	25.0	3.7200 abs	
2	A C E MILL							
					Z FEEDRATE :	50.0		
							RETURN	

Pressing the Change All softkey highlights the Z feed for all the Mill events.

4. Type in the new Z Feed value and press INC SET or ABS SET.

EDIT		MP/N 15621 Master : 15621 op 1					INCH	
EVT#	TYPE	TOOL#	RPM	FIN RPM	Z FEED	FIN FEED	Z RAPID	
29	DRILL	7 (0.1490)	8000.00		50.0		2.9000 abs	
30	DRILL	7 (0.1490)	8000.00		50.0		0.0000 inc	
31	DRILL	7 (0.1490)	8000.00		50.0		0.0000 inc	
20	BOLT HOLE	4 (0.3750)	8000.00		50.0		2.4500 abs	
28	BOLT HOLE	6 (0.3120)	5000.00		20.0		2.4500 abs	
8	MILL	3 (0.7500)	6000.00		40.0		2.9000 abs	
9	MILL	3 (0.7500)	6000.00		40.0		3.0000 abs	
10	MILL	3 (0.7500)	6000.00		40.0		0.0000 inc	
11	MILL	3 (0.7500)	6000.00		40.0		0.0000 inc	
12	MILL	3 (0.7500)	6000.00		40.0		0.0000 inc	
13	MILL	3 (0.7500)	6000.00		40.0		0.0000 inc	
14	MILL	3 (0.7500)	6000.00		40.0		0.0000 inc	
15	MILL	3 (0.7500)	6000.00		40.0		0.0000 inc	
6	CIRC PROFILE	2 (0.7500)	3000.00	5000.00	15.0	100.0	3.0000 abs	
7	CIRC PROFILE	2 (0.7500)	3000.00	5000.00	15.0	100.0	3.0000 abs	
2	IRR PROFILE	1 (3.0000)	4000.00	4000.00	200.0	25.0	3.9000 abs	
4	IRR PROFILE	1 (3.0000)	8000.00	4000.00	200.0	25.0	3.7200 abs	
?	A C E MILL							
					Z FEEDRATE : 40.0			
PAGE FWD	PAGE BACK				SORT	CHANGE ALL		

Type the new Z Feed and then SET to change all the highlighted values from 50 to 40.

In this example, the Z feed is changed from 50 to 40 for all the Mill Events.

10.3 Erase Program

Use the ERASE PROG soft key to erase the program from the current memory. Erasing the program from current memory will not affect any programs that are stored.

If you have made changes to the program and wish to save this modified program, you will need to store it. See Section 14.4

10.4 Clipboard

The Clipboard feature is a way to copy events in one program in order to put them into a different program. It is a two-part process that takes place in two different Modes. First, in the Edit Mode, the desired events are copied, or placed on the Clipboard, from the source program. Then the events are inserted into the destination program in the Program Mode.

When you press the Clipboard key from the Edit Mode, you start the process that copies the events that you want to put into a different program than the one in current memory. Before you do that, you should write a program or open the program file that has the events you want to copy. This is called the source program.

Inspect the events you want to copy. Make sure that the dimensioned data uses Absolute references in the first event to be copied and in all events where it will be important. Incremental references may be used, but keep in mind where the Incremental reference will be made from. See the section on Incremental Reference Position in this manual. In addition, you may want to modify this program in order to get all the events you want together. For example, if you want to copy events 2-5 and 7-12, you may want to modify the program to delete events 1 and 6 first. That way, you can copy the all the events as they are now numbered from 1 to 10. Remember that you can modify this program just for this purpose and it will not affect the original program unless you save it with the modifications in the Program In/Out Mode.

When the source program is ready, press the CLIPBOARD softkey. A message will appear that says "Copy Events Onto Clipboard" and the Data Input Line will read "From Event". Enter the number of the first event that you want copied and press SET.

The Data Input Line will read "To Event". Enter the number of the last event you want copied and press SET.

The group of events that you have specified is now on the clipboard and will remain there until you replace it with something else by going through the same procedure. When power is turned off to the CNC the clipboard information will also be lost.

The events on the clipboard are inserted into a program in the Program Mode. See Section 8.11.

10.5 G-Code Editor

The G-Code Editor allows the edit of G-Code programs that are opened as .GCD or PTG files. Once edited, the program may be re-saved as .GCD or PTG files. ProtoTRAK Geometry-style programs may not be saved as .GCD or PTG files.

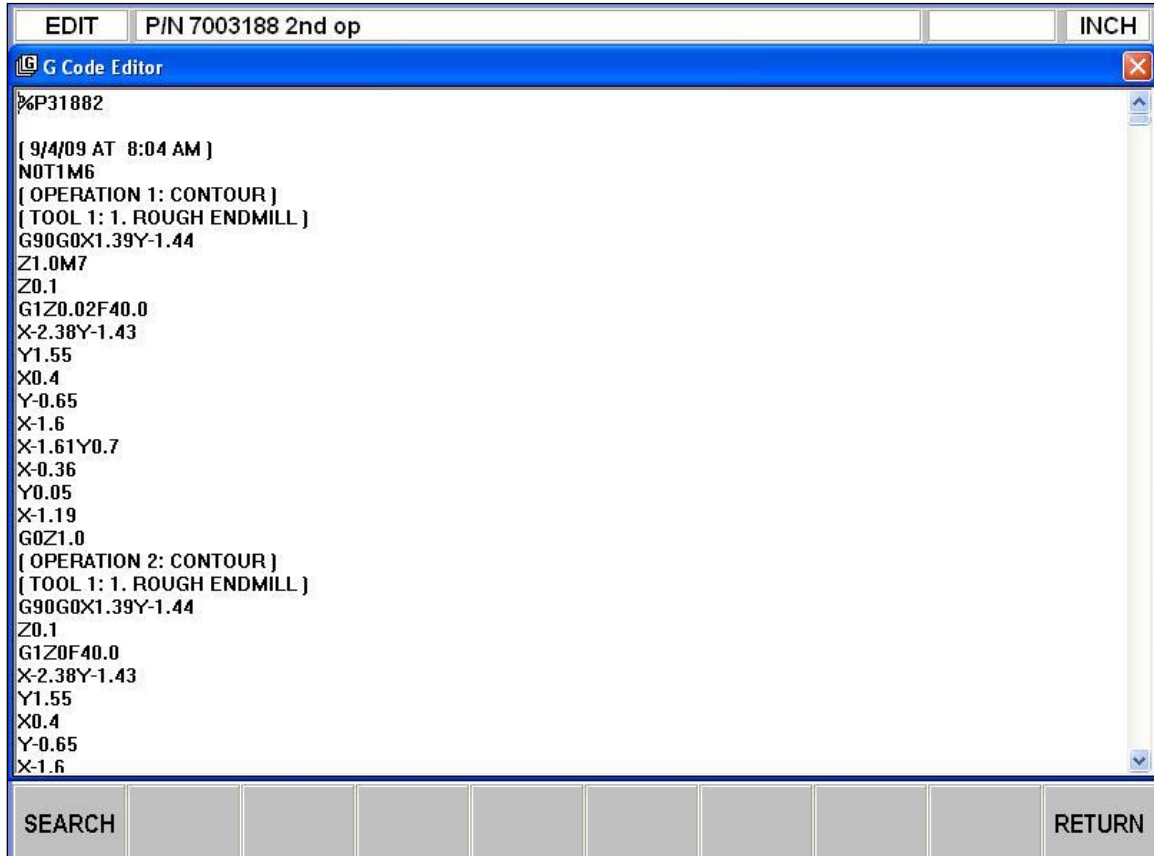

Use the G-Code Editor to modify G-Code programs.

You must connect a mouse and keyboard in order to use the G-Code Editor.

When you enter the G-Code Editor, the G-Code program is displayed starting at the first Block Number. Use the scroll bar to move up and down through the program. Use the mouse and keyboard to edit like you would an MS Notepad™ file.

Search allows you to launch a simple find-and-replace routine to aid in editing large G-Code files.

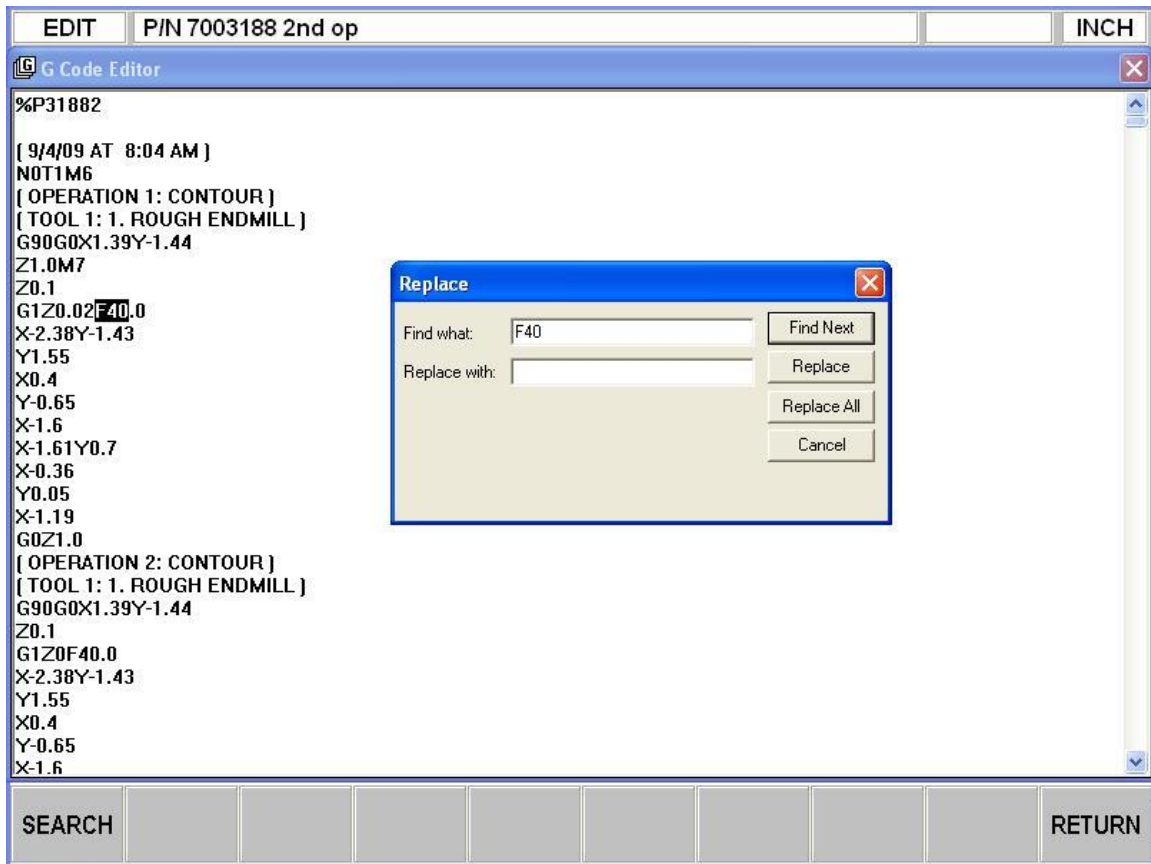

The find and replace routine.

Click in the FIND WHAT box and enter the item you want to find. Click on THE FIND NEXT box and the G-Code Editor will locate the next occurrence of that item.

Successive clicks on Find Next will continue to search through the program. Use Match Whole Word to limit the search to the entire word. For example, if you want to find G2, but not G20 or G22, select Match Whole Word Only.

Instead of typing the item into the Find What box, you may simply highlight an item on the G-Code Editor screen. That item will be entered into the Find What box for you.

To make changes to Find What items, type what you want to have into the Replace With box. You can replace items one at a time by clicking first the FIND NEXT box then the REPLACE WITH box for as many changes as you want to make. You can replace every item in the program with a single click of the REPLACE ALL box.

Return closes the G-Code Editor and returns the screen to the Edit Mode.

Note: If you use the USB Thumb Drive to store a G-code (.gcd) program file, you must leave the Thumb Drive plugged into the USB port the entire time the program is in current memory. If you unplug the thumb drive with the program still in current memory, the ProtoTRAK will display an error message.

Any change made in the editor will be applied the next time you run the program. To permanently save these changes, go to PROG IN/OUT screen and use the save feature.

10.6 Update GCD

The UPDATE GCD button will show up when a .PTG file is loaded into memory. This feature allows you to update the G code file that is linked within the .PTG file. This is useful when you go back to your offline computer and update your G code file and then want to re-insert it into your .PTG file.

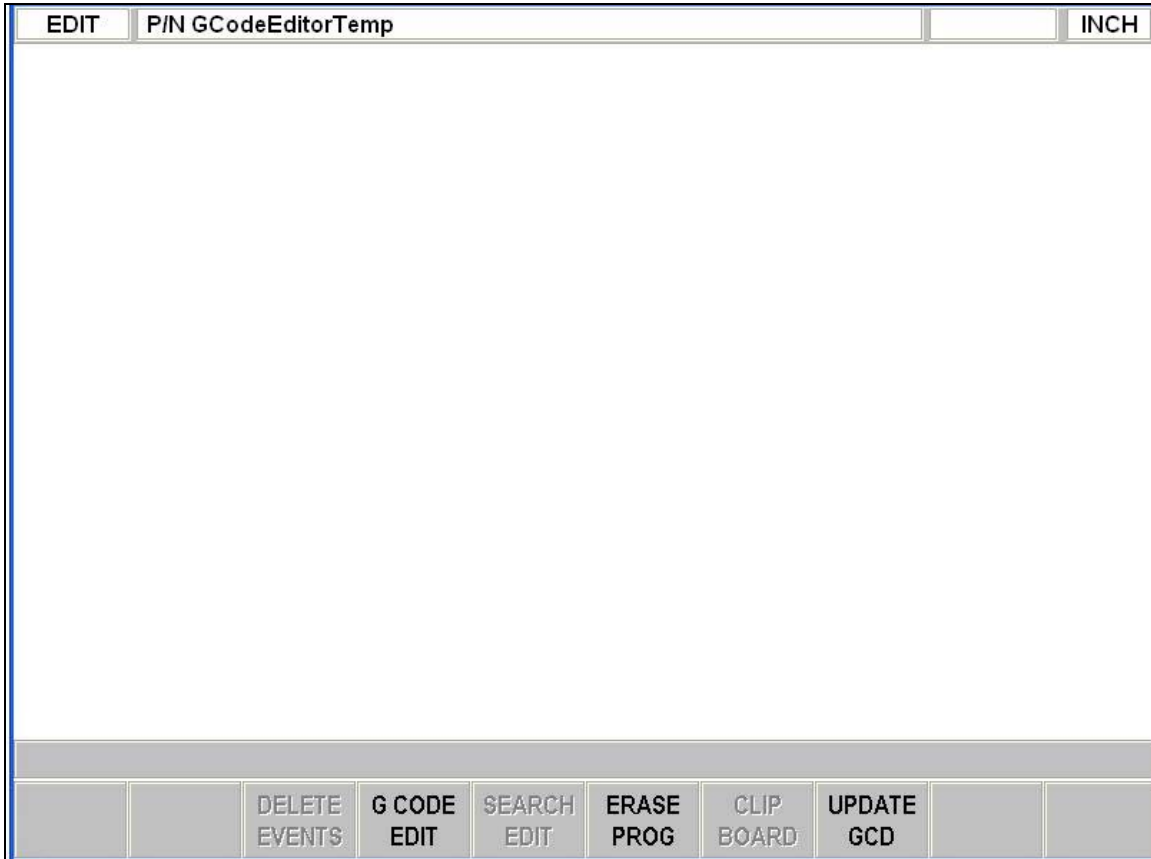

If you load just a .GCD file into memory, then this button will be grayed out until you save the program as a .PTG file. A .PTG file is created when you save a G code file with notes and pictures.

When using UPDATE GCD, you must first remove the link to the G code file that is in your .PTG file. To do so, press the TAB softkey and highlight the file in question and then press REMOVE ITEM as shown in the figure below.

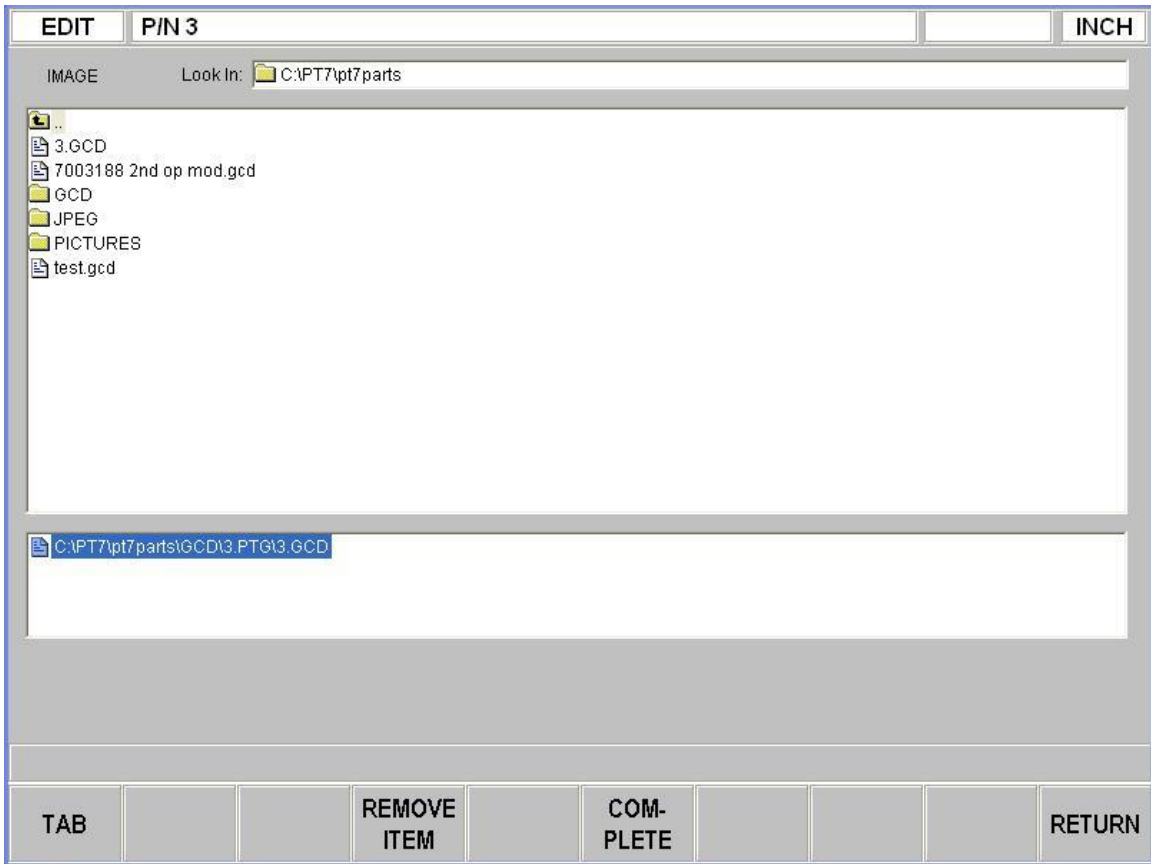

Once this is done, press TAB and go to the directory where the new file resides. Highlight the new file, press SELECT and then COMPLETE. The new G code file will now be linked to your .PTG file. Now go and resave your program.

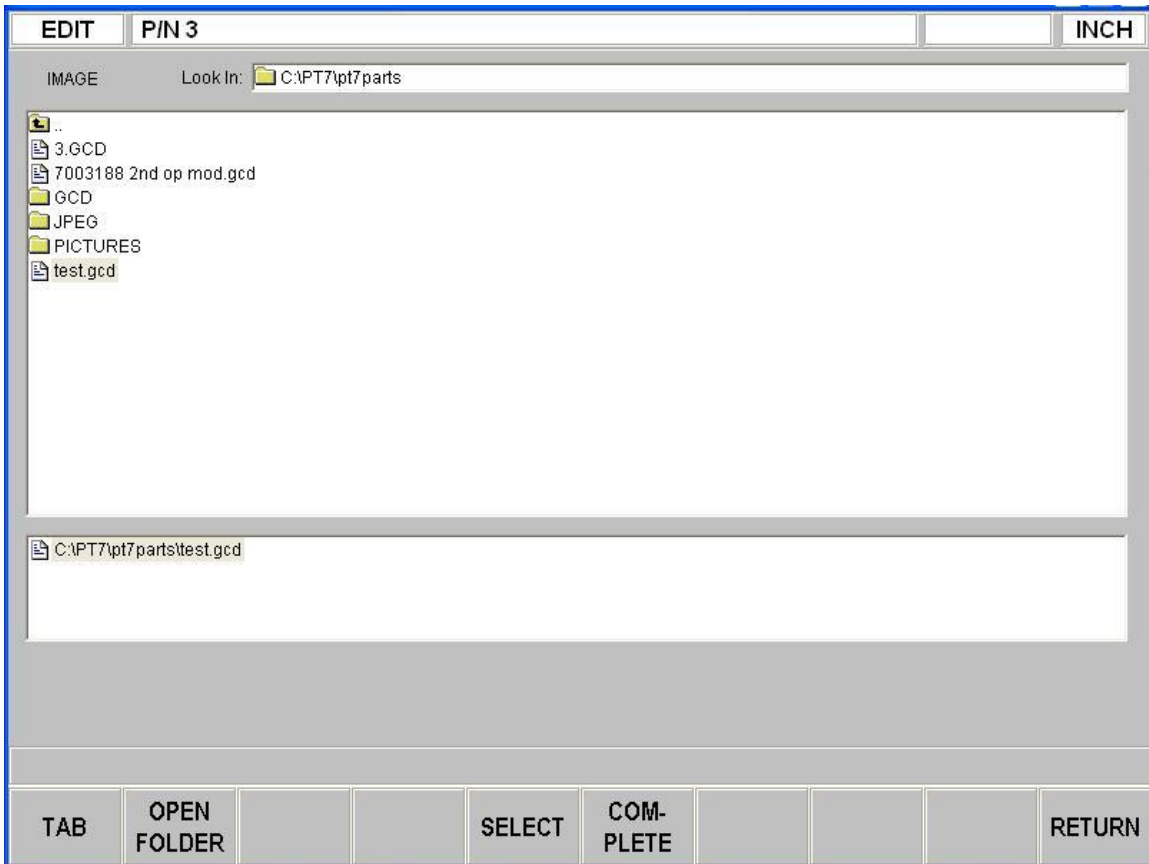

10.7 Next Program

The NEXT PROG button shows up in edit mode when you open a master program. It allows the user to select which program they would like to view when performing any of the editing functions. When this button is pressed, the program name up in the status line will change to show which program will now be edited.

11.0 Program Set Up Mode

The Program Set Up Mode lets you do the set up steps that do not involve the machine. You can do these steps while the machine is running another job. Move between the Current and Staged view by pressing the C/S button on the upper left side of the Program Panel.

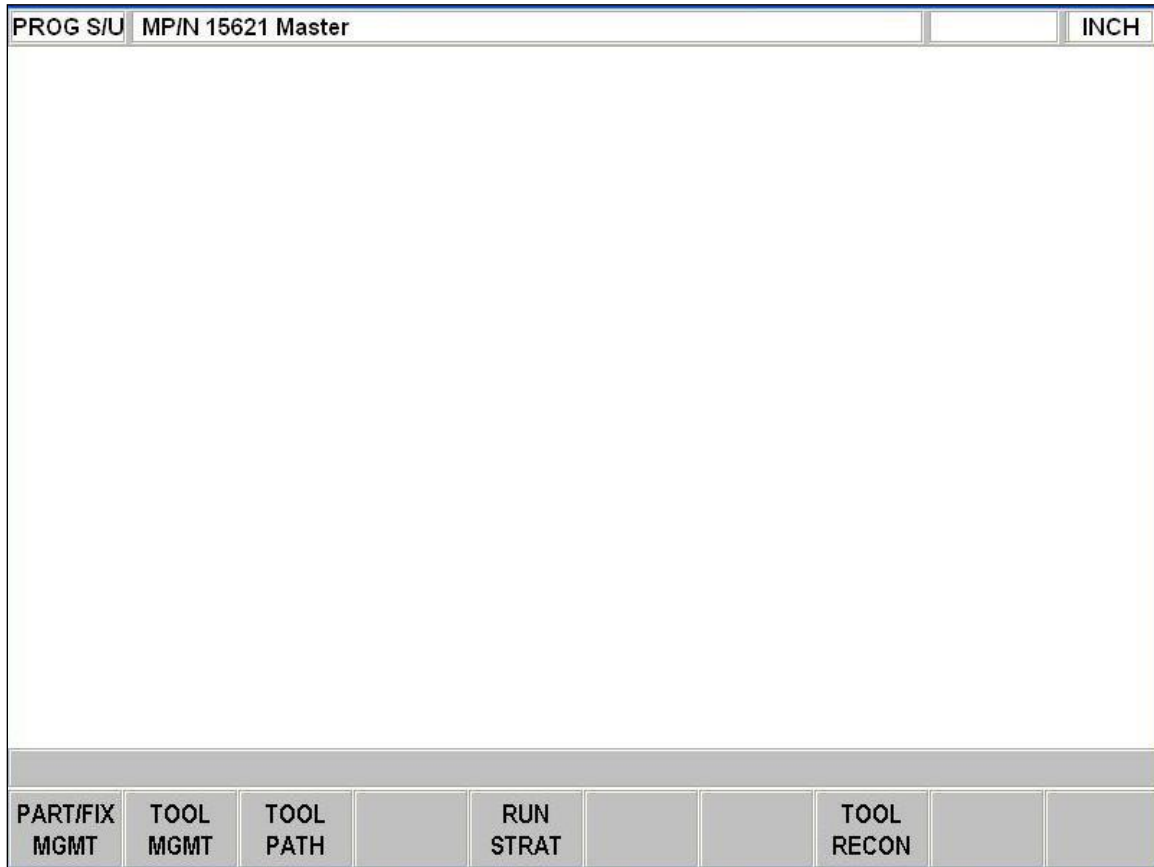

Program Set Up

11.1 Part/Fixture Management

This is where you set the ball lock location for where you want to run your part(s) and also where you set your part zero locations relative to the ball lock location.

PROG S/U	MP/N 15621 Master					INCH
ATC Pos 0			No Tool			
Part/Fixture Management						
Part	1	2				
P/N	15621 OP 1	15621 OP 2				
Fixture Location	A	C				
Fixture Number	1	1				
X Offset	6.0380	6.0036				
Y Offset	7.5445	7.5482				
Z Offset	1.2600	4.8800				
Parts/Fixture	1	1				
X Shift	0.0000	0.0000				
Y Shift	0.0000	0.0000				
Z Shift	0.0000	0.0000				

X	0.0000	A
Y	0.0000	A
Z	15.7340	A

1, SET for Fixture A
 2, SET for Fixture B
 3, SET for Fixture C

FIXTURE LOCATION : A					
PICTURE	NOTES	GO TO	Z SAFETY	SPIN SPEED	RETURN

Part/Fixture Management

Part – displays the number of parts in your program. If you are running a master program, you can have up to 4 parts in 4 columns. Single programs will only display a single program and column.

P/N – program or part number of the individual part

Fixture Location – the ball lock location for where you have placed your part.

Fixture Number – the number of the fixture you are placing at this location. This may be handy if you have multiple fixtures for the same part or operation.

X, Y and Z Offsets – the X and Y offsets are the offsets from the center of the ball lock location to your part zero. The Z offset is a measurement from the top of the table to the Z zero on your part. The small DRO in the lower left hand corner displays the distance you are away from the ball lock location you are working on. The DRO will change depending on which ball location you have chosen for each part. To measure the Z offset, call up any known tool and touch it to the Z zero on your part. Enter the Z value

you see in the small DRO in the lower left hand corner. When staging your next job, measure the distance from the bottom of your fixture plate to the part Z zero. This can be done by sitting your fixture plate on a surface plate and using a height gage.

Parts/Fixture – this tells the control how many of the same part you are running per fixture. To use this feature each part must have the same offset relative to the first part. For example, let say you are running 3 parts per fixture, the second and third part must be equally spaced in the X, Y, or Z plane (or any combination) from the first part. There is limit of 26 work coordinates per program so if you have a master program with 4 parts, you have 22 additional offsets that can be used for shifts.

X, Y and Z Shift – this is where you enter the offset or shift between each part.

11.1.1 PICTURE

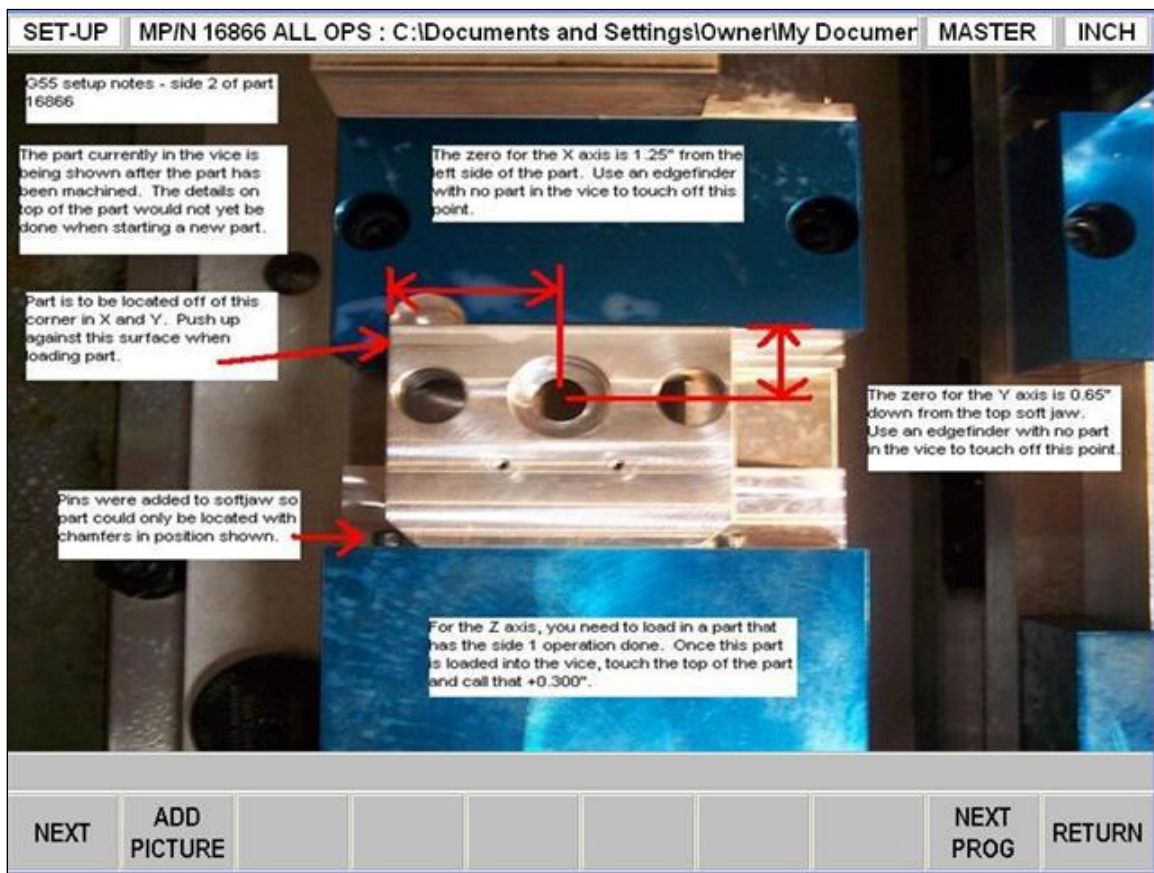

Picture

By pressing the PICTURE softkey you are able to see any pictures that have been saved with the program.

ADD PICTURE takes you to a screen that lets you select and add pictures using the same technique as navigating the Program In/Out Mode. You can save up to 8 pictures per master program and 8 pictures per regular program. So for a master program with 4

parts, you can save 8 pictures per program and 8 additional pictures within the master program for a total of 40 pictures.

NEXT allows you to view the next picture that is attached to a given part. Pressing this button allows you to toggle between each picture.

Note: Once you add pictures, you must resave the program in the Program In/Out Mode for the pictures to be saved. The pictures for each program will be saved within a folder called PICTURES and then within a folder that is given the same name as your program. This will all be saved in the directory that you save your program. The ProtoTRAK will automatically create these folders if they do not exist.

NEXT PROG – This allows you to view the pictures you have saved for each program within the master program. If you have created a master program with 4 parts, then you may need to hit this button 4 times to toggle between the pictures for each part and a 5th time to get back to where you started.

Pictures should be loaded in the ProtoTRAK as JPEG files. It should be noted that the ProtoTRAK will reduce the resolution of the picture to less than 100 Kb if the picture size is larger than this. This is done so your pictures do not take up too much drive space.

11.1.2 NOTES

PROG S/U	P/N 16866 OPERATION 1	INCH
Operation 1 for part 16866		Use 1/8 step jaws as shown in picture
Use 2 vise plates and locate in ball lock A and C		Use 3" long vise stop as shown in picture and remove before running.
See pictures for part zero		For ball lock A use vise 3 and for ball lock C use vise 4
Tool List Tool # 1 - 1/2 rough end mill 3 flute (lied about diameter, used a +0.02 diameter modifier) Tool # 2 - 1/2 finish carbide end mill 3 flute Tool # 3 - 5/8 spot drill Tool # 4 - 0.484 drill Tool # 5 - 0.406 drill Tool # 6 - 1/8 drill Tool # 7 - 6-32 roll tap Tool # 8 - 1/4 chamfer tool - called c'sink in program (lied about this tool and used a -0.2 diameter modifier) Inspect 0.518 to 0.520 depth with depth micrometers		
NOTES: Page 1 of 4		
TAB	NEXT	RETURN

A keyboard is necessary to enter text into the notes section.

TAB moves you from one section to the next. You may want each section to have the same kind of information from program to program.

NEXT it moves you through the four pages of notes available.

NEXT PROG moves you through the notes you may have for each part in a master program. Just like pictures you can have up to 5 notes sections if you are running a master program with 4 parts.

Notes are saved within the program so if you add additional notes you must save the program.

11.1.3 GO TO

GO TO allows the user to move the machine directly over the top of any of your ball lock locations.

When a ball lock location is chosen and GO is pressed, the machine will move the X and Y axis directly over the ball lock location and the Z axis will move to the tool change height. The machine will move at rapid speed. When complete, the DRO will read 0 for the X and Y axis and correspond to the ball lock location you have chosen.

11.1.4 Z SAFETY

The Z SAFETY sets a safety plane for the tool to move to when moving between fixtures or part shifts.

The value entered is measured from the top of the table. If no value is entered, the Z safety defaults to the tool change height. You must enter a Z safety value each time a program is opened. The Z safety is not saved with your program.

11.1.5 Part/Fixture Management LOOK

If you press the LOOK key on this screen, it will bring up a screen showing where your have placed your fixtures on the table.

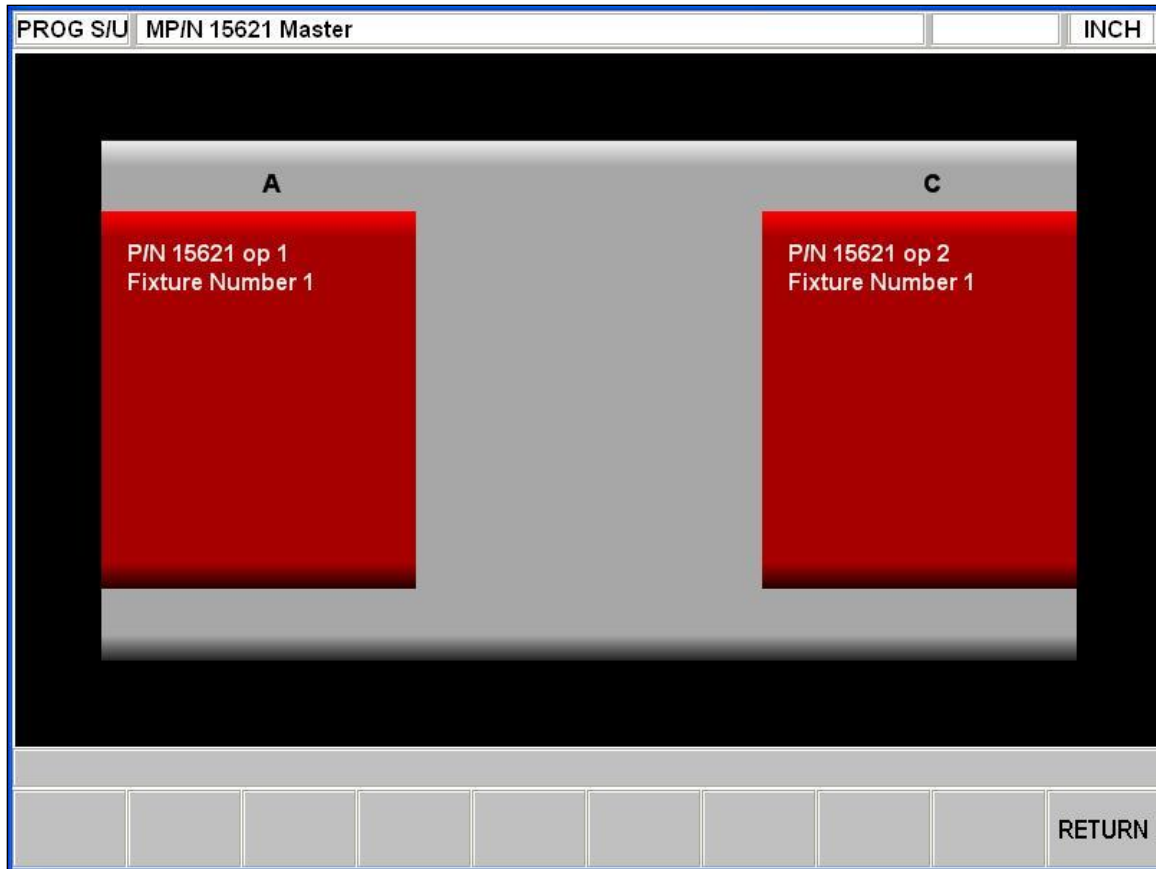

11.2 Tool Management

The Tool Management screen is where you go to assign your programmed tools to be added to or removed from the automatic tool changer (ATC).

SET-UP		MP/N 16866 ALL OPS						INCH	
ATC						PART PROGRAM TOOL TABLE			
Loc	Dia	Type	Z Offset	Z Mod	Dia Mod	Tool No	Dia	Type	ATC Loc
1	0.5000	Ruf EM	0.0000	0.0000	0.0000	1	0.5000	Ruf EM	1
2	0.5000	Fin EM	0.0000	0.0000	0.0000	2	0.5000	Fin EM	2
3	0.6250	Ctr Drill	0.0000	0.0000	0.0000	3	0.6250	Ctr Drill	3
4	0.4840	Drill	0.0000	0.0000	0.0000	4	0.4840	Drill	4
5	0.4060	Drill	0.0000	0.0000	0.0000	5	0.4060	Drill	5
6	0.0000	None	0.0000	0.0000	0.0000	6	0.3750	Ctr Drill	
7	0.0000	None	0.0000	0.0000	0.0000	7	0.1250	Drill	
8	0.0000	None	0.0000	0.0000	0.0000	8	0.1360	Tap	
9	0.0000	None	0.0000	0.0000	0.0000	9	0.2500	Cntrsink	
10	0.0000	None	0.0000	0.0000	0.0000	10	0.5200	Ruf EM	
11	0.0000	None	0.0000	0.0000	0.0000	11	0.5030	Bor Bar	
12	0.0000	None	0.0000	0.0000	0.0000	12	0.5000	Cntrsink	
13	0.0000	None	0.0000	0.0000	0.0000	13	0.5000	Cntrbore	
14	0.0000	None	0.0000	0.0000	0.0000	14	0.0700	Drill	
15	0.0000	None	0.0000	0.0000	0.0000	15	0.0850	Tap	
16	0.0000	None	0.0000	0.0000	0.0000	16	0.7480	Bor Bar	
17	0.0000	None	0.0000	0.0000	0.0000	17	0.2500	Drill	
18	0.0000	None	0.0000	0.0000	0.0000				
19	0.0000	None	0.0000	0.0000	0.0000				
20	0.0000	None	0.0000	0.0000	0.0000				
21	0.0000	None	0.0000	0.0000	0.0000				

ATC LOCATION :

TOOL CRIB	REMOVE TOOL	NOTES	DISABLE LOC						RETURN
-----------	-------------	-------	-------------	--	--	--	--	--	--------

Tool Management Screen

Lets look at the different sections and fields that make up this screen.

ATC Table

The ATC table displays all the tools that are either currently loaded in the ATC, or are assigned to be added (which is done later in the TOOL LOADING page. See Section 12.1). It also displays all manual tools currently assigned. Tool locations 17 through 24 are reserved for the use of manual tools. When a program run calls out one of these locations, the system will prompt you to manually load in the specified tool. Once the program has completed using the tool, it will once again prompt you to remove the tool from the spindle, and then continue with the rest of the program. The ATC table is saved independently from your part programs, and will save automatically when you exit the screen.

Loc – This refers to the fixed tool location on the ATC. You can have up to 16 tools loaded into the ATC at once.

Dia – The tool’s programmed diameter, carried over from the Part Program Tool Table.

Type – Tool description, carried over from the Part Program Tool Table.

Z Offset – This is the offset of the tool in relation to the machine’s Base Tool Offset, as set in service code 502.

Z Mod – A modifier used in addition to the Z offset. Use a negative modifier to cut with the tool deeper into your part, or a positive value to go higher.

Dia Mod – A modifier used in addition to the diameter of the tool. A positive modifier means the tool is larger. For example, if your tool has a ½” diameter and you enter +0.005” for the diameter modifier, the control will compensate based on a diameter of 0.505”.

You may notice that some of the tools in the ATC table are shown in different colors. Here are their meanings:

Black – this means that the description listed in the table currently matches what is physically loaded in the ATC.

Red – this indicates that the tool is assigned to be added to the ATC. Go into the TOOL LOADING page to physically add the tool. Once you physically add the tool, the text will turn black.

Blue – indicates that the tool is assigned to be added to the ATC, and came from the tool crib. Go into the TOOL LOADING page to physically add the tool.

Orange – Indicates that the tool listed will be used as a manual tool.

Part Program Tool Table

The Part Program Tool Table will display the tools from all your program(s) that are in current memory. When a program is erased, modified, or if a new program is loaded into memory, the part program tool table will update accordingly.

Tool No – This refers to the tool’s number that is assigned from PROG mode.

Dia – Enter the diameter of the tool that you plan to cut with. This will affect the tool path when compensation is applied. For more on tool compensation, see section 5.7.

Type – Brief description of what type of tool it is, so as to help differentiate it from the other tools. When this field is highlighted, you will be given a list of tool names from which to choose from.

Note: Both the Dia and Type fields for the part program tool table can be entered here, or through the tool help screen while in PROG mode. See section 8.1.

ATC Loc – Once you entered the tool type and diameter fields, then you can assign the tool to a location on the ATC. If you choose a location that is currently empty, then the tool will appear on the ATC table in red. This indicates that the tool still needs to be physically added to the ATC, which you can do in the TOOL LOADING page. See section 12.1. Otherwise, if the tool is already located in the ATC, and the type and dia fields match, then it will automatically assign that location and remain black. This indicates that nothing further needs to be done, and the tool is ready to use.

Current vs. Staged Modes

The C/S button on the program panel allows the user to toggle between what we call Current Mode and Staged Mode. The staged feature allows the user to be able to program and setup the majority of the next job while the machine is running.

Current Mode refers to the current program that you are running on the machine. Staged Mode refers to a program that you are setting up to be run after the current job is finished. When you press this button the machine toggles between these modes. You can tell you are in staged mode when the softkeys are highlighted in white versus gray.

PROG S/U		P/I/N O						INCH	
ATC						PART PROGRAM TOOL TABLE			
Loc	Dia	Type	Z Offset	Z Mod	Dia Mod	Tool No	Dia	Type	ATC Loc
1	0.0000	None	0.0000	0.0000	0.0000				
2	0.0000	None	0.0000	0.0000	0.0000				
3	0.0000	None	0.0000	0.0000	0.0000				
4	0.0000	None	0.0000	0.0000	0.0000				
5	0.0000	None	0.0000	0.0000	0.0000				
6	0.0000	None	0.0000	0.0000	0.0000				
7	0.0000	None	0.0000	0.0000	0.0000				
8	0.0000	None	0.0000	0.0000	0.0000				
9	0.0000	None	0.0000	0.0000	0.0000				
10	0.0000	None	0.0000	0.0000	0.0000				
11	0.1800	Drill	0.1000	0.0000	0.0000				
12	0.5200	Fin EM	0.5000	-0.0100	0.0000				
13	0.5000	Fin EM	0.1000	0.0000	0.0000				
14	0.5000	Ctr Drill	0.1000	0.0000	0.0000				
15	3.0000	Ctr Drill	1.0000	0.0000	0.0000				
16	0.1800	Drill	0.1000	0.0000	0.0000				
17	0.0000	None	0.0000	0.0000	0.0000				
18	0.0000	None	0.0000	0.0000	0.0000				
19	0.0000	None	0.0000	0.0000	0.0000				
20	0.0000	None	0.0000	0.0000	0.0000				
21	0.0000	None	0.0000	0.0000	0.0000				
ATC LOCATION : 									
TOOL CRIB	REMOVE TOOL	NOTES	DISABLE LOC		REFRESH TABLE				RETURN

When switching between Current and Staged Modes on the ProtoTRAK PMX, the Tool Management pages basically retain the same functions. There are a couple of points worth mentioning though:

The Part Program Tool Table will only list what is in corresponding memory. Staged Mode will display the tools from staged programs, and Current Mode will display the tools from current programs.

The ATC table in staged mode can be updated to reflect changes in current by pressing the REFRESH TABLE button. Please note that when you press this button you will lose any changes you made to the staged tool management table. The table in Current and

Staged Mode will once again be identical. For example, this may be necessary if you changed a modifier in Current Mode for a tool that you will be using on the next part.

The buttons in Staged Mode that are gray are not available to the user. This is normally the case when the feature or function requires some sort of interaction with the machine. For example, in Machine Setup Mode, the TOOL LOADING softkey is gray, since you cannot change tools in staged when you are running a program in current mode.

To transfer programs from Staged to Current, you must go back to Current Mode and go to PROG IN/OUT. Press the TRANSFER button to transfer your files. The current program you have in memory will be erased and the program from staged will now be loaded. The last thing you should have to do before running your program is load or remove your tools from the TOOL LOADING mode. Use your CHECKLIST to verify you are ready to run.

It should be noted that when you shut down the PMX control, any program in STAGED mode will be automatically saved along with any setup info that you entered. The user will then be able to restore the STAGED mode the next time you enter STAGED mode. If you press the F10 softkey as shown below, your program will be reloaded. It should be noted that you only get 1 chance to reload your program, so if you hit the START softkey, the saved STAGED program will be lost.



11.2.1 TOOL CRIB

When a tool is removed from the ATC table, you have the option of storing it in the Tool Crib Section. The Tool Crib is a separate page that will keep track of up to 100 tools that have already been previously defined. By storing it in the Tool Crib, you have the ability to quickly assign it back into the ATC along with its offset.

PROG S/U		P/N 16866 OPERATION 1			INCH
TOOL CRIB					
Dia	Type	Z Offset	Z Mod	Dia Mod	ATC Loc
0.5000	Ctr Drill	0.1000	0.0000	0.0000	
0.5000	Fin EM	0.1000	0.0000	0.0000	
0.5200	Fin EM	0.5000	-0.0100	0.0000	
ATC LOCATION :					
ADD ATC	NEW TOOL	REMOVE TOOL			
					RETURN

Tool Crib

ADD ATC: After highlighting the tool that you want to add back into the ATC table, enter an ATC location that is not currently being used into the “ATC Loc” field, and then press the ADD ATC button. This will transfer the tool from the tool crib back into the ATC table in the tool management page.

NEW TOOL: Press this button to create a new tool from scratch. You can then enter values for all the necessary fields, and then add it to the ATC table.

REMOVE TOOL: Press this button to delete a tool from the tool crib.

11.2.2 REMOVE TOOL

This button will remove the highlighted tool from the ATC side of the table. You will be prompted whether or not to store the tool into the TOOL CRIB. Select YES to move the tool into the TOOL CRIB, or select NO to permanently delete the tool. Once the tool is

removed from the table, the tool itself will be marked to be removed from the TOOL LOADING screen, so that the tool can be physically taken out of the ATC.

11.2.3 NOTES

This will take you to the notes page where there are several text boxes that allow you to enter any notes related to your tool setup or descriptions. These are the same notes that are also found on the Part / Fixture Management page. Notes are saved within each PT7, PTM or PTG program.

11.2.4 DISABLE LOC

In the event that one of the tool positions on the ATC becomes unusable (for example, due to the plastic fingers breaking off), you can use this button to disable the usage of that particular tool location. This will lock the software out from attempting to either grab a tool from this position, or putting a tool back into it.

11.3 TOOL PATH

When the TOOL PATH soft key is pressed, the program is processed and the tool path graphics are displayed.

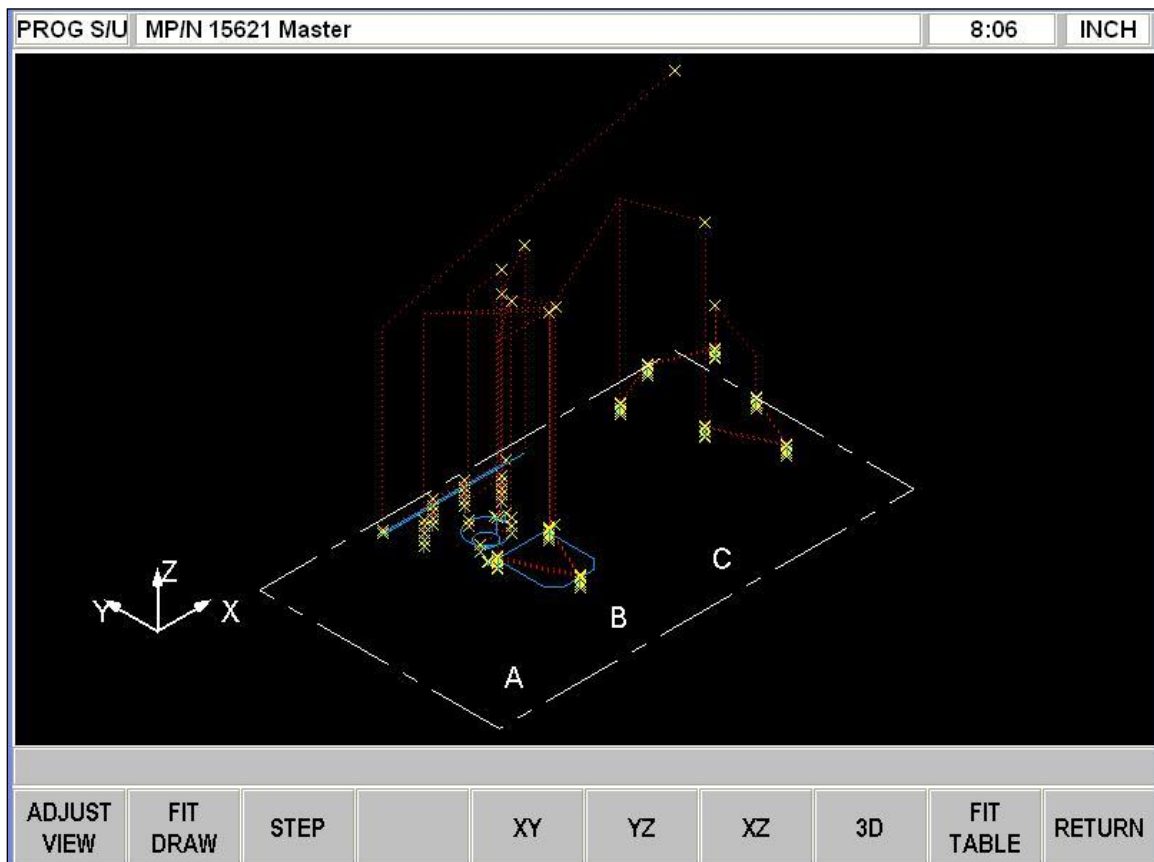

The Tool Path graphics show the program and tool positions

Most programming errors that would prevent the program from running are detected when the tool path graphics are selected. For example, if you were to have omitted a

minus sign from a Z End dimension, the system would give you an error message that the Z End should not be higher than the Z Rapid.

The displayed graphic is automatically sized to fit the screen. The path shown on the screen represents the center of the tool.

Position and drill events are drawn in yellow.

Rapid moves are in red.

Programmed geometry is in blue.

The white rectangular box that is shown on the screen represents the travel limits for the machine. If your part is shown outside of the extents, the program will not be able to run. The software will warn you when this happens.

Within the box you will also see letters A, B and C. These correspond to the ball lock locations found on your table.

In the upper right hand corner of the screen you will see a time displayed in one of the boxes. This is the run time estimate for the part you programmed. It represents the total time necessary to run the program from start to finish. When you make modifications to your program, you must press the TOOL PATH button so the control can update the time necessary to run the part. This value will then be displayed in run mode when running.

11.3.1 Softkeys in Tool Path

ADJUST VIEW: calls up additional softkeys to adjust the view. See below.

FIT DRAW: will re-draw, automatically sizing the part to fit the screen (necessary only if an adjustment changed the drawing from its initial sizing).

STEP: each press of the STEP button shows the next tool move. You may hold the STEP button down to draw the graphic without repeated button presses. To complete the drawing automatically, press FIT DRAW.

XY, YZ, XZ, 3D: shows the same drawing on the screen, with adjustments, in the view you select.

FIT TABLE: When this button is pressed, the screen will be resized to show the entire extents of the machines table.

Softkeys in ADJUST VIEW:

FIT: same as the FIT DRAW.

▼ ▲ ◀ ▶ : moves the drawing in that direction.

ZOOM IN, ZOOM OUT: resizes the drawing.

FIT TABLE: When this button is pressed, the screen will be resized to show the entire extents of the machines table.

RETURN: returns to the previous softkeys, retaining the adjustments that were made to the drawing.

11.4 Run Strategy

Run Strategy lets you direct the ProtoTRAK PMX to run your master program either Tool-by-Tool or Part-by-Part.

If you select PART by PART, the program runs the first part through to completion, then does the 2nd part through to completion and so on for parts 3 and 4.

If you select TOOL by TOOL, the program will run the 1st tool in part 1 and then look to see if tool 1 is the 1st event in part 2, if it is then it will run tool 1 on part 2, if it is not, then it will look and see if tool 1 is used in the first event in part 3 and apply the same rules. Once this is done it will then look at part 4. Once tool 1 is done, it will now run the next tool found in part 1 and apply the same rules across parts 2, 3 and 4 as it did for the 1st tool.

Note – Run strategy is applicable only when running a master program.

11.5 Tool Recon (Reconciliation)

PROG I/O	MP/N 0 : program 2	INCH
<u>Tool Number Reconciliation</u>		
<u>P/N PROGRAM 1</u>	<u>P/N PROGRAM 2</u>	<u>Rec</u>
0.500 Ctr Drill 1	3.000 Face Mill 4	▶ 4
0.500 Ruf EM 2	0.750 Fin EM 1	▶ 7
0.750 Fin EM 3	0.500 Ctr Drill 2	▶ 8
0.250 Drill 5	0.375 Drill 3	▶ 9
	0.250 Fin EM 6	▶ 6
ENTER NEW TOOL NUMBER : 4		
		SAVE RETURN

Tool Reconciliation

Tool Reconciliation is the process of renumbering like tools to the same tool number within different part programs in your master program. For example, in the table above, program 1 and 2 both use a 0.500 Ctr Drill but in program 1 the tool is called tool # 1 and in program 2 it is called tool # 2. This means we need to rename the tool in program 2 to tool # 1. Once you change the tool number so it is the same in all programs and hit the SAVE button, the programs in program mode will be automatically updated to reflect this tool number change. The figure below shows the tool tables after they have been reconciled.

PROG S/U		MP/N 0				INCH	
<u>Tool Number Reconciliation</u>							
<u>P/N PROGRAM 1</u>		<u>P/N PROGRAM 2</u>		<u>Rec</u>			
0.500 Ctr Drill	1	3.000 Face Mill	4	▶	4		
0.500 Ruf EM	2	0.750 Fin EM	3	▶	3		
0.750 Fin EM	3	0.500 Ctr Drill	1	▶	1		
0.250 Drill	5	0.375 Drill	9	▶	9		
		0.250 Fin EM	6	▶	6		
ENTER NEW TOOL NUMBER : 4							
						SAVE	RETURN

The control will reconcile your tools only the 1st time you enter this mode. The 2nd time you enter this mode, the column labeled Rec will show the same numbers that are found on the column to the left of the it. You still have the ability to rename each tool if you wish. Once this is done, hit the SAVE button.

Notes - Tool Reconciliation is applicable only when running a master program.

12.0 Machine Set Up Mode

In Machine Set Up Mode you do the set up that must be done with the machine stopped and the door open. This part also includes the Checklist for easy reference to the steps you must complete to machine your job correctly.

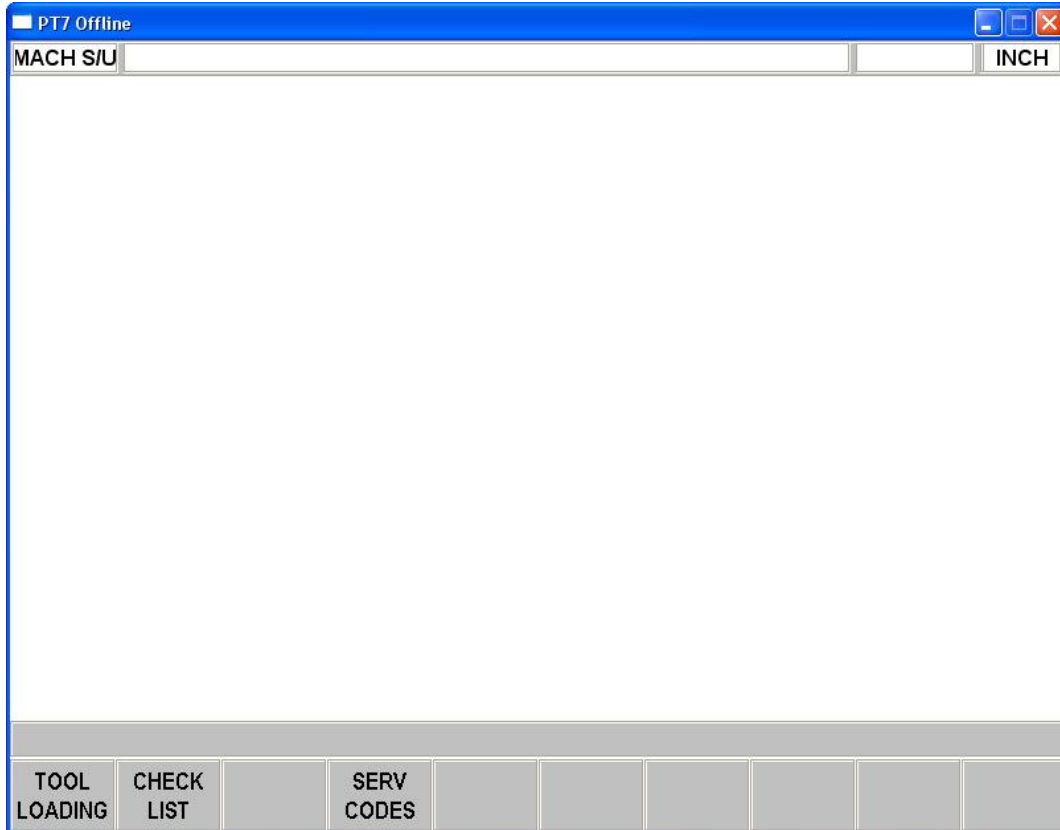

Machine Set Up Screen

12.1 Tool Loading

MACH S/U		MP/N 15973 Master					INCH	
ATC Pos 1		Loc 1		Dia 0.5500		Drill		
ATC								
ATC Loc	Tool #	Dia	Type	Z Offset	Z Mod	Dia Mod	Action	
1		0.5500	Drill	0.1270	0.0000	0.0000		
2		0.5000	Ctr Drill	2.0000	0.0000	0.0000		
3		0.6500	Drill	3.0000	0.0000	0.0000		
4		0.2010	Drill	4.0000	0.0000	0.0000		
5		3.0000	Face Mill	1.0000	0.0000	0.0000		
6		0.7500	Fin EM	1.0000	0.0000	0.0000		
7		0.7500	Face Mill	1.0000	0.0000	0.0000		
8		0.3750	Ctr Drill	1.0000	0.0000	0.0000		
9		0.5000	Drill	1.0000	0.0000	0.0000		
10		0.3120	Drill	1.0000	0.0000	0.0000		
11		0.1490	Drill	1.0000	0.0000	0.0000	Remove	
11	1	1.5000	Face Mill	0.0000	0.0000	0.0000	Add	
12		0.1600	Tap	1.0000	0.0000	0.0000	Remove	
12	2	0.2810	Ctrbore	0.0000	0.0000	0.0000	Add	
13	3	0.7500	Fin EM	0.0000	0.0000	0.0000	Add	
14		0.0000	None	0.0000	0.0000	0.0000		
15		0.0000	None	0.0000	0.0000	0.0000		
16		0.0000	None	0.0000	0.0000	0.0000		
17		0.0000	None	0.0000	0.0000	0.0000		
18		0.0000	None	0.0000	0.0000	0.0000		
ATC LOCATION : 11								
REMOVE TOOL	ADD TOOL	CALL TOOL		RETURN TOOL		RESET ATC	RETURN	

12.1.1 Tool Status Box

At the very top of the screen below the status line is a tool status box. It represents what the control thinks is the status of the tool in the spindle and ATC.

The following describes each box from left to right.

ATC Pos – This refers to the position of the ATC in relation to the spindle. The ATC location directly to the left of the spindle will be displayed in this box. As the ATC rotates, this field will update.

Loc – This box shows the ATC location from which the current tool in the spindle came from. If this box is empty it means the spindle is empty.

Tool # - This is the number of the tool that is in the spindle, as defined by your program. If no tool # has been assigned to it yet, the field will be blank. When the spindle is empty, it says NO TOOL.

Tool Diameter – This box displays the tool diameter for the tool in the spindle

Tool Description – This box displays the tool description for the tool in the spindle.

12.1.2 Tool Loading Table

ATC Loc – This box displays the ATC location the given tool is residing in.

Tool # - This displays the tool # this tool has been assigned in your program.

Diameter – This displays the diameter of your cutting tool.

Type – This displays the description of the cutting tool (ie: center drill).

Z Offset – This displays the difference in length between the cutting tool and the base tool supplied by SWI. A positive offset would mean a longer tool, and a negative offset would indicate a shorter tool.

Z Mod – This feature adjusts tool position in the Z axis. This is to aid the operator in getting the workpiece to proper dimensions or to accommodate for tool wear. This can also be used as a troubleshooting guide. The values in Z Mod should be small. If the values become large (ie: greater than .01” -.02”), this could be an indication that there is something wrong with the set-up of the tool and/or workpiece.

Dia Mod – This feature adjusts the tool diameter. In order to get proper workpiece dimensions (ie: pocket width, wall thickness etc.), adjustments can be made by putting values in this column. Also, if a part was programmed utilizing a specific diameter tool such as .5”, and the tool being used has been ground to .480” for sharpening, the operator would not have to modify the program if he inserted a value of -0.020” in this column.

Action – This column will display REMOVE or ADD as necessary when you need to remove and add tools to the ATC. The blue cursor box moves up and down this column so you can select what action you want to take place.

The data input line shows “ATC LOCATION” which displays the ATC location you are on as you move the blue cursor up and down this column.

The row in the Tool Loading table that is currently in the spindle will be highlighted in GREEN. When the spindle is empty, there is no green bar.

12.1.3 REMOVE TOOL

REMOVE TOOL is used to permanently remove a tool from the ATC. The REMOVE TOOL prompt is invoked when you press the remove tool button in the tool management screen in program setup. To remove a tool, highlight the tool you want to remove with the blue cursor box and press remove tool. A message box will appear on the screen when this button is pressed. The door must be closed to initiate all tool changes. Once the tool is placed in the spindle you can now open the door and remove the tool from the spindle by pressing the green button on the head. After this, all the tool info is removed from the ATC location, and another tool can be added in its place.

12.1.4 ADD TOOL

ADD TOOL is used to add a new tool to the ATC. The ADD TOOL prompt is invoked when you assign a new tool from your program to the ATC in tool management mode. To add a tool to the ATC, highlight the tool you want to add with the blue cursor box and press ADD TOOL. If the tool loading table shows a remove tool box for the same tool location, then you will have to remove the tool first before adding the new tool. A message box will appear on the screen when the add button is pressed. Open the door and load the tool in the spindle using the green button on the head. Once the tool is placed in the spindle you must close the door and press GO to initiate the tool change.

12.1.5 CALL TOOL

CALL TOOL is used to call a tool from the ATC to the spindle. To use CALL TOOL you need to move the blue cursor box down to ATC location that you would like to call. If you call a tool and a different tool is already in the spindle, the control will put the tool in the spindle back into the ATC before getting the new tool. Close the door and then press GO to initiate the tool change.

12.1.6 RETURN TOOL

RETURN TOOL is used to return a tool from the spindle to the ATC. To use RETURN TOOL you do not need to move the blue cursor box down to the tool that you would like to call, it will return whatever tool is in the spindle back to the ATC, no matter where you are in the tool loading table. Close the door and then press GO to initiate the tool change.

12.1.7 RESET ATC

In the event that the ATC would ever get stuck in the middle of a tool change, this feature can be used to guide you to safely recover. It will prompt you for what condition the ATC is currently in, and offer some options in order to either remove the tool that is currently in the spindle, or place it back into the carousel.

12.2 Checklist

The Checklist is used to walk the user through all 12 steps required to run a program. The bottom 7 items on the list must be done before you can run a program. The top 5 do not need to be done, but we recommend you check them prior to running. Note that the first item on the list only applies when a Master program is loaded. Otherwise it will simply say Not Applicable.

MACH S/U		MP/N 15973 Master : 15973 OP1						INCH											
MACHINE SETUP CHECKLIST																			
1.	Have you reconciled your tools in your master program?	Yellow																	
2.	Did you set your Z safety height?	Yellow																	
3.	Are all of your tool diameters entered correctly?	Green																	
4.	Have you checked your TOOL PATH?	Yellow																	
5.	Have you saved your program?	Yellow																	
6.	You must enter the ball lock location for your parts.	Red																	
7.	Are your X, Y and Z offsets set correctly for your parts?	Yellow																	
8.	If running more than 1 part per fixture, shift offsets cannot be set to all zeros.	Green																	
9.	You must assign tools to the ATC before running the program.	Red																	
10.	You must enter a tool length offset for each tool used in your program.	Green																	
11.	You must REMOVE tools from the ATC.	Green																	
12.	You must ADD tools to the ATC.	Green																	
<table border="1" style="width: 100%; border-collapse: collapse;"> <tr> <td style="width: 10%;">CHECK</td> <td style="width: 10%;">OK</td> <td style="width: 10%;"></td> <td style="width: 10%;"></td> <td style="width: 10%;"></td> <td style="width: 10%;"></td> <td style="width: 10%;"></td> <td style="width: 10%;"></td> <td style="width: 10%;"></td> <td style="width: 10%;">RETURN</td> </tr> </table>										CHECK	OK								RETURN
CHECK	OK								RETURN										

Status Lights – there are 3 different colors used to determine the status of a given step.

Green (go) – Items that have been completed or do not need any attention will be green. For the top 6 items, pressing OK turns these boxes green. The bottom 6 boxes will turn green once the activity have been completed.

Yellow (caution) – The top 6 boxes can be in a yellow state which means we recommend you check them. Pressing OK turns the box from yellow to green.

Red (stop) – The bottom 6 boxes will be red when an activity is required. Once this activity is done, the box will turn green.

CHECK – selecting this will take you to the screen where you can do the thing the item refers to. Once you finish in that screen, RETURN will take you back to the checklist.

OK – selecting this when the item is yellow will tell the ProtoTRAK PMX that you are sure about it and it will turn the item from yellow to green.

DO – when you highlight a red item, a DO softkey will appear. Press this to go to the screen where you can do the required task.

12.3 Service Codes

These are special codes that may be entered into the ProtoTRAK PMX CNC to call up routines used in installation, setting of preferences, machine checkout and service.

<p>WARNING!</p> <p>Before using service codes, be aware that some of the routines are very powerful and may change important system settings. Some of the routines cause the servos to come on and move at rapid speed.</p>
--

The Service Codes are divided into logical categories. The table below summarizes the more important ones. See the service manual for more information on using Service Codes.

Software

Code	Description	Comment
33	Software, Firmware and PLC versions	Displays current software versions and system settings.
141	Load configuration file from USB thumb drive	To load configuration files from a USB thumb drive to the PMX control.
142	Save configuration file to USB thumb drive	To save the configuration files for reloading later. When a computer replacement is necessary, saving the settings to a thumb drive for reloading them later is highly desirable.
316	Update Software	Runs the routine that copies new software from a USB thumb drive device to the ProtoTRAK system. Use this routine to install new ProtoTRAK software.
318	Activate Converter	To activate converters and other software options. See Section 3.1.6. How to Buy Software Options.

Machine Set-Up

100	Open Loop Test	Caution! Machine will move. Check for crash conditions before running. Run under the direction of service personnel.
123	Calibration Mode	Use to laser calibrate the PMX control
128	Backlash Calibration Constant	Use to load backlash compensation for each axis.
134	Friction Feed Forward Constant	Compensates for friction variance from machine to machine
135	Squareness Compensation	Used to compensate squareness errors between the X and Y axis
339	Use Z Safety Height for Z Retract	Used to run SWI test programs See note below.
400	Load foreign language MLS files	Used to download language tables that have been translated into a foreign language.

500	X, Y Ball Lock Offsets	Used to enter the offsets for ball locks A, B and C
501	Set Z Tool Change Height	Used to enter the offset for the tool changer height relative to the Z home position, and to manually move the ATC in and out.
502	Set Base Tool Height	Used to set the base tool height relative to the top of the table.
505	Over-travel Limits	Used to setup and troubleshoot software limits. Also used to get machine off a limit switch when over-traveled.
510	Spindle Setup	Used to calibrate spindle, orient the spindle in relation to the ATC, and troubleshoot any spindle encoder related issues.

Diagnostic Codes

54	Continuous Run Mode	Cycles through the program in current memory.
81	Program Panel Keyboard Test	Gives a tone feedback to a button push and highlights the button.
82	Run Panel Keyboard Test	Gives a tone feedback to a button push and highlights the button.
131	Manual DRO	Turns off servo's so you can check encoders
132	Electronic Handwheel Test	Test the EHW signals
314	Toggle Test Lights in Status Line	Used to troubleshoot control issues
319	Error Logging	Logs the machine as it runs
326	Error Message Display	Displays error messages on screen
327	Display Memory Check	Displays memory availability of various devices

Operator Defaults/Options

66	Metric Boot Up Default	To have the ProtoTRAK open up in mm measurement.
67	English Boot Up Default	To have the ProtoTRAK open up in inch measurement.
79	Turn On Beeper	Turn the beeper on when pressing keys on either of the front panels
80	Turn Off Beeper	Turns the beeper off when pressing keys
503	Set Maximum Feedrate	Sets the rapid speed for the machine. Default is 800 ipm
504	Set Part Change Position	Sets the part change position along the X axis for auxiliary function 6.
507	Reset Servo Fault	Must be run when servo amp faults
508	Toggle S Curve On/Off	Changes acceleration and deceleration of axes.
509	Select 4 th Axis Type	Must be used to select the 4 th axis design type being used for a particular machine

Service Code 339 - This service code, when set to YES, can also be used to have the head go to a different height before and after a tool change. To set the height you want, go to PART/FIX MGMT and press the Z safety button to set this value. Please be aware that the machine will still need to come down to the tool change height to change tools, so you may need to add a position move to move the X and Y axis to a safe position.

13.0 Run Mode

13.1 Run Mode Screen

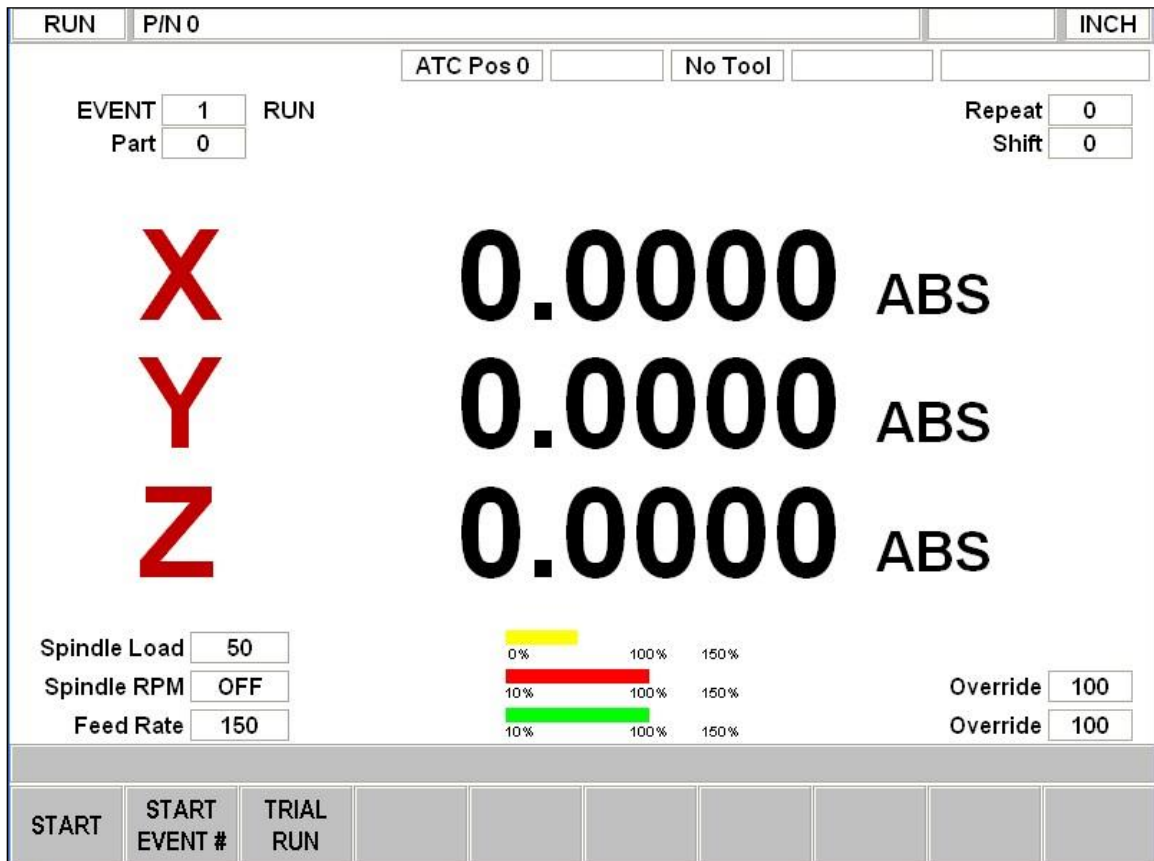

Press MODE and select the RUN soft key. Below is a description of what is displayed on the RUN screen.

There are 4 windows at the top of the screen that display the following:

RUN: displays that you are in RUN mode

P/N: displays the part number that is running

TIME: displays the total time it takes to cycle through the program.

INCH: displays whether you are in inch or mm mode.

Items in the main screen:

ATC Pos.: indicates the position of the Tool Carousel, the location that is facing the spindle

LOC: with a tool in the spindle, this window displays the carousel location that the tool belongs in.

Tool #: displays the tool number that is in the spindle.

Tool Diameter: displays the tool diameter.

Description window: displays the tool description, for example, DRILL, TAP, etc.

Event Counter: this will be the current event number and event type.

Part Counter: when running a Master Program this window displays whether you are running the 1st, 2nd, 3rd,nth part.

Repeat: if a repeat event is in the event counter, this will show which repeat number, for example, if you program a drill with 5 repeats, this will show which repeat of the event that is being machined.

Shift: when machining multiple parts using the shift in the PART/FIX MGMT screen, this will show which part is being machined.

Position: displays the absolute or incremental X, Y, Z coordinates of the machine. The display can be changed between absolute and incremental by using the ABS or INC softkeys at the bottom of the screen.

Spindle Load: displays the percent load the spindle is under when the spindle is running.

Spindle RPM: the programmed RPM as adjusted by the Spindle Override.

Feed Rate: programmed feed rate of the current move as adjusted by the Feed Override

Override: located to the right of the red bar indicates % of Spindle Override.

Override: located to the right of the green bar indicates % of Feed Override.

Yellow bar: graphical representation of Spindle Load. Displays red above 100%.

Red bar: graphical representation of Spindle Override described above.

Green bar: graphical representation of the Feed Override.

13.2 Starting To Run

13.2.1 Starting To Run - Single Program

The program may be started in the two ways identified as soft keys in the screen in Section 13.1

Pressing the START soft key begins the program at Event 1.

Pressing the START EVENT # soft key allows you to start in the middle of a program. When you press the START EVENT # soft key, the conversation line will prompt "Input Event #." Input the number of the first event you wish to run, and press SET. If the START EVENT # is a Repeat or Rotate, the conversation line will prompt "Starting Repeat Number" asking which repeat or pass you wish to start.

If multiple parts are in a fixture and the SHIFT feature is being used in the PART FIX/MGMT Screen, the conversation line will prompt "Enter the shift number". A zero shift number will machine the first part in the fixture. A shift number of 1(one) will machine the second part because it the first shift being used. Input the number of the shift and press SET. The conversation line will now prompt "Input Event #" and repeat as discussed above.

13.2.2 Starting To Run - Master Program

The program may be started in the two ways identified as soft keys in the screen in Section 13.1

Pressing the START soft key begins the program at Event 1.

Pressing the START EVENT # soft key allows you to start in the middle of a program. When you press the START EVENT # soft key, the screen will change and display the programs that make up the Master program. Use the up and down arrow keys to highlight

which program you wish to start in. Hit the SELECT soft key and the screen will change back to the RUN screen. The conversation line will prompt "Input Event #." Input the number of the first event you wish to run, and press SET. If the START EVNT # is a Repeat or Rotate, the conversation line will prompt "Starting Repeat Number" asking which repeat or pass you wish to start.

13.3 Program Run

When you have started by any of the means above, the display will show:

Part Number (P/N) being run is shown in the status line.

Event Number and type (and the repeat number, if applicable) being run is shown at the top of the screen.

Current X, Y, Z Absolute Positions are shown in the information area.

SHOW ABS: (which is automatically assumed if one of the other 3 show keys are not selected) will show the absolute X, Y, Z positions as the part is run.

SHOW INC: will show the incremental (or distance to go within the event) X, Y, Z positions as the part is run.

SHOW PATH: will show the tool path graphics as the part is run.

SHOW PROG: will show the programmed data for the event being run, and the next event as the part is run.

TRAKING: is available so the TRAKing feature can be used. Select this to control the X,Y and Z programmed motion with the Electronic Handwheel. See Section 13.4 below.

The run procedure is very simple. Follow the instructions on the conversation line and proceed by pressing the GO key.

RUN: select this softkey to start the CNC run mode.

13.4 TRAKING

TRAKING is a *special* kind of CNC run. When you press the TRAKING softkey, machine motion and tool change is controlled by turning the Electronic Handwheel. Turning the handwheel in the clockwise direction moves forward through the program; turning counterclockwise moves backward through the program. You can change the speed of movement by pressing any of the four resolution buttons to the right of the electronic handwheel. It is recommended to use one of the slower speeds when actually cutting into material.

If TRAKING is started in the middle of a program, you can only go forward in the program. After going forward in the program you can rotate the Handwheel in reverse, TRAKING can only reverse the program to the point it was turned on.

TRAKING comes in handy whenever you are a little unsure about any aspect of your program or set-up. For example, on the first run of a part - instead of pressing GO and holding your hand on the stop button, use TRAKING to bring the tool to the part while you watch the DRO. Once assured that everything is all right, press STOP and get into CNC run.

13.5 Program Run Messages

While in Run Mode, the PMX CNC will tell you in clear and concise prompts exactly what to do to run the program. These messages will appear in a green box in the middle of the screen.

Any Event Comments you entered during programming will appear on the Data Input Line (See section 7.3.2 to use Event Comments).

Once the program starts, a Run Time Clock will appear to the right of the status line at the top of the screen. This clock displays the time remaining until the end of the program or the next tool change, and will count down as the program is run. You must view your TOOL PATH in program setup for the clock to be accurate.

13.6 STOP

At any time, the program may be halted by pressing the STOP key. This freezes the program at that point. You may choose to continue running the program by pressing the CNC RUN softkey or pressing the GO key. You may also run the program by using the Electronic Handwheel by pressing the TRAKING softkey.

13.7 Feedrate and Speed Overrides

In program Run Mode, the programmed X, Y and Z axis feeds, rapid speeds and spindle speeds may be adjusted temporarily. You may override the spindle speeds or feeds with the SPINDLE OVERRIDE or FEED OVERRIDE hard keys located above and below the electronic handwheel.

Press the SPINDLE OVERRIDE key and then rotate the handwheel clockwise to increase the spindle speed, rotate counterclockwise to decrease the spindle speed. The amount of change is displayed by the Load Meters located on the bottom of the screen. Each pulse of the handwheel adjusts the spindle speed by 2%. Pressing the button a second time turns off this feature. The same can be done for Feedrate Override by pressing the button below the handwheel.

13.8 Data Errors

In order to run, a program must make sense geometrically. For example, you can't machine a .250-inch diameter circular pocket using a .500-inch end mill.

Data errors will nearly always be detected when the ProtoTRAK PMX CNC runs through a program. They may also be detected in the Set Up Mode when using the Tool Path Graphics routines. Whenever the ProtoTRAK PMX CNC detects a data error a message will appear that will tell you the error number (you may wish to record this number for troubleshooting purposes) and the event where the error was detected. This is not necessarily the event that is in error since the system often "looks ahead" to make sure there is compatibility from one event to another. In addition, an explanation is given for each data error type as well as a suggested solution. Press the RETURN soft key to go back to the Select Mode screen, correct your error, and proceed.

14.0 Program In/Out Mode

From the Select Mode screen, press the PROG IN/OUT softkey. The first screen you see will ask:

"LIST SUPPORTED PROGRAMS ONLY?"

With a highlighted YES or NO.

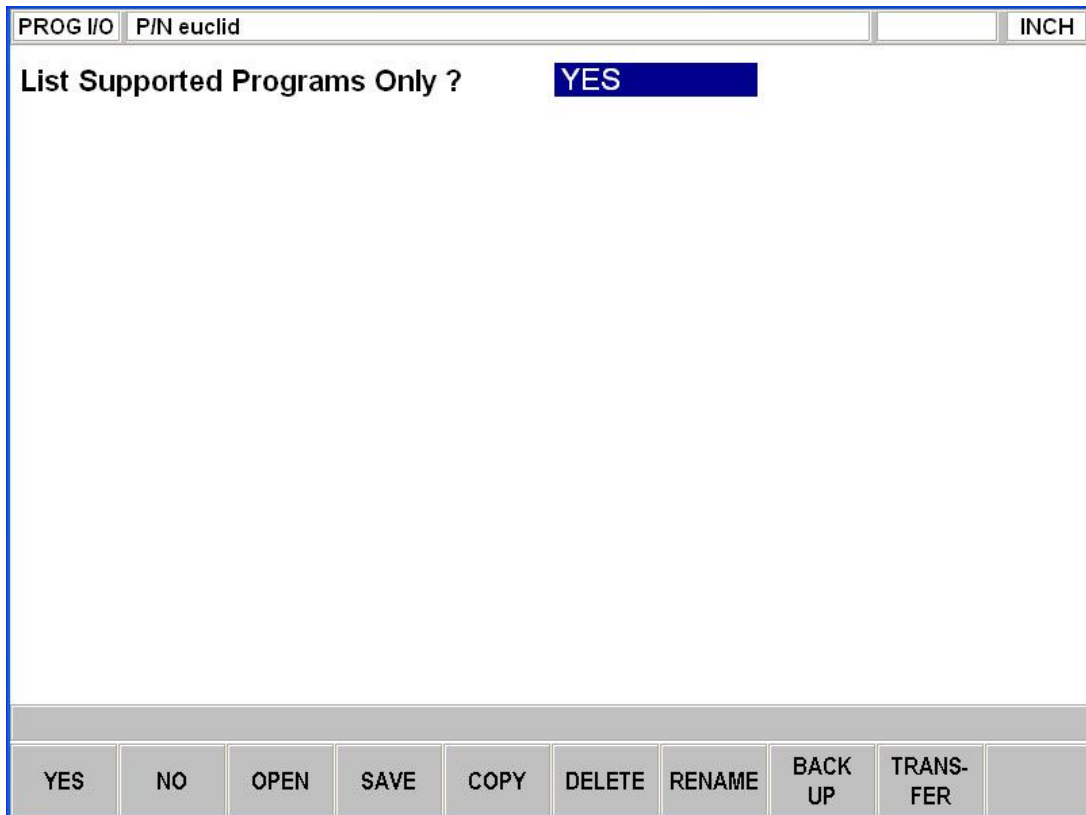

Supported programs are part programs that can run on the ProtoTRAK PMX CNC. You do not have to answer this question every time you are at this screen. Simply press the softkey for the operation you want.

Select YES to only display the file extensions that the ProtoTRAK supports, such as PT4, PT7, CAM, etc. Otherwise, select NO to view all the files that are in the specified path.

14.0.1 Filenames and File Extensions

Most places in the ProtoTRAK PMX CNC, we refer to the program or part. In Program In/Out Mode, this program or part is called a file. Filenames are program names or part names. They are the name you give to the programs you write on the ProtoTRAK PMX CNC, plus a file extension. Although the ProtoTRAK PMX CNC can have program names up to 20 characters that use letters and special symbols, most other CNC's must have file names that are eight or fewer characters using numbers only.

File extensions are part of filenames that help describe the file. They appear after the filename and are composed of three letters following a period. For example, .doc is the extension that appears after a file name for a file stored using Microsoft Word™.

Usually, but not always, the file name indicates what program was used to create the file. Sometimes this is not the case. Some programs, like those found in early models of CNC, do not attach a file extension to a file name at all. Also, a user may attach his own extension to a file name for his own purposes. Here are the file types that are supported on the ProtoTRAK PMX:

MX3 – From legacy 2½ axis ProtoTRAK products, such as the ProtoTRAK MX3, M3, AGE3, and QMV.

PT4 – From previous models of our ProtoTRAK controls, the SM, VM, and SMX.

PT7 – New to the ProtoTRAK PMX control. This is similar to the PT4 structure, but also adds to it notes, pictures, and new event types specific to the PMX control.

PTM – Also new to the ProtoTRAK PMX, this file type represents a Master program, which can be up to 4 programs combined to run in sequence. See section 14.3.1 on how to create a Master program.

CAM - Open a g-code file as a CAM file in order to convert the program into our event structure. From there you gain the advantage of being able to quickly edit the program using our user interface. This is ideal for smaller g-code files that are running 2½ axis work. Any g-code type that is not recognized will be ignored. See section 14.13 for more on CAM files.

GCD – Opening a g-code file as a GCD file will skip the conversion process, and run the g-code as is. This saves system resources and allows you to run larger g-code files, as well as running full 3 axis work. The program can be edited in our G-Code Edit page. For more on GCD file types, see section 14.11.

PTG – Another new file type to the ProtoTRAK PMX, this represents a GCD program that also has notes, pictures, and fixture offsets saved along with it for future use.

DXF and DWG – These file types represent graphic drawings made from CAD software. Although they may look like the part you wish to cut and have accurate dimensions, they still lack toolpath information (such as spindle speed, feedrate, tool info, direction of cut, etc). Consult your DXF manual for more on how to use the DXF converter.

14.1 Softkey Selections in the Program In/Out Mode

YES: to display only supported programs.

NO: to display all files.

OPEN: to bring a program from storage into the current memory.

SAVE: to save the program that is in current memory to storage.

COPY: to select and make a copy of a file in storage for pasting in another storage location.

DELETE: to remove a file from a storage location without altering the current memory.

RENAME: to rename a file or folder.

BACK UP: to perform a convenient back up of program files to another storage location.

TRANSFER: to transfer a program from the Staged mode to the Current mode, including notes and pictures. This will also update the Tool Management with any changes made from Staged mode.

14.2 Basic Navigation of Program In/Out Mode Screens

The screens in the Program In/Out Mode do not have the normal ProtoTRAK look and feel because they are derived from the Windows operating system. Most functions may be performed using a mouse or keyboard. Softkeys are provided to operate the system through the control's keys.

14.2.1 Basic Parts of the Program In/Out Mode Screens

The status line at the top of the screen will display:

- The Mode
- The program name for the program in current memory (if any)
- Whether the ProtoTRAK is in INCH or MM mode

The Look In area shows the storage areas (or drives) and directories that are being displayed below in the listing area.

In the listing area (the biggest part of the screen) appears all the files and folders for the location shown in the Look In box.

The File Name box shows the program file on which the operation will be performed.

Parts of the screen unique to specific operations will be discussed below.

14.2.2 Softkeys in the Program In/Out Mode Screens

Use the following keys to move around any of the screens in the Program In/Out Mode:

Arrow Buttons: Use the arrow buttons on the front panel of your ProtoTRAK PMX to move the highlighted cursor up, down, left, or right.

TAB: Use this softkey to move the highlight between the parts of the screen. Where applicable, tabbing to an area will cause a drop-down box to appear, showing all the selections possible.

OPEN FOLDER: Use this softkey to open a highlighted folder that contains program files. When the highlight is on the root directory, this will collapse the list displayed and show the next level up. The root directory is represented by a folder with an up arrow followed by two periods. The root directory will disappear when the most basic organization for the drive in the Look In box is reached.

14.3 Opening a File

To open a program file from a storage location, press the OPEN softkey from the Program In/Out Mode screen. The ProtoTRAK PMX CNC will always default to the last folder you had open.

Find the file using the softkeys as described above in the section on basic navigation.

When a program file name is highlighted, press the LOOK hard key to see a graphical representation of the part program. The graphics are not a precise representation of the tool path, but should be very handy in helping to identify a file before opening.

In addition to the basic parts of the screen described above, two additional parts of the screen appear in the open operation:

File Name: - Displays the name of the file that is highlighted from the list.

Open As: - lists the formats for which the file may be opened. The default is .PT7.

Three additional softkeys appear:

CREATE MASTER: Press this button to combine up to 4 programs to run as one operation. See section 14.3.1 for more on this.

OPEN FILE: Opens the highlighted program file and puts it in current memory. Only one file may be in current memory at a time, if one is there already, a warning message will appear before that file is overwritten.

RETURN: Returns to the Program In/Out Mode screen.

When the open operation is finished, the system will return to the Select Mode screen.

14.3.1 Creating a Master Program

Creating a Master Program is a new feature introduced in the ProtoTRAK PMX CNC. It allows the user to select up to 4 already existing programs and combine them to run sequentially. Say for example, you have multiple programs written already to cut on 4 different sides of the same part, now you can combine those programs and have the ability to make the tool path more efficient by choosing a run strategy (see Section 11.4 for more on Run Strategy).

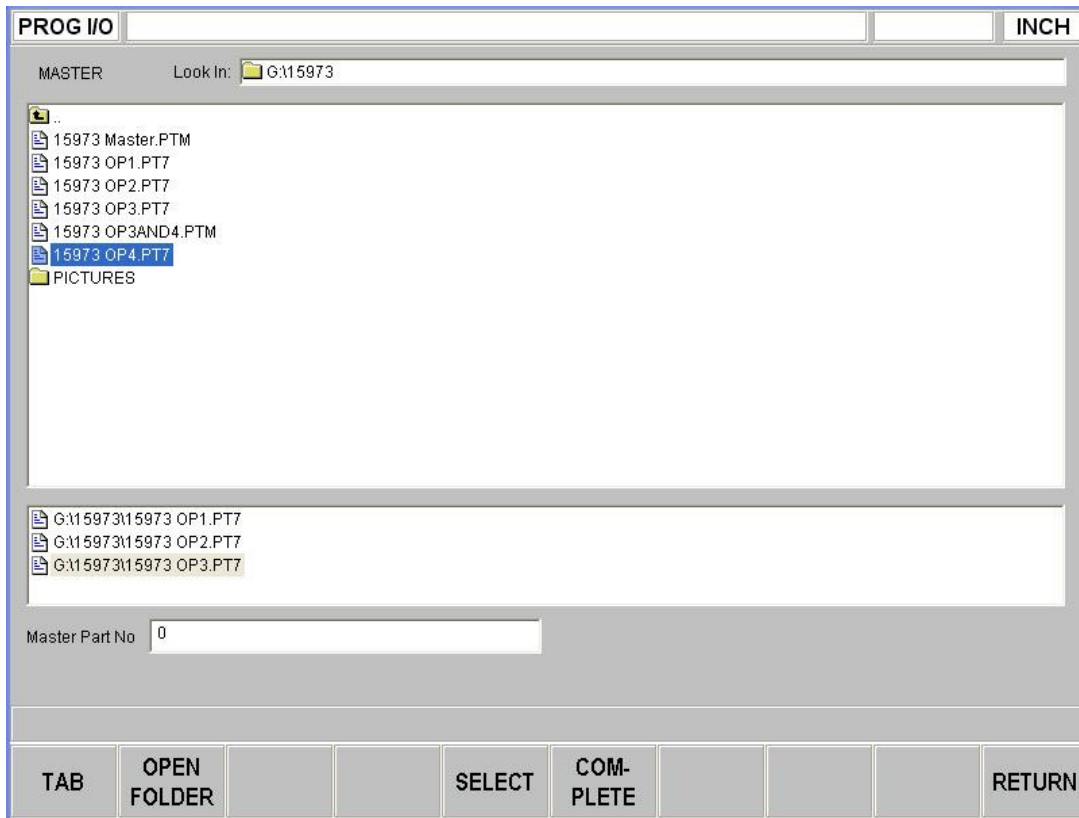

Creating a Master Program

After pressing the CREATE MASTER softkey, you will be prompted to select up to 4 files that you wish to work with. Use the arrow keys to move the highlight around, and then press the SELECT button to add the file. In the lower display window, you will see the list of files that are to be combined, as shown above. Once you have selected all the files you wish to work with, press the COMPLETE softkey, and you will automatically be taken to the Tool Recon page. See Section 11.5 for more on Tool Recon.

When it is time to save your Master program, remember to save it as a PTM file.

14.3.2 Preview Graphics

As an aid to finding the file you want to open, the ProtoTRAK PMX allows you to look at the part graphics before opening. Simply select the file and press the LOOK hardkey. The screen will show the part graphics. Press LOOK again or RETURN to revert back to the Program In/Out screen.

The graphics displayed in this process are not exact, but are a handy representation of the program.

Note: DXF, GCD, and PTG files may not be previewed with the LOOK feature.

When previewing a Master program, you will see a NEXT button so that you may cycle through part graphics of each program saved within the master.

14.4 Saving Programs

To save a program file to a storage location, press the SAVE softkey from the Program In/Out Mode screen.

Find the drive and folder you want to save the program file in using the softkeys as described above in the section on basic navigation.

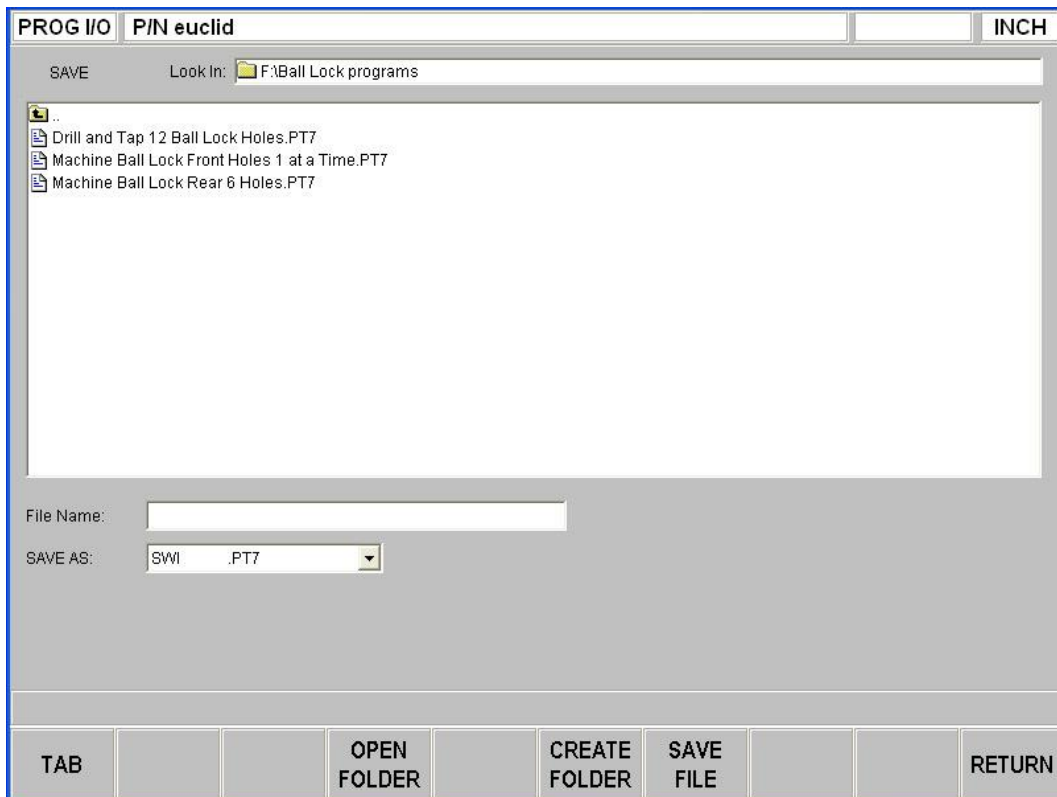

The Save Screen

Two additional parts of the screen appear once the SAVE softkey is pressed:

File Name: displays the name of the file that is in current memory.

SAVE AS: lists the formats for which the file may be saved. The default is .PT7.

Three additional softkeys appear:

CREATE FOLDER: Use this to create a new folder for the program file. This new folder will be added to the list shown in the listing area, at the same level of organization as the files and folders shown. Once the CREATE FOLDER softkey is pressed, a Data Input Line will appear for entering the name of the folder. The name "Folder1" will be written in the box. To accept this name, press SET. You may input a name you select by writing over this name. Use the same procedure for naming a program (see Section 7.3.1).

SAVE FILE: Saves the program file to the location shown in the Look In area.

RETURN: Returns to the Program In/Out Mode screen.

Once the save operation is finished, you will see the file name added to the files in the listing area.

Note – the ProtoTRAK PMX will not allow you to save to the C drive since it is reserved for the XP operating system and ProtoTRAK software. The LPM does come with a USB storage device that is found on the computer module in the electrical cabinet. It will be called drive D. You can also add additional USB storage devices to the USB ports found on the right side of the control pendant. It is good practice to save all your programs within folders because this will allow you to easily backup all of your programs when using our BACKUP feature found in section 14.8.

14.5 Copying Programs

To copy a program file from one storage location to another, press the COPY softkey from the Program In/Out Mode screen. Only one file may be copied at a time using this operation. To copy multiple files or folders, see Section 14.8.

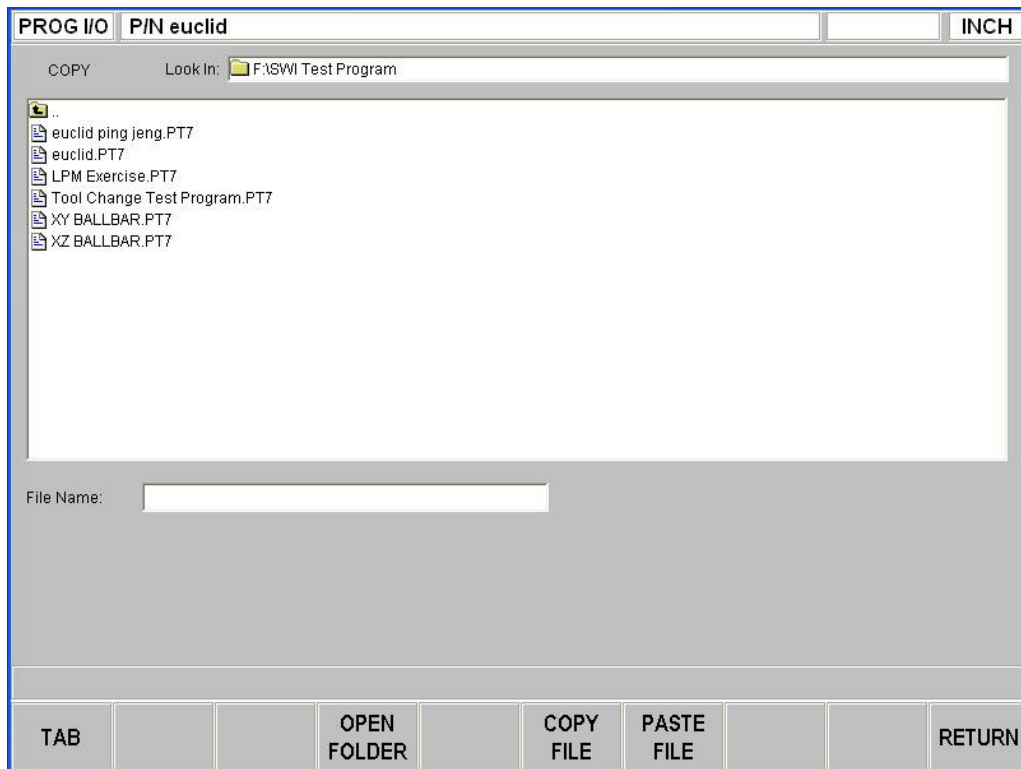

The Copy Screen

The copy operation is in two parts. First, use the navigation procedure described in Section 14.2 above and highlight the program you wish to copy. Press the COPY FILE softkey to copy the file. Then go to the new file or drive, open it using the OPEN FOLDER softkey and press PASTE FILE. Once the file has been copied, it can be pasted to as many other locations as you want.

Additional softkeys in COPY:

COPY FILE: Makes a copy of the highlighted file.

PASTE FILE: Writes a copy of the file to the location shown in the Look In box.
RETURN: Returns to the Program In/Out Mode screen.

When the pasting operation is finished, you will see the file name added to the listing area.

14.6 Deleting Programs

Programs in current memory are removed from current memory in Edit Mode. See Section 10.3

To remove a program file from a storage location, press the DELETE softkey from the Program In/Out Mode screen.

Use the navigation procedure described in Section 14.2 above and highlight the program file or folder you wish to delete. Press the DELETE FILE or DELETE FOLDER softkey. A warning message will appear for confirmation.

Additional Softkeys in DELETE:

DELETE FILE: Press this to delete a file.

DELETE FOLDER: Press this to delete a folder.

Softkeys that appear with the confirmation message:

YES: Press this if you want to delete.

NO: Press this if you do not want to delete. The delete operation will be aborted and the previous softkey selections will return.

When the delete operation is finished, the file or folder name will disappear from the listing area.

14.7 Renaming

To rename either a file or a folder, press the RENAME softkey from the Program In/Out Mode screen.

To rename a file or folder:

1. Use the navigation procedure described in Section 14.2 above and highlight the program file or folder you wish to rename.
2. TAB to the New Name area and enter a new name. Use the same procedure as for naming a program (see Section 7.3.1).
3. TAB to the New Extension and enter a new extension.
4. Press either RENAME FILE or RENAME FOLDER.

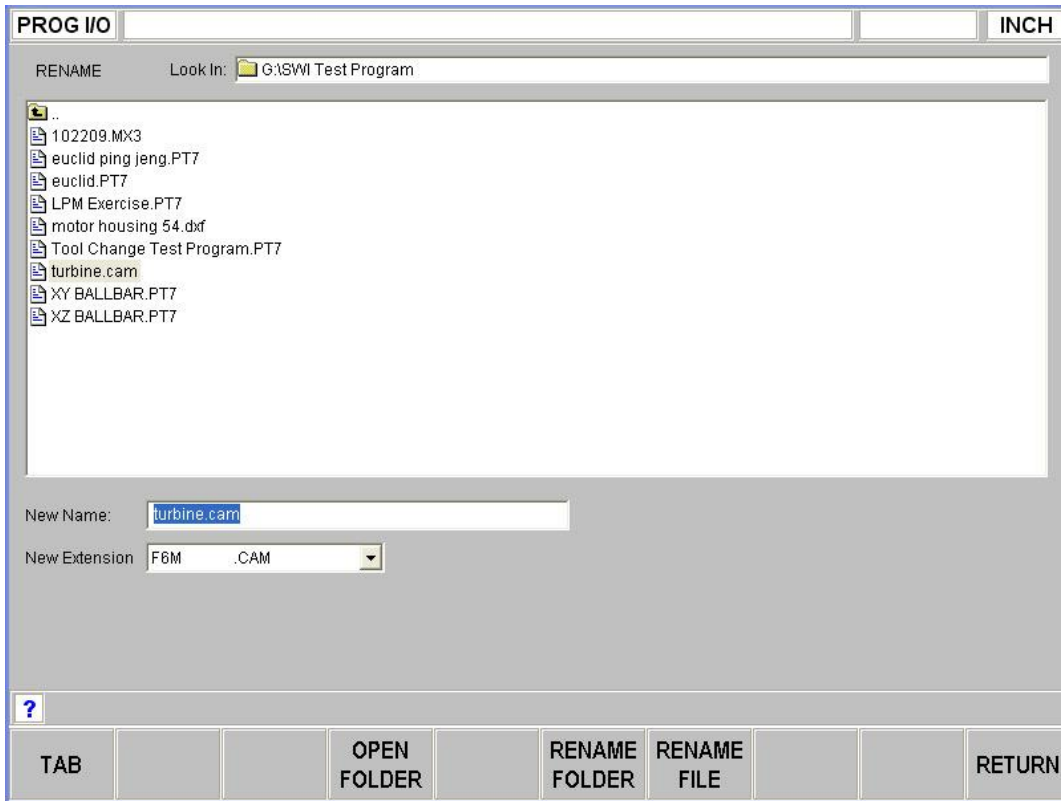

Renaming a file. Press the HELP hard key to call up the alpha keys

Additional parts of the screen appear once the RENAME softkey is pressed:

New Name: When a file or folder is highlighted, the name will appear here. When the TAB, the RENAME FILE or RENAME FOLDER softkey is pressed, the highlight will move here and you will then be able to write in a new name.

New Extension: A new extension can be given to the file picking from the ones available. If the file name already contains an extension, you will have to erase the old one before giving it a new one.

Additional softkeys:

RENAME FOLDER - Press once a new name has been entered into the New Name and New Extension areas to change the name of the folder.

RENAME FILE- Press once a new name has been entered into the New Name and New Extension areas to change the name of the file.

RETURN - Returns to the Program In/Out Mode screen.

14.8 Backing Up

In order to protect your important programs, it is a good idea to back them up regularly. That way, if your media device ever becomes unusable, you will not have to re-write the program.

To back up your files, press the BACK UP softkey from the Program In/Out Mode screen.

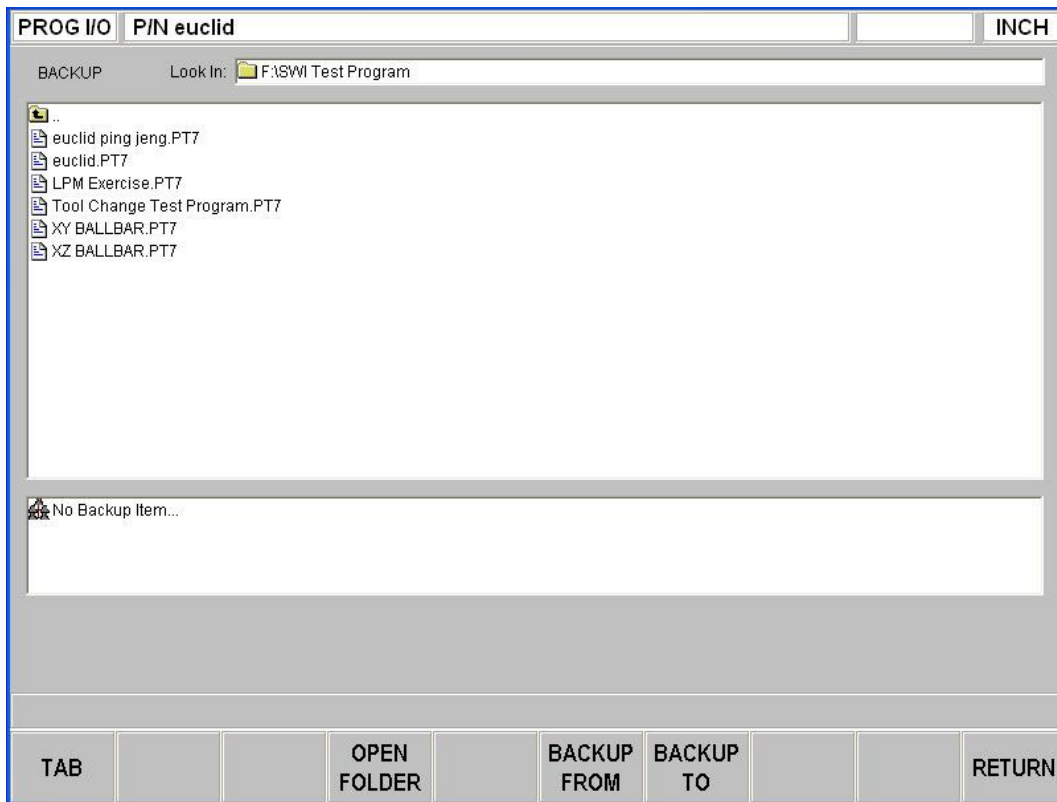

Backing up. The top part of the screen shows all the items in Drive F. The bottom part shows the items that have been picked for backing up

The basic procedure for backing up is:

1. Use the navigation procedure described in Section 14.2 above and highlight the program file or folder you wish to back up.
2. Press the BACKUP FROM softkey. You will see the item appear, along with its directory path, in the new listing area under the main listing area.
3. Repeat the above for as many items as you wish.
4. Use the navigation procedure to select a different drive or a different folder.
5. Open the drive or folder using the Open folder key.
6. Press BACKUP TO.

When the back up operation is completed, you will see the items and their directories in the new location.

Note: It is good practice to back up files to a different drive, rather than to a different folder on the same drive. For example, if you keep your programs on the USB flash drive, it is a good idea to back them up to another computer. That way, if the USB flash drive becomes unusable, you will have the part programs somewhere else so that you can reload them when the problem with the flash drive is resolved.

14.9 Converters™

Converters are programs within the ProtoTRAK PMX CNC that translate CNC program files of another format into a ProtoTRAK PMX CNC file, or a ProtoTRAK PMX CNC file into a different format. With converters, you can run programs written on the ProtoTRAK PMX CNC on a machine that does not have a ProtoTRAK PMX CNC and vice versa.

Each ProtoTRAK PMX CNC comes with converters for other ProtoTRAK and TRAK CNC's.

Program conversions take place by first translating the file into a neutral run engine, then from neutral to the desired file format. For this reason, you should think of conversions as being only one way. The conversion process changes the file in ways that are harmless and so the results are correct. However, when converted back, it will not be the same as it was originally written; it will create the same part, but some of the lines of code will be different.

14.9.1 Activating Converters

Converters must be activated before you can use them. Standard converters include those that handle the translation between the ProtoTRAK PMX CNC and other TRAK CNC's. Optional converters are purchased separately. Standard converters and optional converters that are ordered and shipped with the machine are activated at the factory.

You can tell which converters are activated by looking in the Open As or Save As windows, shown below.

If you purchase a converter after you have installed your machine, you must activate it yourself using the procedure described in Section 3.1.6.

14.9.2 Converting From a Different Format into a ProtoTRAK PMX CNC

Conversions from a different format into a ProtoTRAK PMX CNC occur when the file is opened.

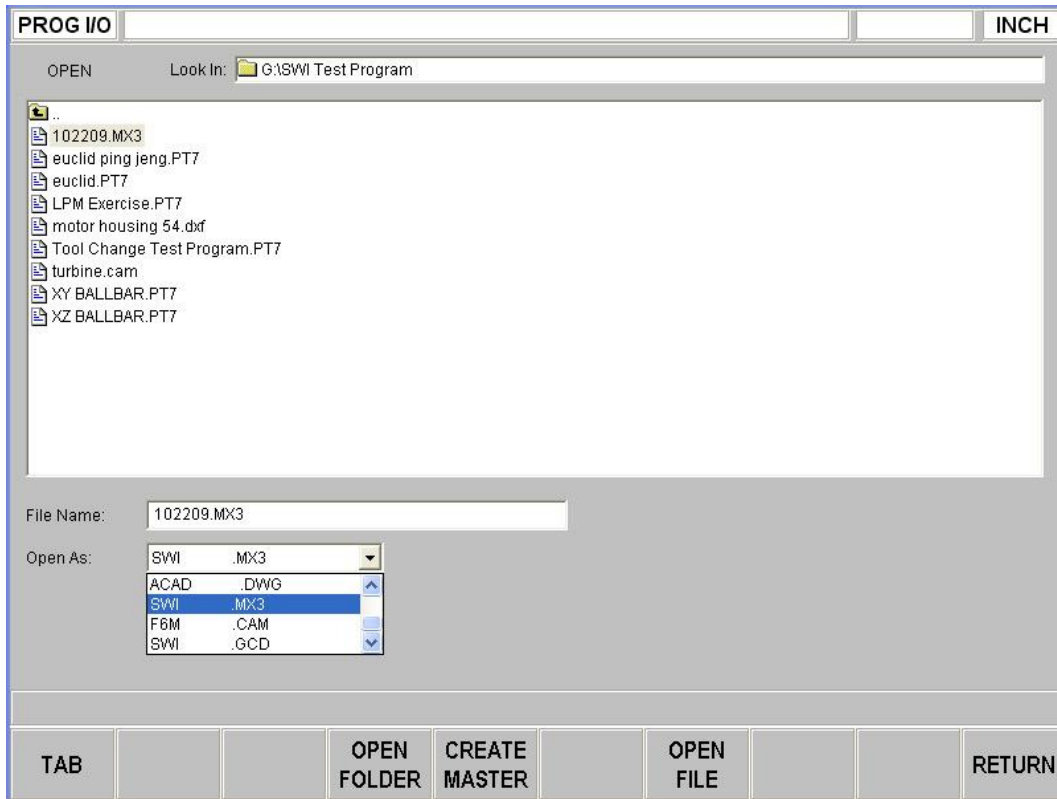

Use the Open As box to tell the ProtoTRAK PMX CNC what kind of file it is

Use the Open As box to tell the ProtoTRAK PMX CNC what format the file is in so that it knows how to convert it to the ProtoTRAK PMX CNC format. In the image above, the ProtoTRAK PMX CNC could guess that the file to be converted was from a previous version of ProtoTRAK because of its file extension (.mx3). But since file extensions may be missing or may not really describe the file format correctly, you can use the Open As box to declare the file type.

The drop-down menu in the Open As box shows which converters are available. If a converter is not listed, you can check to see if it is activated (see section 3.1.6).

14.9.3 Converting From the ProtoTRAK PMX CNC to a Different Format

Files, or programs, are converted from the ProtoTRAK PMX CNC to a different format using the Save function of Program In/Out Mode.

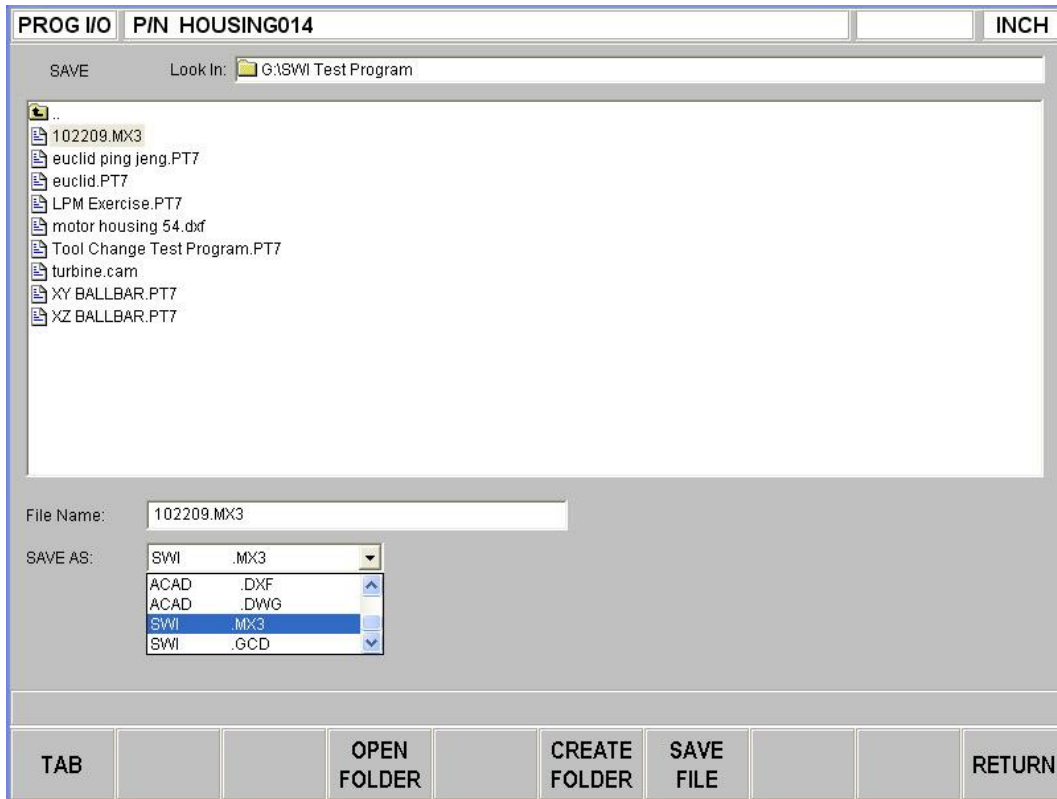

Use the Save As box to tell the ProtoTRAK PMX CNC what kind of file you want the current program (in the .PT4 format) to be converted into.

In the image above the file name 102209 is being saved on drive G as a .mx3 file. Note that although the program or part name as shown in the status line is HOUSING014, the file name given for converting the file conforms to the .mx3 format – fewer than eight characters long and consisting of numbers.

14.10 ProtoTRAK and TRAK CNC Compatibility

File exchange between the ProtoTRAK PMX CNC and other ProtoTRAK and TRAK CNC's is possible because the ProtoTRAK PMX CNC is backward compatible. In other words, the ProtoTRAK PMX CNC can store and retrieve other ProtoTRAK and TRAK CNC files. The actual transfer of the files can be accomplished by using a USB flash drive and/or Ethernet cable. In order to transfer files between the ProtoTRAK PMX CNC and previous generations of ProtoTRAK and TRAK CNC, you must have the .MX3 converter activated. See Section 14.9 above.

Note: Previous ProtoTRAK and TRAK CNC's allow numeric filenames of eight (8) characters or less, while the ProtoTRAK PMX CNC allow alphanumeric filenames (letters and numbers) of up to twenty five (25) characters. Be sure to use only numeric filenames when storing a file on a ProtoTRAK PMX CNC that will be retrieved by previous ProtoTRAK and TRAK CNC's. Before conversion, you can easily rename the file in the ProtoTRAK PMX CNC current memory.

14.10.1 File Formats

The ProtoTRAK PMX CNC can store and retrieve the following ProtoTRAK and TRAK CNC file formats.

Previous ProtoTRAK and TRAK CNC file formats:

ProtoTRAK M3 .mx3
ProtoTRAK MX3 .mx3
ProtoTRAK MX3E .mx3
TRAK AGE3 .mx3
TRAK QMV .mx3

ProtoTRAK SM .pt4
ProtoTRAK VM .pt4
ProtoTRAK SMX .pt4

14.10.2 Opening .MX3 and .PT4 files on a ProtoTRAK PMX CNC

Programs written on previous generation ProtoTRAK and TRAK CNC's may be opened and run on the ProtoTRAK PMX CNC. The ProtoTRAK PMX CNC will automatically convert the file (.MX3 or .PT4) to a .PT7 file. The original file will remain on the storage device unchanged and the converted file will be in current memory. You will have to save the converted file using the procedure in Section 14.4 above in order to place into storage.

Note that older-generation ProtoTRAK and TRAK CNCs had a 3 and 4-sided pocket canned cycle. This event type will be recognized and run by the PMX CNC, but converted into an Irregular Profile event.

14.10.3 Running ProtoTRAK PMX Files on ProtoTRAK and TRAK CNC Controls

In order to have a program written on a ProtoTRAK PMX run on a previous version of ProtoTRAK or TRAK CNC, you will need to save the program as either a .MX3 or .PT4 file (depending on the control or program you want to run).

Since there are some feature differences between the CNC's the process will generally yield a useable .mx3 or .pt4 program but with the following exceptions:

Event or feature	Comment	Result
Hidden Areas in Irregular Pocket	The ProtoTRAK or TRAK CNC does not recognize Hidden Areas in Irregular Pockets.	The Irregular Pocket will be converted to an Irregular Pocket; however, the ProtoTRAK or TRAK CNC will display an error message that there are Hidden Areas in the Irregular Pocket. We recommend that you separate the Irregular Pocket into two or more Irregular Pockets using the ProtoTRAK PMX before conversion.
Tap Events	This routine does not exist in all models of the ProtoTRAK or TRAK CNC.	The routine will be ignored in the converted program. We recommend that you reprogram the Tap Events into Drill or Position events before conversion.
Copy Repeat Subroutines with %Feed	The %Feed or %RPM function does not exist in all models of	The %Feed or %RPM information will be removed from the Copy Repeat Subroutines. The programmed

or %RPM	the ProtoTRAK or TRAK CNC	feed rates will be run. We recommend that you inspect the feed rates before running the program on the ProtoTRAK or TRAK CNC when the %s are other than 100%.
Tool Path Programming	Only Part Geometry programming is supported on the ProtoTRAK or TRAK CNC.	You can only transfer Part Geometry programs to the ProtoTRAK or TRAK CNC.
Zig-Zag Entry Mode Ramps	This routine does not exist in the ProtoTRAK or TRAK CNC.	The routine will be converted to a Plunge routine. We recommend that you check your Z feedrate to make sure it will be correct for a plunge.
Event Comments	Event comments are not supported on the ProtoTRAK or TRAK CNC.	Event comments will be ignored.
Thread Mill	This routine does not exist in the ProtoTRAK or TRAK CNC.	Thread Mill events will be ignored. We recommend that you replace these events with the Helix Events and Mill Events to ramp in and ramp out of the helix.
Tool Table Info	The part programs for ProtoTRAK or TRAK CNC do not contain tool table information. This information is kept separately.	Tool table information will have to be set in the ProtoTRAK or TRAK CNC as usual.
Irregular Profile	The ProtoTRAK or TRAK CNC does not contain an Irregular Profile Event.	The Irregular Profile Event will be converted to Mill and Arc Events and the programming of the finish cut and steps will be lost. We recommend that after conversion, you add repeat events for the steps and finish cut, using the technique of overstating the size of the cutter you will use to cut the profile.
Face Mill	This event type does not exist on older ProtoTRAK controls.	The Face Mill event will be ignored. We recommend you replace with a rectangular or irregular pocket.

14.11 Running G Code Files (GCD)

The ProtoTRAK PMX allows you to run G Code files directly without having them converted to the ProtoTRAK PMX programming format. You may want to do this if you have a very large CAM file made up of small XYZ position moves, or if there is complex surface contouring. In these cases, the ProtoTRAK PMX can handle the files more efficiently by running the G Code directly. While running the G Code file directly does not give you the benefit of the easy programming format of the ProtoTRAK PMX, you are not likely to be able to use this benefit with a very large or complex file anyway.

To run the G Code file directly, open the file using OPEN AS: .GCD. The entire program will be brought into current memory. You will be able to view the tool path when you run the program in the Run Mode, but you will not be able to edit the program or view it in the Program Mode. In order to edit the program, use the G-Code Editor in the Edit Mode (Section 10.5).

14.11.1 G Codes Recognized by the ProtoTRAK PMX GCD Converter

G Code	Description	Sample Code	Notes
G00	Position at maximum feedrate	G00 X0.0 Y0.0 Z0.0	

G01	Linear Interpolation	G01 X0.0 Y0.0 Z-1. F15.	F = Feedrate in Inches per minute
G02	Circular Interpolation (Clockwise)	G02 X1. Y2. I0. J2. (see note below)	I, J, and K define the X,Y, and Z center points respectively. Values are incremental from the starting point of the arc.
G03	Circular Interpolation (Counter-clockwise)	G03 X2. Z0. I2. K0. (see note below)	
G04	Dwell	G04 P1000	P specifies # of milliseconds. P1000 = 1 second
G06	Helix (Clockwise)	G06 X0. Y0. Z0. I1. J0. K0. D2.0	D defines the # of revolutions.
G07	Helix (Counter-clockwise)	G07 X0. Y0. Z0. I1. J0. K0. D2.0	
G17	Select XY Plane	G17	G17 - G19 only apply to G2 and G3.
G18	Select XZ Plane	G18	
G19	Select YZ Plane	G19	
G20	Input in Inch	G20	Default
G21	Input in Metric	G21	
G40	Cutter compensation cancel	G40	
G41	Cutter compensation left	G41	
G42	Cutter compensation right	G42	
G54	Select Work Coordinate #1	G54	Offsets for these are defined through our control conversationally.
G55	Select Work Coordinate #2	G55	
G56	Select Work Coordinate #3	G56	
G57	Select Work Coordinate #4	G57	
G58	Select Work Coordinate #5	G58	
G59	Select Work Coordinate #6	G59	
G61	Exact Stop mode	G61	
G64	Continuous Cut mode	G64	
G80	Canned cycle cancel	G80	
G81	Drilling cycle, spot boring	G81 X0. Y0. Z-1. R.1 F15.	Z = final depth, R = rapid position
G82	Drilling cycle, counter boring	G82 X0. Y0. Z-1. R.1 P500 F15.	P = dwell time in milliseconds
G83	Peck drilling cycle	G83 X0. Y0. Z-1. Q.125 R.1 F15. Or G83 X0. Y0. Z-1. I.1 J.125 K.1 R.1 F15.	Q = depth of peck I, J, and K values are all incremental. I = depth of first cut J = amount per peck K = min depth cut
G84	Tapping cycle	S300. G84 X0. Y0. Z-2. R.1 B0. Q.05	S = RPM B = Begin depth Q = Pitch Feedrate is calculated by S x Q

G85	Boring cycle	G85 X0. Y0. Z-1 R.1 F15.	
G86	Boring canned cycle with retract	G86 X0. Y0. Z-2. R.1 B35. Q.020 P300 F15.	B = Angle of boring head. Q = Retract distance, away from B.
G89	Boring cycle, dwell at bottom	G89 X0. Y0. Z-1 R.1 P800 F15.	P = dwell time in milliseconds
G90	Absolute Mode	G90	Default
G91	Incremental Mode	G91	
G98	Use previous Z position as Rapid plane	G98	Default
G99	Use R value as Rapid plane.	G99	
G110	Select Work Coordinate #7	G110	
G111	Select Work Coordinate #8	G111	
G112	Select Work Coordinate #9	G112	
G113	Select Work Coordinate #10	G113	
G114	Select Work Coordinate #11	G114	
G115	Select Work Coordinate #12	G115	

14.11.2 M Codes Supported by the ProtoTRAK PMX CNC

M00 program stop (press go to proceed)
M02 end of program (no rewind)
M03 spindle on CW or FWD
M04 spindle on CCW or REV
M05 spindle stop
M06 tool change
M07 air blast ON
M08 flood coolant ON
M09 coolant OFF
M10 4th axis Auto clamp ON (default)
M11 4th axis Auto clamp OFF
M21 Indexer – pulse ON
M22 rapid to part change position
M30 end program (rewind stop)
M38 air blast OFF

All other M codes will be ignored.

Notes:

1. Place M Codes on same line as movement G Code.
2. One M Code per block.
3. All values are in Absolute, except for I, J, and K values for arcs.
4. The AUX button is used to turn coolant on and off based on the spindle being on and off. When the spindle is on, the coolant is on.

14.11.3 Valid Characters for Word/Address Sequences

G	Prepare to execute a G COMMAND	ParseGcode
M	Prepare to execute a M COMMAND	ParseMcode
N	Introduces a block number	ParseEventNum
T	Specifies the tool number to use	ParseToolNum
F	Specifies a feedrate	ParseFcode
S	Specifies a spindle rpm	ParseScode
D	Specifies the diameter for the current tool	ParseDval
E	Optional parameter	ParseEval
X	Specifies the X dimension	ParseXval
Y	Specifies the Y dimension	ParseYval
Z	Specifies the Z dimension	ParseZval
I	Specifies the incremental X dimension	ParseIval
J	Specifies the incremental Y dimension	ParseJval
K	Specifies the incremental Z dimension	ParseKval
L	An Optional Parameter	ParseLval
P	An Optional Parameter	ParsePval
(Introduces a comment	ParseComment

G-Code and Post Processors.

In order to run a G code program, the program must be posted through a post-processor that makes some adjustments to the output of the G code so that it is understood by the ProtoTRAK. The ProtoTRAK uses a post-processor that is very similar to the Fanuc 6M, but there are differences. You need to make sure you use a post designed for our control. A generic post will most likely not work.

If you are not familiar with writing a post-processor, we recommend that you contact your CAD/CAM supplier. We will be happy to work with them to get you the post-processor you need.

Writing a Post Processor

The following are modifications to a Fanuc 6 post-processor that are necessary for writing the ProtoTRAK post-processor.

Beginning file format: The ProtoTRAK has no special requirements, it does not need any special characters.

End of file format: the ProtoTRAK requires the % to show the end of the file. Characters after the % will be ignored.

Beginning of an operation: the ProtoTRAK requires that the tool number, feedrate and tool comp appear before, or on the same line, as a move command. The absolute zero of the ProtoTRAK is set in a different mode and does not need to be set at the beginning of each operation. The feedrate is modal, once it is set, it remains the same until changed.

Coordinates: may be formatted in inch or metric. The addresses used for specifying coordinates are X, Y, Z, I, J, K. The valid ranges are:

- Inch: min -999.9999 to max +999.9999

- Mm: min -9999.99 to max +9999.999

Integer values MUST be followed by decimal. Ok to truncate 02.0000 into 2.0

Linear moves: G01 are formatted the same as rapid moves.

Arcs: Arc centers are specified by the address I, J and K for the X, Y and Z axes. The number following the I, J and K are incrementally referenced from the starting point of the arc. Radius values are not allowed.

Tool Numbers and Tool Changes: the format of the tool number is from T1 to T99. The M06 command initiates a tool change.

Feed rates: the ProtoTRAK is programmed in inches (or mm) per minute using the 'F' address.

Spindle speed: S1000 means 1000 RPM

Turning the Spindle on: the spindle is turned on with M03 or M04 command.

Notes

1. Tool offsets, diameters, modifiers, home positions and work offsets are defined on the ProtoTRAK control and are ignored through G code.
2. G2 and G3 are not used for helix. See G06 and G07.
3. You must specify an I, J and K for all arcs, even if you are doing an XY plane arc where the Z axis is not moving. In this case the K value must be defined. It will be modal from there on.
4. For lead in moves where you are using G41 or G42, G41 and G42 need to be placed before the Z axis moves down to position so the tool is compensated along X and/or Y correctly before performing a lead in move.

14.12 Networking

The subject of networking is extensive. This portion of the manual will give you basic instructions for setting up a simple peer-to-peer network and some system information useful to network administrators.

A network is simply two or more computers connected (usually by a cable) so they may share information. Networks within a single building are called LANs for Local Area Network.

The benefit of networking is that you can move information easily between computers. This ease of use enables some handy functionality, for example:

1. An effective file Back-up routine. File back-ups are essential if you want to retain programs for future use. Any hard drive or floppy drive could fail. Having program files backed up to a different location saves you from rewriting the programs from scratch if a failure occurs.
2. An easy way to import CAD/CAM or DXF files from other computers.

3. An effective revision control. Having a single shared folder on the network enables you to have a single location with all the latest versions of the programs.

Of course, the above functions are possible without a network by shuttling floppy disks around. The reason to have a network is that it saves time. Once it is set up, you can do repetitive functions without much work. For example, if a particular job requires you to run a CAM file that you don't have on the ProtoTRAK already, going to the pre-arranged networked location using the Program In/Out of the PMX gets you going right away. Without networking, someone has to make you a disk with the file on it. Another example is program file back-ups. With networking, you can back-up with a simple routine in the Program In/Out Mode. Without networking, you must have a good system for managing floppy disks, including labeling, storage and retrieving program files. You are more likely to do regular back ups if the process is easier.

Networking can be tricky. If you do not have experience setting up a network, be warned. Computer companies haven't done for networks what we have done for CNCs. Getting everything to work properly can require hours of troubleshooting, even for experts. There are instructions below to guide you through the most basic case of establishing a peer-to-peer network. Beyond that, you should consult a qualified Network Administrator.

Virus Protection:

As a device, ProtoTRAK CNCs are not generally susceptible to viral infections. The part "programs" they run are non-executable text files. You can further assure protection by avoiding e-mail programs and web browser programs loaded onto the ProtoTRAK and by using a router with a firewall. An anti-virus program is not necessary since the virus risk is low, and is not recommended because the background tasks may cause damage by interfering with ProtoTRAK real-time operation.

Microsoft Updates:

Please note that the ProtoTRAK control is not designed to be automatically downloading updates from Microsoft, or for that matter any 3rd party software. There is only a limited amount of free space on the compact flash card, and downloading files to it until it is full may result in the ProtoTRAK to stop working properly.

Also note, that administrators must exclude the ProtoTRAK from programs such as Windows Server Update Service, where the software will automatically try to download updates to the control.

14.12.1 A Basic Peer-To-Peer Network

Recommended Setup:

It is important to note that our ProtoTRAK control is not a full blown workstation. It is not designed to hook up to the internet, download Microsoft updates, or run any additional third party software in the background (not unless you want to sacrifice machine performance). It is also not able to share its contents to the rest of the network.

An ideal setup would be to purchase a router and have it connected directly to the ProtoTRAK control, and have it handle communications between it and your desktop computer. Several ProtoTRAKs can be hooked up simultaneously with minimal effort. The simplest scenario is to have the ProtoTRAK control and desktop computer both setup to:

- (a) have unique computer names
- (b) have the same workgroup name
- (c) obtain IP address automatically
- (d) share a folder on your desktop pc, and
- (e) map a network drive on your ProtoTRAK control to location of the shared folder.

Initial Setup:

The following instructions will help you set up the most basic peer-to-peer network between a ProtoTRAK PMX CNC and a computer. A peer-to-peer network simply connects two computers of equal status together.

Hardware:

1. Obtain a DSL / Cable router with DHCP services. Acceptable routers are made by Linksys and Netgear and are available at computer stores. This type of router will automatically assign IP addresses to your ProtoTRAK and computer, saving you a few steps.
2. Obtain a sufficient quantity of twisted-pair category 5 rated Network Cable. This looks like a telephone cable except slightly larger and is available at computer stores.
3. Make sure your computer has a Network Interface Card installed. This is also known as an Ethernet Port.
4. Plug both the computer and the ProtoTRAK into the router in the hub side of the router. The hub side is the side with multiple cable ports. Avoid the port that is by itself unless you really know what you are doing. The ProtoTRAK is configured to get IP addresses automatically from the router. That means that the computers are probably connected when you turn them on and plug the cables into the routers. You can confirm that the ProtoTRAK and computer are connected by looking at the lights on the front of the router. Once the connection is made you still need to do a couple more steps before the network is useful.

14.12.2 Assigning a Name and Selecting a Workgroup

No matter what kind of network you establish, you must assign a name and select a workgroup for your ProtoTRAK PMX CNC.

On The Desktop Computer You Want To Network:

There are differences in the process of setting up a network between different Windows versions. Fortunately, there are just a couple of things you need to do, and the instructions for these are already on your computer.

1. Set your computer to automatically obtain IP addresses. For instructions on how to do this, go to Windows™ Help and search for the topic IP Addresses. If the lights above the cable on the router are on, you don't have to do this.

2. Create a Workgroup name for your computer. For instructions on how to do this, go to Windows™ Help and search for the topic “Workgroup Names”. If there is a workgroup name already, write it down. We will make the ProtoTRAK match the existing name in the next steps below.
3. Share a part of your computer. This will allow the ProtoTRAK to look into the drives or folders you share. For instructions on how to do this, go to Windows™ Help and search for the topic “Sharing” or “How to Share a Folder”. In order to allow the ProtoTRAK to read and write programs to this folder, select “Full Access”.

On the ProtoTRAK PMX Control:

1. Plug a keyboard and mouse into your ProtoTRAK and turn it on. Go to the Select a Mode screen.
2. On the keyboard press simultaneously: Ctrl + Esc. This will show the Start Menu.

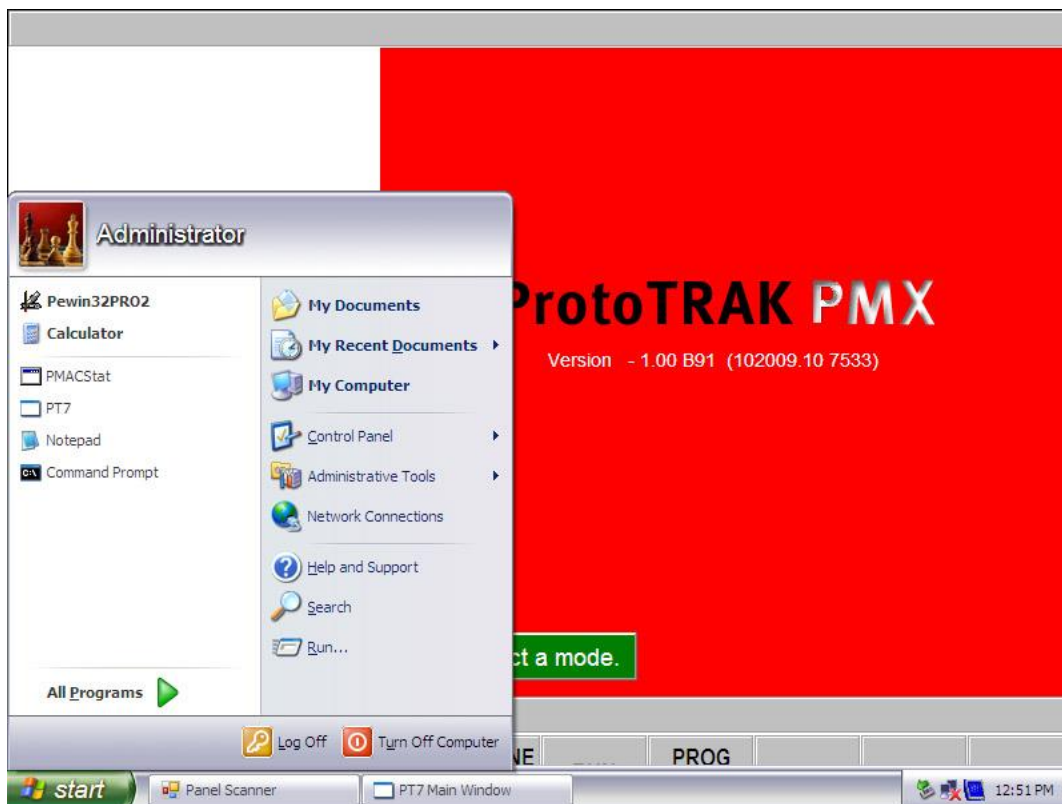

3. From the Start menu, select Control Panel.
4. Double click on the System icon
5. Select the Computer Name tab.
6. Do not enter the computer description here. Instead, click the Change button.
7. Enter a name for the ProtoTRAK PMX in the Computer Name box. We suggest something descriptive, for example “LPM1”.

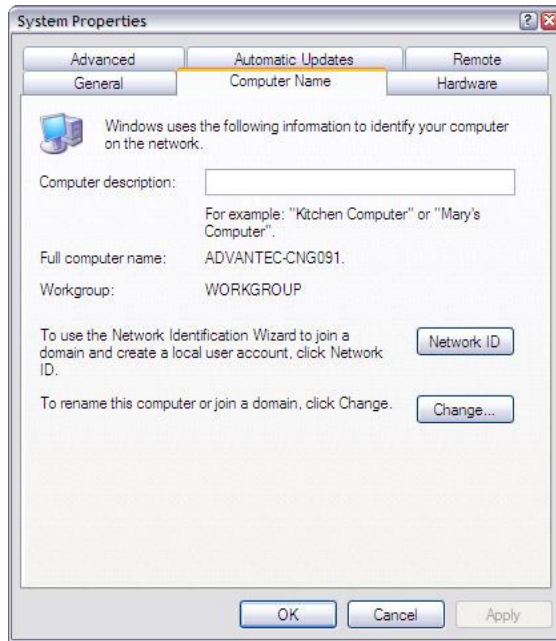

8. Enter a workgroup. This workgroup must match the name of the workgroup on your desktop computer. Assigning a workgroup name for your computer is discussed above. If you have not selected a workgroup for your computer we suggest “shop” or “toolroom”.
9. Keep clicking OK until you get back to the Select a Mode screen.
10. You may be prompted to restart the computer during this process. If so, click on YES to reboot the computer, and the changes should take effect after reboot.

14.12.3 Mapping Network Drive

On The ProtoTRAK PMX:

1. Press CTRL + ESC. Select My Computer from the Start Menu, and a window should pop up. From this window, take note of which drives letters are used, and which ones are available. USB flash drives will each take up a drive letter here. In the image below, a USB flash drive is plugged in and recognized as drive D. Drive C is the compact flash card, located in the computer module, which stores our ProtoTRAK PMX software and the Windows operation system. These drive letters will obviously not be available for use, and we will need to pick an available one to map our network drive.
2. Click on the Tools menu, and then select Map Network Drive... See image below.

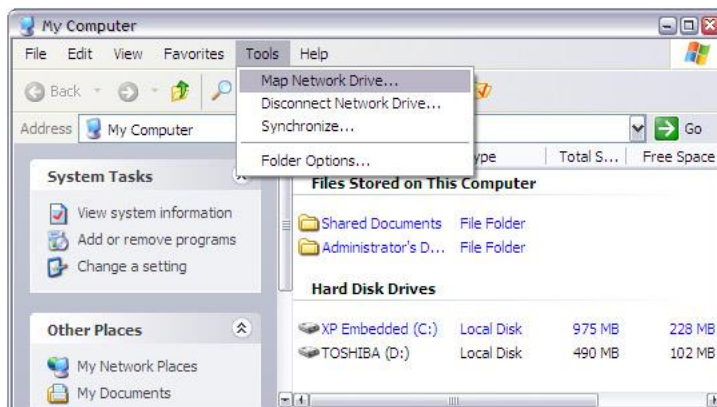

3. In the Drive box, type in an available drive letter. In our example, Drive Z is available (and more likely will be available for you as well). Type in the letters “Z:” You must type in both the “Z” and the “:”. See image below.
4. In the Folder box, Browse for the folder on your PC that you shared, from Section 14.12.2, step 3. When you click browse, you may have to go through a few layers of file hierarchy before you find the folder you shared.

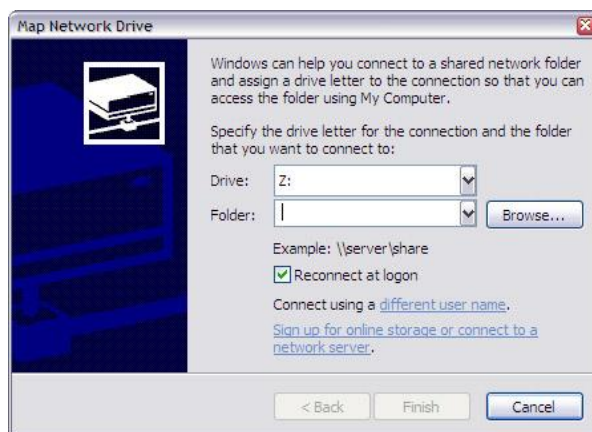

Enter Z: in the Drive box and Browse for the file you shared on your computer.

5. Make sure the option to Reconnect at logon is checked, as shown above. This assures that the mapped drive will be there the next time the computer is started.
6. Click Finish, and close out any remaining windows. The shared drive on the computer should now be accessible in the Program In/Out Mode under drive Z.

To connect other ProtoTRAKs on this simple network, repeat the process starting with assigning a name. Each ProtoTRAK must have a unique name and use the same workgroup. Note however that our ProtoTRAK controls are NOT able to share their contents with each other. Think of it as a one way street, the ProtoTRAKs are able to access regular PC's and save / retrieve files, but the reverse is not true.

14.12.4 General Information For Advanced Networks

The ProtoTRAK PMX CNC is a PC, but for setting up a network it is more useful to think of it as a device such as a printer. While the ProtoTRAK has many similarities to a desktop computer, it is different in that the use of the computer's resources have been optimized for running part programs and the resulting motor / sensor feedback in real time. In order to avoid causing a slow-down or instability in the operating system of the control, keep the following in mind when setting up the network:

- Do not use a resource-intensive networking program such as SMS. Use the Windows™ XP utilities in the ProtoTRAK PMX instead.
- Avoid loading programs that direct background tasks. Some examples are e-mail, web browsers and anti-virus programs.

Virus Protection:

As a device, ProtoTRAK CNCs are not generally susceptible to viral infections. The part “programs” they run are non-executable text files. You can further assure protection by avoiding e-mail programs and web browser programs loaded onto the ProtoTRAK and by using a router with a firewall. An anti-virus program is not necessary since the virus risk is low, and is not recommended because the background tasks may cause damage by interfering with ProtoTRAK real-time operation.

Microsoft Updates:

Please note that the ProtoTRAK PMX control is not designed to be automatically downloading updates from Microsoft, or for that matter any 3rd party software. There is only a limited amount of free space on the compact flash card, and downloading files to it until it is full may result in the ProtoTRAK to stop working properly.

Also note, that administrators must exclude the ProtoTRAK from programs such as Windows Server Update Service, where the software will automatically try to download updates to the control.

14.13 CAD/CAM and Post Processors

In addition to running G-code files, the ProtoTRAK PMX will also accept CAM files and convert them into the ProtoTRAK events. This is a great advantage as it allows you to have your CAD/CAM programmer send files to the machine that the machinist can then work with in the familiar ProtoTRAK interface. The machinist can modify the program as necessary without having to go back to the CAD/CAM programmer.

In order to be able to convert the program from a CAM system to a ProtoTRAK program the CAM program must be two or 2½ axis. A 2½-axis program is defined as a program where the Z axis is stationary while X and Y is moving. If you want to run a full three-axis program, you should run a G Code, or .GCD program (see Section 14.11).

The above 2½-axis restriction does not mean that the ProtoTRAK is not capable of running three-axis simultaneous programs written in ProtoTRAK events (as some ill-informed competitors would have you believe). This restriction is a matter of practicality. Because the ProtoTRAK allows you to program in part geometry and

therefore will figure out the tool path for you, the process of converting a three-axis program gives the ProtoTRAK a tool position problem that it cannot resolve without a lot more data from you. The other reason is that the output from a CAM systems for 3-axis shapes is in the form of thousands and thousands of straight-line G01 moves that would convert into the equal number of ProtoTRAK Mill events. This is hardly a manageable program.

Instead of forcing the issue in a silly way, we give you the more elegant solution of running GCD files. To our competitors, we respectfully point out that the thread and helix milling canned cycles of the ProtoTRAK are obvious examples of three-axis simultaneous interpolation.

In order to run a CAM program, the program must be posted through a post-processor that makes some adjustments to the output of the CAM software so that it is understood by the ProtoTRAK. The ProtoTRAK uses a post-processor that is very similar to the Fanuc 6M.

If you are not familiar with writing a post-processor, we recommend that you contact your CAD/CAM supplier. We will be happy to work with him to get you the post-processor you need.

14.13.1 Writing a Post Processor

The following are modifications to a Fanuc 6 post-processor that are necessary for writing the ProtoTRAK post-processor.

Beginning File Format: The ProtoTRAK has no special requirements; it does not need any special characters.

End Of File Format: the ProtoTRAK requires the % to show the end of the file.

Characters after the % will be ignored.

Beginning Of An Operation: the ProtoTRAK requires that the tool number, feedrate and tool offset appear before, or on the same line, as a move command. In addition, the ProtoTRAK PMX requires the spindle speed be set. The absolute zero of the ProtoTRAK is set in a different mode and does not need to be set at the beginning of each operation. The feedrate is modal, once it is set, it remains the same until changed.

Lines: the line feed (or carriage return/line feed) signals the end of the line (ASCII code hex 0A or 0D 0A). A semicolon is not needed.

Coordinates: may be formatted in inch or metric. The addresses used for specifying coordinates are X, Y, Z, I, J, K. The valid ranges are:

- Inch: min -99.9999 to max +99.9999
- Mm: min -999.99 to max +99.999

Rapid Moves: rapid moves are generated by the ProtoTRAK automatically as part of the definition of an event. For this reason, G0 moves are discarded unless they specify a location other than the beginning of the following event.

Linear Moves: G01 are formatted the same as rapid moves.

Arcs: Arc centers are specified by the address I, J and K for the X, Y and Z axes. The number following the I, J and K are incrementally referenced from the starting point of the arc. Radius values are not allowed.

Tool Numbers and Tool Changes: the format of the tool number is from T1 to T99. During program run, the ProtoTRAK will rapid to home for a tool change and pause for the tool to be loaded manually and the operator to press GO.

Feed Rates: the ProtoTRAK is programmed in inches (or mm) per minute using the 'F' address.

Spindle Speed: Defined by the 'S' address, followed by the speed in Revolutions Per Minute.

File Name: use the .CAM extension so the ProtoTRAK PMX will recognize the file as a CAM file and convert it into ProtoTRAK events when it is opened. File names may include up to 20 alpha-numeric characters.

14.13.2 Convertible G-Codes for CAM Converter

The following G-codes may be used in a CAM file that you want to have converted to a ProtoTRAK program. G Codes that are not on the list below have no correspondent operation in the ProtoTRAK events and will be ignored when the program is converted.

If a G-Code is essential to your program and you do not see it here, you can do one of two things.

1. Convert the file from CAM to ProtoTRAK and add an event to the resulting ProtoTRAK program.
2. Run the program as a GCD file (See Section 14.11).

G Code	Description	Acceptable Format	Notes
G00	Position at maximum feedrate	G00 X0.0 Y0.0 Z0.0	
G01	Linear Interpolation	G01 X0.0 Y0.0 Z-1. F15.	F = Feedrate in Inches per minute
G02	Circular Interpolation (Clockwise)	G02 X1. Y2. I0. J2.	I & J define the X and Y centerpoints respectively, incremental from the starting point of the arc.
G03	Circular Interpolation (Counter-clockwise)	G03 X2. Y0. I2. J0.	
G20	Input in Inch	G20	
G21	Input in Metric	G21	
G40	Cutter compensation cancel	G40	
G41	Cuttter compensation left	G41	
G42	Cutter compensation right	G42	
G80	Canned cycle cancel	G80	
G81	Drilling cycle, spot boring	G81 X0. Y0. Z-1. R.1 F15.	Z = final depth, R = rapid position
G82	Drilling cycle, counter boring	G82 X0. Y0. Z-1. R.1 P500 F15.	P = dwell time in milliseconds
G83	Peck drilling cycle	G83 X0. Y0. Z-1. Q.125 R.1 F15.	Q = depth of peck
G84	Tapping cycle	G84 X0. Y0. Z-2. R.1 S300 F15.	For machines with programmable spindle only. S defines RPM, Pitch = F / S
G85	Boring cycle	G85 X0. Y0. Z-1 R.1 F15.	
G86	Boring canned cycle with retract	G86 X0. Y0. Z-2. R.1 A35. Q.020 P300 F15.	A = Angle of boring head. Q = Retract distance from wall of hole

G89	Boring cycle, dwell at bottom	G89 X0. Y0. Z-1 R.1 P800 F15.	P = dwell time in milliseconds
-----	-------------------------------	-------------------------------	--------------------------------

14.13.3 Supported Addresses

CAM information is communicated through the use of ADDRESS – WORD pairs. For example in the line “N01G0X1.Y2.” N, G, X, and Y are addresses. The other information (01, 1, and 2) are Data Words. The line starts with the Address = N and the data word = 01. The N address is defined as meaning “LINE NUMBER”, therefore N01 means Line # 1, and so on.

X, Y, Z	Dimensions along the specified axis
I, J, K	Distance to arc center I = X, J = Y, K = Z.
D	Tool Diameter
M	Miscellaneous Functions
G	Preparatory Function
H	Tool Length Offset Selector (silently ignored).
N	Line Number
T	Tool Number
F	Feedrate
P	Dwell time for drill/bore canned cycles
Q	Depth of cut for drill/bore canned cycles
R	Rapid point for drill/bore canned cycles
S	Spindle Speed

14.13.4 Format Terms and Definitions

Number formats:

- A. preparatory function number, denoted <prep-func>
 1. format: dd
 2. leading 0 suppression
 3. range: 0 to 99
- B. sequence or line number, denoted <seq-number>
 1. format (independent of units): dddd
 2. leading 0 suppression
 3. range: 1 to 9999
- C. unsigned coordinate word, denoted <coord>
 1. format:
 - metric: ddddd.ddd
 - inch: dddd.dddd
 2. the "+" sign is implied and therefore may be omitted
 3. leading 0 suppression
 4. if no decimal point is given, the supplied number will be interpreted as an integer (i.e. a whole number).
 5. fractional portion is optional
 6. range:
 - metric: 0 to 99999.999
 - inch: 0 to 9999.9999

- D. signed coordinate word, denoted <scoord>
 - 1. format:
negative number: -<coord>
positive number: +<coord> or <coord>
 - 2. range:
metric: -99999.999 to 99999.999
inch: -9999.9999 to 9999.9999
- E. tool function, denoted <tool>
 - 1. format : dd (use 2-digit only)
 - 2. leading 0 suppression
 - 3. range: 1 to 99
- F. miscellaneous or M codes function number, denoted <prep-func>
 - 1. format: dd
 - 2. leading 0 suppression
 - 3. range: 1 to 99
- G. feedrate values, denoted <frate>
 - 1. format:
metric: ddddd
inch: ddd.dd
 - 2. leading 0 suppression
 - 3. decimal point not required
 - 4. fractional portion is optional
 - 5. range:
metric: 1 to 6350
inch: 0.1 to 250
- H. RPM command (VM)
 - 1. format: dddd
S1000 = 1000 RPM

14.13.5 Accepted M Codes

- | M Code | Function |
|-----------|---|
| M00 | A pause is generated. The axes will not move, but the motors will be engaged. The spindle motor will not turn off. |
| M03 | spindle on CW or FWD |
| M04 | spindle on CCW or REV |
| M06 | Tool change. The M06 is ignored, as the tool change on the ProtoTRAK is accomplished by changing the tool number. |
| M07 | Air Blast On. |
| M08 | Flood coolant on. |
| M09 | Coolant off. |
| M10 | Air Blast Off. |
| M12 & M20 | Send a pause to the indexer and wait for an “in position” response. M12 means to pulse the indexer at the beginning of an event and M20 means to pulse the indexer at the end of the event. |
| M22 | Brings the table to the part change position, useful at the end of programs. |

All other M codes will be ignored.

Notes:

1. Place M Codes on same line as movement G Code.
2. One M Code per block.
3. All values are in Absolute, except for I, J, and K values.

15.0 4th Axis Option

The 4th axis option can be retro-fitted onto your ProtoTRAK LPM machine at any time after its initial purchase. Once the option is purchased and physically installed, you can activate it on your software screen by following the instructions below:

From the main MODE screen, go to:

MACHINE SETUP
SERV CODES
A
CODE 318

A. Fourth Axis Option									
1.	AutoDesk, Inc. (AutoCad DXF)	ACAD	.DXF						
2.	Southwestern Industries, Inc.	SWI	.MX3						
3.	Southwestern Industries, Inc. (IN)	F6M	.CAM						
4.	Southwestern Industries, Inc. (GCD)	SWI	.GCD						
5.	Southwestern Industries, Inc. (OUT)	F6M	.CAM						

F1	F2	F3	F4	F5	F6	F7	F8	F9	F10
PAGE FWD	PAGE BACK	DATA FWD	DATA BACK		INSTALL				RETURN

You will enter a screen that should look like the one above. If the 4th Axis Option is not yet activated, when you press the INSTALL button, you will get the chance to do so. Simply call at the number provided on the screen, and give your unique Hardware Key Serial Number. You will then be given an activation password, which will enable the 4th axis option to be used from then on.

You may need to go to service code 509 to select the type of 4th axis unit you have. This only needs to be done 1 time.

To turn the 4th axis option on, press the follow buttons:

MODE

MACHINE SETUP
4TH AXIS ON

15.1 4th Axis Specifications

The following are the specifications for the 4th axis unit.

	201RB Model	200RB Model	SWI 8" Model
Spindle Diameter	7.874" or 200 mm	7.874" or 200 mm	8.07" or 205 mm
Chuck Diameter	7.874" or 200 mm	7.874" or 200 mm	7.874" or 200 mm
Overall Height of 4 th Axis	11.811" or 300 mm	12.79" or 325 mm	13.86" or 352 mm
Centerline Height of Spindle	5.315" or 135 mm	6.3" or 160 mm	6.30" or 160 mm
Minimum Resolution of System	0.001°	0.001°	0.001°
Maximum RPM	22	22	22
Repeatability	+/- 2 arc seconds	uni 4 arc seconds, bi 8 arc seconds	+/- 2 arc seconds
Indexing Accuracy	20 arc seconds	25 arc seconds	2 arc seconds
4 th Axis Weight	185 lbs or 84 Kg	220 lbs or 100 Kg	185 lbs or 84 Kg
4 th Axis Keyway Size	18 mm	18 mm	18 mm
Max distance between 4 th axis with chuck (without chuck) & tailstock with center	22.5" (26.25")	22.5" (26.25")	21.7" (24.7")

15.2 Definitions, Terms, and Concepts

15.2.1 Direction of 4th Axis

It is important to understand the differences in how to command the 4th axis to position in the correct direction. The figure on the left will show you the positive direction for the work coordinate system, ie the XYZ and A values that you are programming in relation to your workpiece. The figure on the right shows which direction the machine will actually move in order to get it to go in the positive direction.

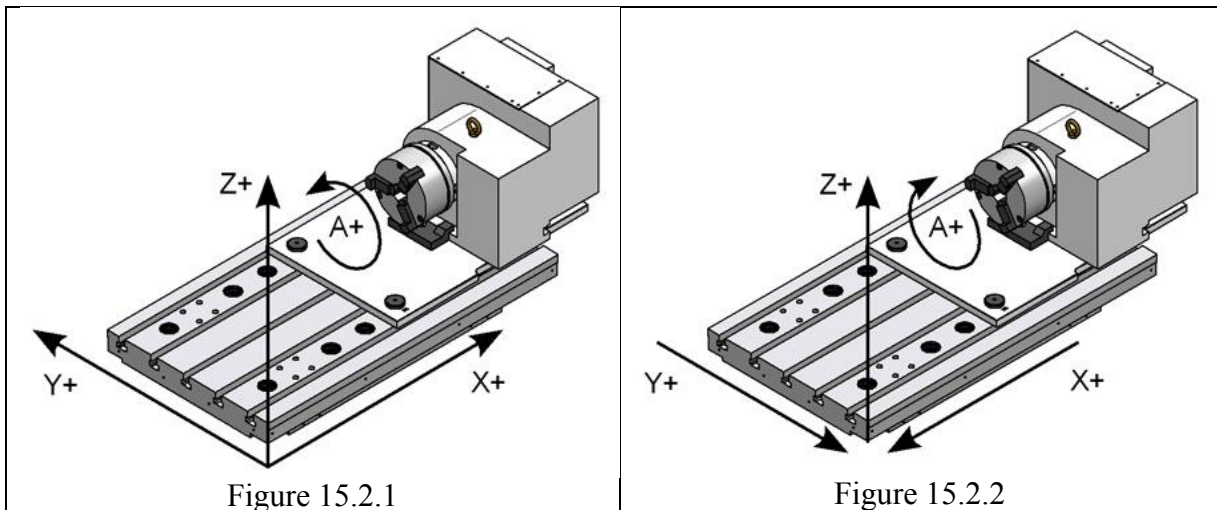

Figure 15.2.1
Work coordinates (Positive direction).

Figure 15.2.2
Table movement (Positive direction).

The 4th axis is referred to as the A axis, and is measured in degrees. On the DRO screen, it will read from 0.000 degrees to +359.999 degrees. However, when programming, you can refer to negative values, and you can use values of greater than 360 degrees.

Take a look below at figure 15.2.3. Suppose that A is our starting point, and that A equals +30 degrees ABS. If B was our desired endpoint, then there are actually 4 different ways to program this. By defining B as -30 degrees ABS, or -60 degrees INC, the system will take the shorter toolpath 1, as shown in figure 15.2.4. If we define B as +330 ABS, or +300 INC, it will take the long way around, as shown by toolpath 2. Keep in mind that this is meant for 4th axis mill events. If we were only positioning the 4th axis, it will always take the shortest path in order to save time. If you wanted a position event to purposefully take the long way around, such as to get around an obstacle, then you would need to create two position moves, each less than 180 degrees.

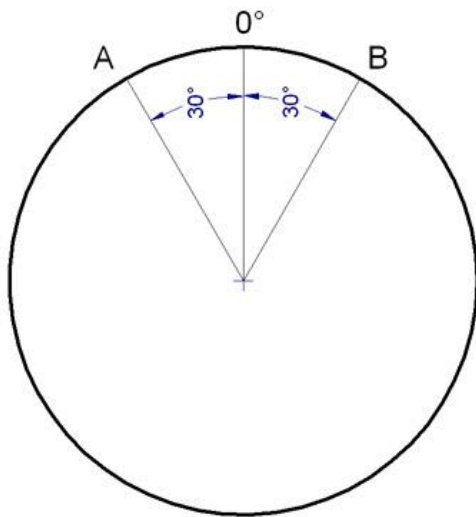

Figure 15.2.3

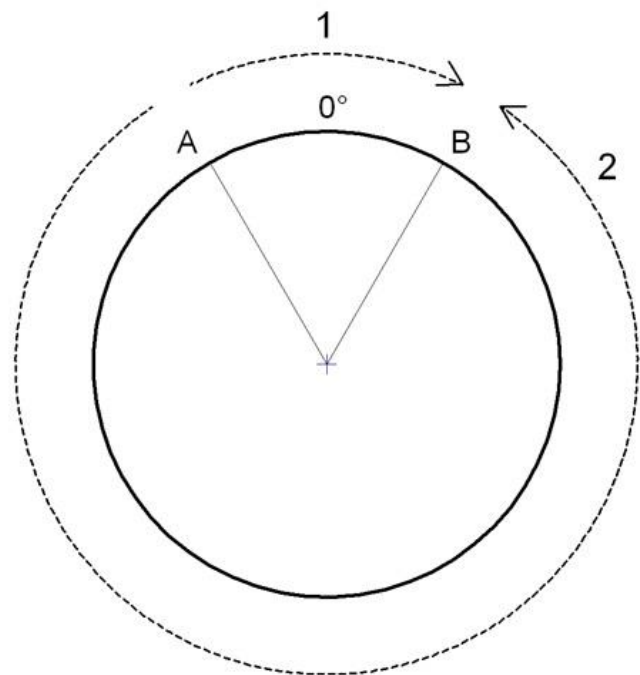

Figure 15.2.4

You are also not limited to values that are less than or equal to 360. Take a look at the next figure 15.2.5. Imagine that you wanted to cut a groove around a cylinder part, and it needed to wrap around two revolutions. You can program a start point of A 0° ABS, and an end point of A -720° ABS to achieve this (the picture shows the groove spiraling in the negative direction, refer to figure 15.2.1), while the X axis will simultaneously feed +4.00” across. For more details on how to program this part, see section 15.4.2.

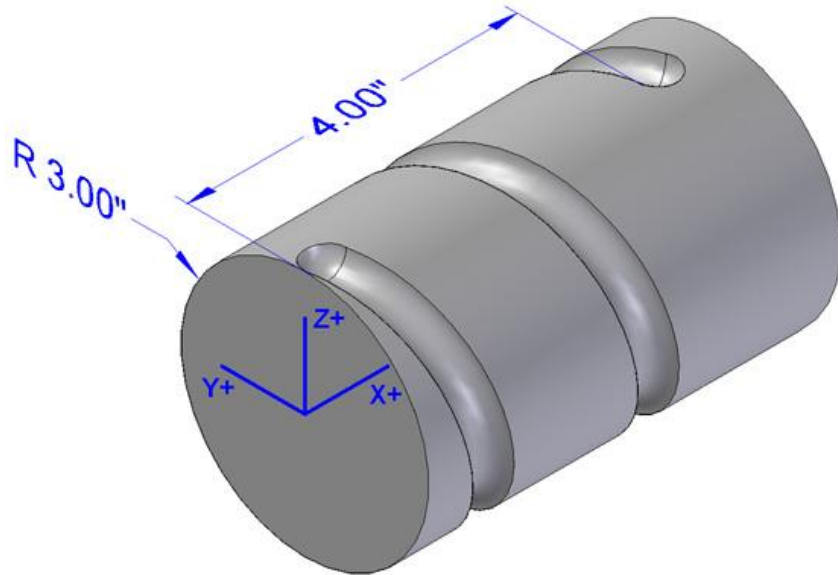

Figure 15.2.5

15.2.2 Feedrate

Feedrate for the 4th axis is always defined in inches per minute. When feeding along the A axis, the system will reference from the centerline of the 4th axis. If 20 inches per minute is defined, the system will look at the distance from the current Z axis (tip of the tool, so tool offset needs to be set properly) to the centerline of the 4th axis, and will automatically calculate how fast to turn the A axis in order to achieve the desired feedrate at the tip of the tool.

15.3 DRO Mode

When the 4th axis option is turned on, you will see an extra line for the A axis on the main readout. In addition, each of the selections in the DRO page will now have an option for the A axis.

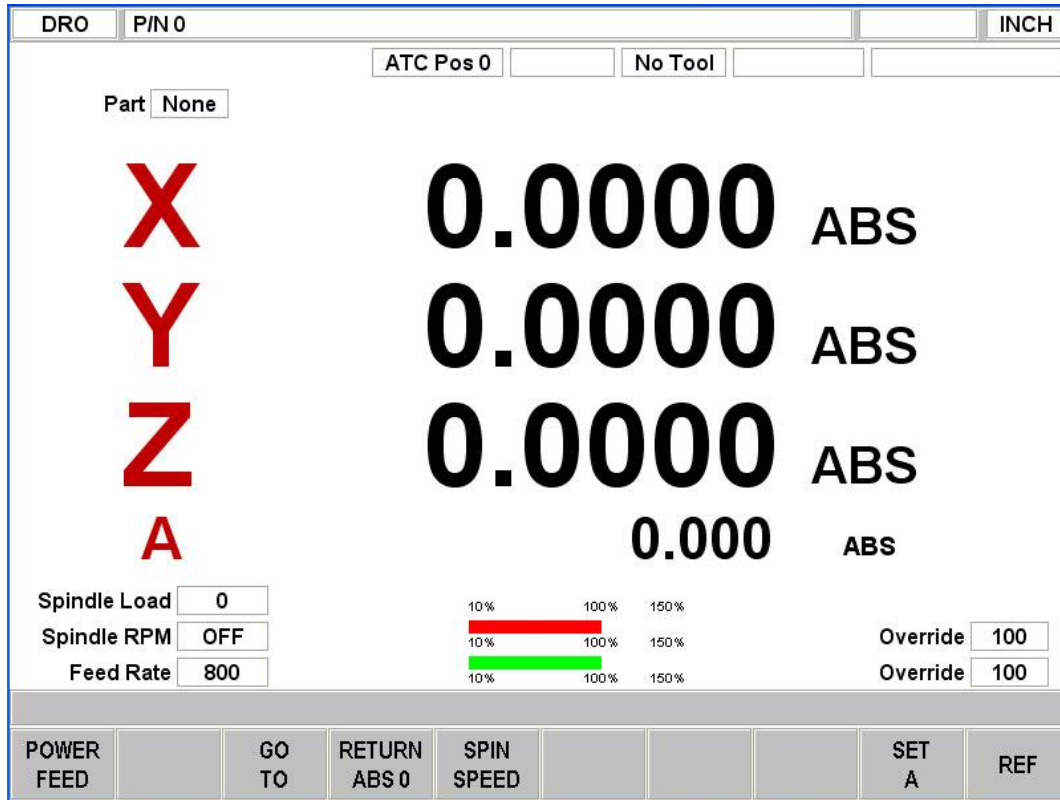

15.3.1 JOG

To JOG the 4th axis, simply press the EHW button on the Run Panel, and press the 4th button. The electronic handwheel will now jog the 4th axis in either direction.

The resolutions for the JOG speed are as follows:

- .0001" -> .001 degree per click
- .0010" -> .010 degree per click
- .0100" -> .100 degree per click
- FAST -> FAST

15.3.2 GO TO

When choosing the POSITION option under GO TO, you can now define the A axis as a position. When manually jogging to the defined A point, the axis will decelerate and then stop at the defined location.

15.3.3 RETURN ABS 0

Press RETURN ABS 0, and then GO to return to your part's abs 0 location. The A axis will move back to its 0 by taking the shortest path.

15.3.4 SET A

Press this button to set you A axis to a temporary abs value. Like the other axis, this is only for the ABS reference, and does not affect your part's abs 0 location.

15.3.5 REF 4th Axis

Press REF, and then 4TH AXIS to reference from the 4th axis. The reference points referenced here are defined in service code 506. The X represents the distance to the faceplate of the 4th axis. The Y and Z axis reference the center line of the 4th axis rotation. The A axis will reference its machine home position.

15.4 PROG Mode

Once the fourth axis is turned on in MACH SETUP mode (see section XX), the software will enable new programming options. Under the header event, set the Fourth Axis Request parameter to YES. This will enable the new events discussed below.

PROG	INCH
Program Name	00082410
Scale	1.000
Dwell Request	NO
Fourth Axis Request	YES
Event Comments	NO
Dimension Definition	PART GEOMETRY

Fourth Axis Request : YES

YES	NO		GO TO BEGIN	GO TO END	GO TO #				
-----	----	--	----------------	--------------	------------	--	--	--	--

15.4.1 POSN

PROG	P/N 00082410		INCH
EVENT 0		EVENT 1	POSITION
PROGRAM NAME	00082410	X END	0.0000 abs
SCALE	1.000	Y END	0.0000 abs
DWELL REQUEST	NO	A END	90.0000 abs
FOURTH AXIS REQUEST	YES	Z RAPID	
EVENT COMMENTS	NO	RPM	
DIMENSION DEFINITION	PART GEO	TOOL #	
A END : 90.0000 abs			
		DATA BOTTOM	INSERT EVENT
			DELETE EVENT

A END – specifies the value, in degrees, where the 4th axis will rapid to.

15.4.2 MILL 4 AXIS

The 4th axis mill event allows you to feed up to all three axis simultaneously, from any X,Z,A beginning point to any X,Z,A ending point. The Y axis is assumed to be at centerline of your part. The Z axis will be the distance from the center of your part, so think of it in terms of radius. Note that there is no cutter compensation available for 4th axis mill events.

PROG		P/N 0		INCH	
EVENT 1			EVENT 2		
POSITION			MILL 4 AXIS		
X END	0.0000	abs	X BEGIN	0.0000	abs
Y END	0.0000	abs	A BEGIN	0.0000	abs
A END	90.0000	abs	Z RAPID	2.1000	abs
Z RAPID	2.1000	abs	Z BEGIN	1.7500	abs
RPM	3500.00		X END	2.0000	abs
TOOL #	1		A END	10.0000	inc
			Z END	0.0000	inc
			RPM	3500.00	
			Z FEEDRATE	10.0	
			XAZ FEEDRATE	25.0	
			TOOL #	1	
? TOOL # : 1					
DATA		INSERT		DELETE	
BOTTOM		EVENT		EVENT	

A BEGIN – Specifies the beginning angle of the mill event.

A END – Specifies the ending angle of the mill event.

XAZ FEEDRATE – Specifies the feedrate of the tip of the tool, in relation to the surface of the workpiece. The feedrate will only be accurate if the part is properly set in the Part/Fixture Mgmt page (see section 15.5.1).

15.4.3 ENGRAVE 4 AXIS

The 4th axis engrave event assumes that you have cylindrical stock, and want to engrave along the surface.

PROG	P/N 0		INCH
EVENT 2		MILL 4 AXIS	
X BEGIN	0.0000	abs	
A BEGIN	0.0000	abs	
Z RAPID	2.1000	abs	
Z BEGIN	1.7500	abs	
X END	2.0000	abs	
A END	10.0000	inc	
Z END	0.0000	inc	
RPM	3500.00		
Z FEEDRATE	10.0		
XAZ FEEDRATE	25.0		
TOOL #	1		
EVENT 3		ENGRAVE 4 AXIS	
X BEGIN	0.0000	abs	
A BEGIN	100.0000	abs	
Z RAPID	2.1000	abs	
Z END	1.7500	abs	
HEIGHT	0.5000		
TEXT	PN 24		
AXIAL/RADIAL	AXIAL		
RPM	3500.00		
Z FEEDRATE	10.0		
XAZ FEEDRATE	25.0		
TOOL #	1		
X BEGIN : 0.0000 abs			
		DATA BOTTOM	INSERT EVENT
		DELETE EVENT	

X BEGIN – Defines the starting point on the X axis for the text to be engraved. See figure 15.3.3, and note that even though both radial and axial have the same XA starting point, they span across different areas along the X axis.

A BEGIN – Defines the angle for the starting point of the text to be engraved. See figure 15.3.3 for a visual of both radial and axial text that have the same XA starting point.

Z END – Determines the depth at which the engraving will take place. This distance will be the radius of the part, assuming you have a cylinder stock.

HEIGHT – Defines of the height of the letters, if they were unwrapped onto a flat surface.

AXIAL / RADIAL – Determines which direction the text will wrap around your cylindrical part. See figure 15.4.3.

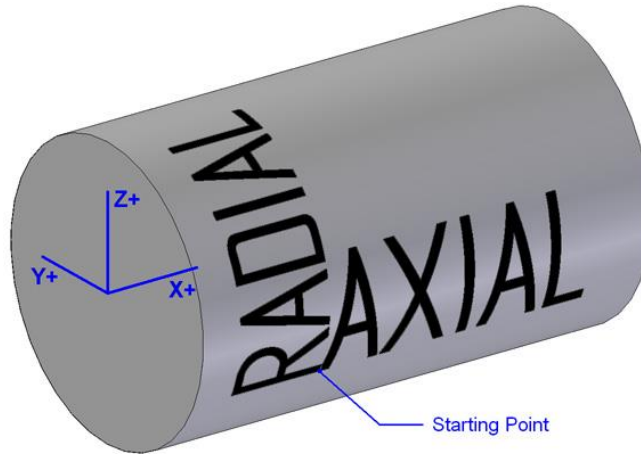

Figure 15.4.3

15.4.4 AUX Event

PROG	P/N 0			INCH
EVENT 0		EVENT 1	AUX	
PROGRAM NAME	0	AUX	NONE	
SCALE	1.000			
DWELL REQUEST	NO			
FOURTH AXIS REQUEST	YES			
EVENT COMMENTS	NO			
DIMENSION DEFINITION	PART GEO			
<div style="background-color: green; color: white; padding: 5px;"> 0 - NONE 1 - Coolant ON 2 - Air ON 3 - Coolant OFF 4 - Air OFF 5 - Pulse Indexer 6 - Part Change Position 7 - 4th Axis Auto-Clamp OFF 8 - 4th Axis Auto-Clamp ON </div>		<p>Note that AUX 5 (Pulse Indexer) is no longer an option when you enable Fourth Axis Request.</p>		
		AUX : NONE		
		DATA BOTTOM	INSERT EVENT	DELETE EVENT

Two new AUX event options will become available when you have turned on Fourth Axis Request in the header event. Select 7 for Auto Clamp OFF and select 8 for Auto Clamp ON. By default the 4th axis will automatically clamp the A axis in place when it is holding position and will automatically unclamp the axis when an A axis move is commanded. It should be noted that there is a slight delay when the unit is going from a

clamped to unclamp state. This means if you have a connective move from let's say the X axis to the A axis, you are going to want to program an Aux 7 prior to the X axis event so the unit will not clamp and hence delay slightly before moving into the A axis move. The auto-clamping feature is useful when you are simply indexing the 4th axis from one A position to another. We also recommend you program an Aux 7 when you are going to be doing engraving or contouring type work so the 4th axis will not clamp. When running a G code program, you will need to use M codes M11 and M12 to control the clamping and unclamping function. See section 14.11.1 & 14.11.2 for a list of supported G and M codes.

15.4.5 LOOK

Program LOOK when using the 4th axis has 1 new feature that is call ROTATE ON or OFF. This feature when selected to ON allows the graphics to rotate the part about the A axis when viewing the program from LIST STEP. The feature or surface in question will be highlighted in purple and be rotated so it will be shown as being perpendicular to where the cutting tool would make contact with the part. This feature makes it easier to see the details of your part when you have programmed multiple A axis surfaces.

Pressing the ROTATE ON/OFF button toggles this feature between ON and OFF. For example, when this button reads ROTATE OFF on the screen, it means the graphics will ROTATE each time you press the LIST STEP button. Pressing this button again will turn off the ROTATE feature and the button will read ROTATE ON.

15.5 PROG SETUP Modes

15.5.1 PART/FIX MGMT Screen

PROG SIU	P/N 00082410		INCH
ATC Pos 0		No Tool	
Part/Fixture Management			
Part	1		
P/N	00082410		
Fixture Location	4TH		
Fixture Number	1		
X Offset	-4.0000		
Y Offset	0.0000		
Z Offset	0.0000		
A Offset	0.0000		
Parts/Fixture	1		
X Shift	0.0000		
Y Shift	0.0000		
Z Shift	0.0000		

X	-4.0000	4TH
Y	9.0000	4TH
Z	12.7340	4TH
A	0.000	4TH

A OFFSET :		0.0000
------------	--	--------

PICTURE	NOTES	GO TO	Z SAFETY			SPIN SPEED		RETURN
---------	-------	-------	----------	--	--	------------	--	--------

There are a few new features available on this screen when the 4th axis option is enabled.

Fixture Location – The user can now select the 4th axis as a reference point from which his offsets will be saved. The X axis is referenced from the face of the 4th axis, the Y and Z axis are both relative to the center of rotation about the 4th axis. The A axis will be referenced from its machine home position.

A Offset – Sets the offset between the 4th axis home position, and the desired ABS 0 position that you want to work from. See figures below for a sample of how this works.

Mini DRO – The mini DRO in the bottom left corner now displays a live update of the current 4th axis position, relative to home.

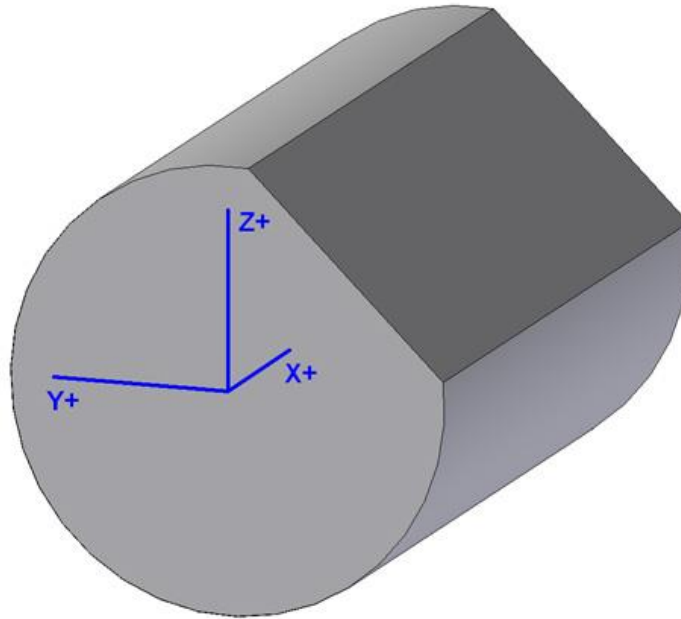

Figure 15.5.1.1

If you were to take the solid part pictured above and mount it into the 4th axis jaws, you would more than likely tram in the flat side with an indicator assuming that you wanted to machine relative to that surface. The A offset will compensate for the distance between where the A Home position is and where you want your ABS A Zero to be.

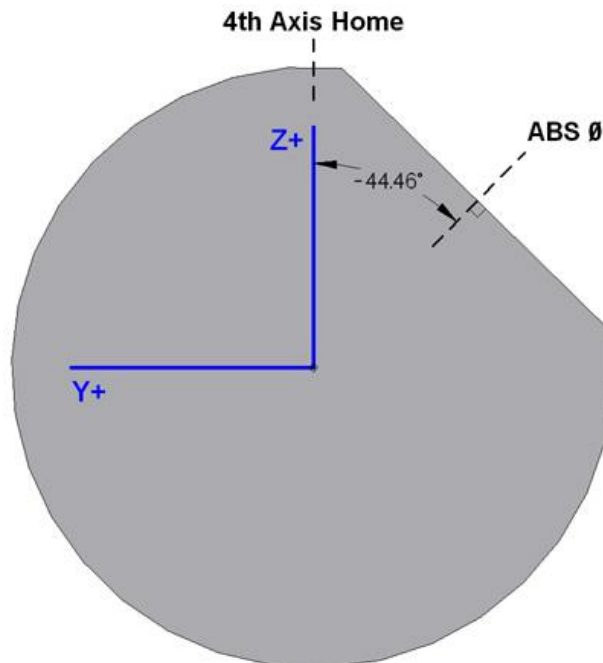

Figure 15.5.1.2

Say for example that after tramping in the flat surface, the DRO for the A axis read 315.54 degrees ($360 - 44.46 = 315.54$). You would simply type in that value for the A

offset, so that when the program is commanded to position to ABS Zero, it will move to that spot that you defined.

As a rule of thumb, if you are going to be working on round stock as shown above, you should make it so that Y ABS zero and Z ABS zero remains at the centerline of your part. For our 4th axis engraving and 4th axis mill events, this is a must. Therefore, every Z value that is to be programmed, will be referring to the radius of the part. If however, you will be working on a square part or something that only needs to be indexed, then you can set your Y and Z ABS zero wherever is more convenient to you.

15.5.2 Tool Path

The tool path viewer will now rotate the part about the A axis as you use the STEP feature. The feature or surface in question will be rotated so it will be shown as being perpendicular to where the cutting tool would make contact with the part. This feature makes it easier to see the details of your part when you have programmed multiple A axis surfaces.

15.6 MACHINE SETUP Mode

15.6.1 SERV CODES Screen

The following new service codes have been modified or added to the PMX control for the 4th axis unit. For more information on some of the service codes, see the LPM Service Manual.

1. Service Code 318 – used to turn on the 4th axis option software. See section 15.0.
2. Service Code 128 – add the ability to compensate for A axis backlash. Value entered in decimal degrees. See service manual for more information.
3. Service Code 505 – added a prompt for the A axis motor index
4. CODE 506: Set 4th Axis Offsets

The following service code sets the X, Y, Z and A offsets for the 4th axis unit. The follow describes what each offset is.

1. X Offset - the distance along the X axis from the face of the 4th axis to the center of ball lock C.
2. Y Offset - the distance along the Y axis from the centerline of the 4th axis to the center of ball lock C. The Y offset should be set to 6.0000” based on how the 4th axis is keyed to the ball lock plate.
3. Z Offset – the distance along the Z axis from the top of the table to the centerline of the 4th axis.
4. Home Offset – the offset in degrees you need to enter to get the 4th axis vernier dial to line up with the marker on the 4th axis casting.

See the LPM service manual for how to set the Z offset location.

15.6.2 4TH AXIS ON / OFF

This soft key enables and disables the use of the 4th axis servo, as well as the programming options available to the user. When turning on the 4th axis, you will need to home the machine again so that the 4th axis gets homed as well. If the 4th axis option is turned off, you will get a prompt stating that you will lose your current program in memory.

15.7 PROG I/O

If opening a program that contains 4th axis specific events, and the 4th axis option is not activated on the machine, the system will give an error message. You must enable the option under service code 318 (see section 15.0). If the 4th axis option is turned off, and a program containing 4th axis events is opened, the system will automatically turn it on for you.

15.7.1 4th Axis G-Code notes

The ProtoTRAK PMX is capable of running 4th axis G-Code. In addition to all the codes found under section 14.11.1, please use the additional notes below when trying to define your post processor.

1. The 4th axis is defined by A, and is always assumed to be parallel to the X axis.
2. Only G00 and G01 commands support movement along the A axis. The format will look like the following:
G00 X1.0 Y2.0 Z3.0 A4.0
G01 X5.0 Y6.0 Z7.0 A8.0
3. The feedrate along A must be defined in inches per minute. Feedrate is calculated in relation to the centerline of the part, which our system is always keeping track of using service code 506.
4. M10 – Turn ON Auto Clamp for 4th axis (default). With the Auto Clamp turned ON, the 4th axis will automatically clamp when the A axis is not programmed to move. When the A axis needs to position or feed, it will automatically unclamp before doing so.
M11 – Turn OFF Auto Clamp for 4th axis. Turns off the behavior described above, and will remain unclamped during RUN mode.
5. For best results when running GCD, the Z axis g-code should be output in relation to center of part. Use a 0.0 offset for Z in the part/fix management table.
6. The angle for A axis can be defined in incremental or absolute values, using G90 / G91, can be positive or negative, and can exceed 360.
7. G41 and G42 are not supported when feeding along the 4th axis. G40 must be used.

15.8 4th Axis Setup Notes

1. Please see section 8 of the LPM service manual for important tips for taking the 4th axis unit on and off of the machine when not in use. The 4th axis unit and ball lock plate weighs about 250 lbs so please use a lift to remove the unit from the machine. This plate can be removed by sliding it onto a LPM fixture cart. The 4th axis unit also comes with an eyebolt that can be used for lifting purposes. You will also need to disconnect a power cable and air line before removing the unit.
2. The 4th axis comes with a standard 3 jaw chuck and adaptor plate. If you need to remove this chuck, please see the service manual for instructions. It should be noted that the adaptor plate and chuck will need to be trammed in when it is put back on.
3. The tailstock ball lock plate has been designed so you can mount the tailstock in different locations along the plate's length. (2) 5/8-11 bolts are used to fasten the tailstock down to the ball lock plate.

Southwestern Industries, Inc

TRAK Warranty Policy

Warranty

TRAK products are warranted to the original purchaser to be free from defects in work-manship and materials for the following periods:

Product	Warranty Period	
	Materials	Factory Labor
New TRAK/ProtoTRAK	1 Year	1 Year
Any EXCHANGE Unit	90 Days	90 Days

The warranty period starts on the date of the invoice to the original purchaser from Southwestern Industries, Inc. (SWI) or their authorized distributor.

If a product, subsystem or component under warranty fails, it will be repaired or exchanged at our option for a properly functioning unit in similar or better condition. Such repairs or exchanges will be made FOB Factory/Los Angeles or the location of our nearest factory representative or authorized distributor.

Disclaimers of Warranties

- This warranty is expressly in lieu of any other warranties, express or implied, including any implied warranty of merchantability or fitness for a particular purpose, and of any other obligations or liability on the part of SWI (or any producing entity, if different).
- Warranty repairs/exchanges do not cover incidental costs such as installation, labor, freight, etc.
- SWI is not responsible for consequential damages from use or misuse of any of its products.
- TRAK products are precision mechanical/electromechanical/electronic systems and must be given the reasonable care that these types of products require.
- Accidental damage, beyond the control of SWI, is not covered by the warranty. Thus, the warranty does not apply if a product has been abused, dropped, hit or disassembled.
- Improper installation by or at the direction of the customer in such a way that the product consequently fails, is considered to be beyond the control of the manufacturer and outside the scope of the warranty.