

TRAK[®] KMX Knee Mill, Retrofit & Upgrade

Safety, Programming, Operating and Care Manual

Document:	P/N 29831
Version:	112723

Covers Current Models:

- **TRAK K3KMX with 2-Axis CNC**
- **TRAK K3KMX with 3-Axis CNC**
- **Retrofits**
 - **PTKMX2**
 - **PTKMX3**
- **Upgrades**
 - **MX2 To KMX2 Upgrade**
 - **MX2 To KMX3 Upgrade**
 - **MX3 To KMX3 Upgrade**
 - **M2 To KMX2 Upgrade**
 - **M2 To KMX3 Upgrade**
 - **M3 To KMX3 Upgrade**
 - **AGE2 To KMX2 Upgrade**
 - **AGE2 To KMX3 Upgrade**
 - **AGE3 To KMX3 Upgrade**
 - **EDGE2 To KMX2 Upgrade**
 - **EMX To KMX2 Upgrade**

TRAK MACHINE
TOOLS



SOUTHWESTERN INDUSTRIES, INC.

2615 Homestead Place
Rancho Dominguez, CA 90220-5610 USA
T | 310.608.4422 | F | 310.764.2668
Service Department: 800.367.3165

e-mail: sales@trakmt.com | service@trakmt.com | web: www.trakmt.com

Copyright © 2020, Southwestern Industries, Inc. All rights are reserved. No part of this publication may be reproduced, stored in a retrieval system, or transmitted, in any form or by any means, mechanical, photocopying, recording or otherwise, without the prior written permission of Southwestern Industries, Inc.

While every effort has been made to include all the information required for the purposes of this guide, Southwestern Industries, Inc. assumes no responsibility for inaccuracies or omission and accepts no liability for damages resulting from the use of the information contained in this guide.

All brand names and products are trademarks or registered trademarks of their respective holders.

Southwestern Industries, Inc.
2615 Homestead Place
Rancho Dominguez, CA 90220
Phone 310-608-4422 ◆ Fax 310-764-2668
Service Department
Phone 800-367-3165 ◆ Fax 310-886-8029

Table of Contents

1.0	Introduction	1
1.1	Models	1
1.2	Manual Organization Notes	2
2.0	Safety	3
2.1	Safety Publications	3
2.2	Danger, Warning, Caution, and Note Labels and Notices As Used In This Manual	3
2.3	Safety Precautions	6
3.0	Description	8
3.1	ProtoTRAK KMX CNC Specifications	8
3.1.1	Basic System Specifications	8
3.2	Display Pendant	10
3.2.1	Front	10
3.2.2	Pendant Back Panel	12
3.2.3	Servo Motors/Amplifiers	13
3.2.4	Ballscrews	13
3.3	TRAK Knee Mill Specifications	14
3.3.1	Manual Lubrication System – K3KMX	17
3.3.2	Auto Lube System – K3KMX Option	17
3.3.3	Electrical Cabinet (TRAK Knee Mills Only)	18
3.4	Optional Equipment	19
3.4.1	Power Draw Bar	19
3.4.2	Remote Stop Go Switch	19
3.4.3	Work Light (TRAK Knee Mills Only)	19
3.4.4	Coolant Pump (TRAK Knee Mills Only)	19
3.4.5	Spray Coolant (TRAK Knee Mills Only)	19
3.4.6	Chip Pan (TRAK Knee Mills Only)	19
3.4.7	Table Guard (TRAK Knee Mills Only)	19
3.4.8	USB Thumb Drive	19
3.4.9	Electronic Handwheels	20
3.4.10	Position Encoders	20
3.4.11	Limit Switches	20
3.4.12	Cable Breakout Box	20
3.4.13	Offline Programming	20
4.0	Basic Operation	21
4.1	ProtoTRAK KMX Basic Operation.	21
4.1.1	Switching the ProtoTRAK KMX CNC on and off	21
4.1.2	Screen saver	21
4.1.3	Switching Between two and Three-Axis Operation	21
4.1.4	Modes	21

4.1.5	Emergency Stop	22
4.2	Machine Operation	22
4.2.1	Spindle On/Off, Forward/Reverse	22
4.2.2	Table, Saddle, Knee and Column Gib Locks	24
4.2.3	Raising/Lowering the Knee	Error! Bookmark not defined.
4.2.4	Spindle Brake	24
4.2.5	Draw Bar	24
4.2.6	High-Low-Neutral Level	24
4.2.7	Speed Changes	25
4.2.8	Operating the Quill	25
4.2.9	Adjusting the Quill Stop	25
4.2.10	Power Feed Engagement Lever	26
4.2.11	Fine Feed Direction Shaft	26
4.2.12	Quill Feed Selector	27
4.2.13	Feed Trip Lever	27
4.2.14	Fine Hand Quill Feed	27
4.2.15	Fine Automatic Quill Feed	27
4.3	Three-Axis Changes to the Head	27
4.4	Coolant Pump / Spray Coolant	28
5.0	Definitions, Terms & Concepts	29
5.1	ProtoTRAK KMX Axis Conventions	29
5.2	Part Geometry and Tool Path Programming	29
5.3	Planes and Vertical Planes	30
5.4	Absolute & Incremental Reference	30
5.4.1	Some Rules for Incremental Reference Positions	30
5.5	Referenced and Non-Referenced Data	31
5.6	Tool Diameter Compensation	32
5.7	Tool Diameter Compensation when Contouring in Z with Part Geometry	32
5.8	Connective Events	34
5.9	Conrad	34
5.10	Memory and Storage, Virus Protection, Microsoft Updates	34
6.0	Using the ProtoTRAK KMX as a DRO	36
6.1	Enter DRO Mode	36
6.2	DRO Functions	36
6.3	Jog	37
6.4	Return to Absolute Zero	37
6.5	Teach	38
6.5.1	Entering Teach Data	38
6.6	GO TO (TRAKing / Electronic Handwheel Option)	39
6.7	Tool #	39
6.8	Power Feed	39
7.0	Programming	41
7.1	Enter Program Mode and Assign a Program Name	41

7.1.1	General Programming Options	41
7.1.2	Auxiliary (AUX) Functions	42
7.2	Programming Strategy and Procedures	44
7.3	Programming Events – (2 axis mode)	45
7.3.1	Posn Drill	45
7.3.2	Mill Event	45
7.3.3	Arc Event	46
7.3.4	Pocket Event	46
7.3.5	Profile Event	46
7.3.6	Subroutine Events	47
7.3.7	Finishing Teach Events	49
7.4	Programming Events – (3-axis mode)	49
7.4.1	Posn Drill	49
7.4.2	Mill Event	50
7.4.3	Arc Event	50
7.4.4	Pocket Event	50
7.4.5	Profile Event	50
7.4.6	Subroutine Events	50
7.4.7	Finishing Teach Events	50
7.5	Prompts Used to Define the Events	50
7.6	Assumed Tool Offset, Feedrate, and Tool #	52
7.7	Incremental Reference Position	53
7.8	Finish Cuts	53
7.9	Look	53
8.0	Program Mode - The Auto Geometry Engine (A.G.E.) Programming	55
8.1	Starting the A.G.E.	55
8.2	A.G.E. Mill Prompts	56
8.3	A.G.E. Arc Prompts	57
8.4	Skipping Over Prompts	57
8.5	The OK/NOT OK Flag	58
8.6	Ending A.G.E.	58
8.7	Guessing Data	58
8.8	Calculated Data	59
8.9	Arcs and Conrads	59
8.10	Tangency	59
9.0	Changing or Correcting Programs	60
9.1	Deleting a Partially Programmed Event	60
9.2	Editing Data while Programming an Event	60
9.3	Editing Previously Programmed Events	60
9.4	Changing a Part Number (making a copy of a program)	60
9.5	Saving Changes to a Program	61
9.6	Erasing an Entire Program	61
10.0	SET UP/RUN Mode	62

10.1	TOOL TABLE	62
10.2	TOOL PATH	63
10.3	Setting Home	65
10.4	STEP UP & STEP DOWN – 3-Axis Mills in 2-Axis Mode	65
10.5	Verify	66
10.6	Service Codes	66
11.0	Program Run Mode	67
11.1	Setting Up	67
11.2	Starting	67
11.3	Display Messages in Program Run	67
11.4	Program Run Prompts	69
11.5	Stop	69
11.6	Feedrate Override	69
11.7	TRAKing / Electronic Handwheel Option	69
	11.7.1 TRAKing in Two-Axis CNC	70
11.8	Data Errors	70
11.9	Fault Messages	70
12.0	Program Memory & Storage	71
12.1	Cautions About Opening and Deleting Programs	71
12.2	Program Formats and Labeling	72
12.3	Opening a Program from the ProtoTRAK KMX Thumb Drive	72
	12.3.1 Open Temp	73
12.4	Saving a Program Onto the ProtoTRAK KMX Thumb Drive	73
	12.4.1 Save Temp Procedure	74
12.5	Deleting a Program on Your ProtoTRAK KMX Thumb Drive	74
12.6	Erase Current Program	74
12.7	Thumb Drive	75
12.8	Opening and Running G-Code and CAM Files	75
12.9	Networking	76
13.0	Math Help	83
13.1	Procedure	83
13.2	Math Help Types	85
14.0	Service Codes	86
	TRAK Warranty Policy	89

1.0 Introduction

Congratulations! Whether you bought the ProtoTRAK KMX CNC as a retrofit or as the CNC integrated into the TRAK Knee Mill or TRAK Bed Mill, you have an excellent toolroom machine. The ProtoTRAK KMX has an easy-to-use interface and features that make knee and bed mill work faster and more productive.

Manual Machining is always available and made easier with features like power feed, 100 inch per minute rapids, and all the best features of sophisticated DRO's.

Two-Axis or Three-Axis Machining is available at the touch of a button for the prototyping and moderately complex, low volume work that is typically done on knee mills or bed mills.

The operation of the ProtoTRAK KMX CNC has been painstakingly refined to bring you the most useful CNC technology while retaining the ease of use that has made ProtoTRAK the top brand in controls for low volume production.

This manual will describe the operation of all basic and optional features in the appropriate context. Where optional features are discussed, a note will explain in which option the particular feature is found.

1.1 Models

The ProtoTRAK KMX CNC is featured in the following products:

Model	Description
Retrofits	
PTKMX	Two-axis CNC retrofit to your knee mill
Knee Mill	
TRAK-K3KMX	Two-axis CNC, 33" x 15.5," 3 HP
TRAK-K3KMX-3	Three-axis CNC, 33" x 15.5," 3 HP

Non-Current Upgrade Applications

ProtoTRAK MX 2-axis To KMX 2 or 3-axis

ProtoTRAK MX 3-axis To KMX 3-axis

ProtoTRAK M 2-axis To KMX 2 or 3-axis

ProtoTRAK M 3-axis To KMX 3-axis

TRAK AGE 2-axis To KMX 2 or 3-axis

TRAK AGE 3-axis To KMX 3-axis

ProtoTRAK EDGE 2-axis To KMX 2-axis

ProtoTRAK EMX 2-axis To KMX 2-axis

1.2 Manual Organization Notes

This manual covers the operation of the retrofit, TRAK Knee Mill and Upgrade products that use the ProtoTRAK KMX CNC.

Some Sections do not apply to all users. For example, if you own a ProtoTRAK retrofit, you should skip the sections that cover the description and operation of TRAK K Mills.

Sections that may not apply to all users contain a note to inform you of this fact.

Section 2 of this manual provides important safety information. It is highly recommended that all operators of this product review this safety information carefully.

2.0 Safety

The safe operation of your knee or bed mill depends on its proper use and the precautions taken by each operator.

- Read and study this manual. Be certain every operator understands the operation and safety requirements of this machine *before* its use.
- Always wear safety glasses and safety shoes.
- Always stop the spindle and check to ensure the CNC control is in the stop mode before changing or adjusting the tool or workpiece.
- Never wear gloves, rings, watches, long sleeves, neckties, jewelry, or other loose items when operating or around the machine.
- Use adequate point of operation safeguarding. It is the responsibility of the employer to provide and ensure point of operation safeguarding per OSHA 1910.212 - Milling Machine.

2.1 Safety Publications

Refer to and study the following publications for assistance in enhancing the safe use of this machine.

Safety Requirements For The Construction, Care And Use of Drilling, Milling, and Boring Machines (ANSI B11.8-2001). Available from The American National Standards Institute, 1430 Broadway, New York, New York 10018.

Concepts And Techniques Of Machine Safeguarding (OSHA Publication Number 3067). Available from The Publication Office - O.S.H.A., U.S. Department of Labor, 200 Constitution Avenue, NW, Washington, DC 20210.

2.2 Danger, Warning, Caution, and Note Labels and Notices As Used In This Manual

DANGER - Immediate hazards that **will** result in severe personal injury or death. Danger labels on the machine are red in color.

WARNING - Hazards or unsafe practices that *could* result in severe personal injury and/or damage to the equipment. Warning labels on the machine are orange in color.

CAUTION - Hazards or unsafe practices that *could* result in minor personal injury or equipment/product damage. Caution labels on the machine are yellow in color.

NOTE - Call attention to specific issues requiring special attention or understanding.



ALWAYS WEAR SAFETY GLASSES AND SAFETY SHOES

ALWAYS STOP THE SPINDLE AND CHECK TO ENSURE THE CNC CONTROL IS IN THE STOP MODE BEFORE CHANGING OR ADJUSTING THE TOOL OR WORKPIECE

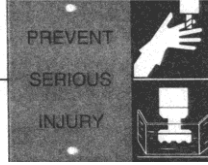

PREVENT SERIOUS INJURY

NEVER WEAR GLOVES, RINGS, WATCHES, LONG SLEEVES, NECKTIES, JEWELRY OR OTHER LOOSE ITEMS

USE ADEQUATE POINT OF OPERATION SAFEGUARDING. IT IS THE RESPONSIBILITY OF THE EMPLOYER TO PROVIDE AND ENSURE POINT OF OPERATION SAFEGUARDING. (OSHA 1910.212 MILLING MACHINES)



SOUTH WESTERN INDUSTRIES 
 2615 HOMESTEAD PLACE,
 RANCHO DOMINGUEZ, CA 90220

MODEL
 S/N

ELECTRICAL RATINGS:
 VOLTS AMPS PHASE
 Hz

FLA OF LARGEST MOTOR AMPS
 SHORT CIRCUIT INTERRUPT AMPS
 ELECTRICAL DRAWING #:

CNC CONTROL ELECTRICAL RATINGS:
 IF APPLICABLE
 115 VOLTS 8 AMPS 1 PHASE
 60 Hz

MACHINE (ONLY) MADE IN "XXXXXX"

i01158

Safety & Information Labels Used On The TRAK Knee or Bed Mills*

It is forbidden by OSHA regulations and by law to deface, destroy or remove any of these labels

*Retrofit customers: please see the manual that came with your machine for information about safety and information labels.



HIGH VOLTAGE

208/480 VOLTS

WARNING

IMPROPER INSTALLATION OR OPERATION OF THIS MOTOR MAY CAUSE INJURY TO PERSONNEL OR MOTOR FAILURE. READ OPERATING INSTRUCTIONS.

MOTOR MUST BE INSTALLED AND GROUNDED PER LOCAL AND NATIONAL ELECTRICAL CODES.

TO REDUCE POTENTIAL OF ELECTRICAL SHOCK DISCONNECT ALL POWER SOURCES BEFORE INITIATING ANY MAINTENANCE OR REPAIRS.

KEEP FINGERS AND FOREIGN OBJECTS AWAY FROM VENTILATION AND OTHER OPENINGS. KEEP AIR PASSAGES CLEAR.

EYEBOLTS OR LIFTING HOOKS, WHEN SUPPLIED, ARE INTENDED FOR LIFTING THE PRODUCT ONLY AND MUST NOT BE USED TO LIFT ADDITIONAL WEIGHT.

USE ONLY GRADE 5 SHOULDER EYEBOLTS WITH MINIMUM THREAD LENGTH OF 1 1/2 TIMES DIAMETER.

Safety & Information Labels Used On The ProtoTRAK KMX CNC

It is forbidden by OSHA regulations and by law to deface, destroy or remove any of these labels

2.3 Safety Precautions

1. Do not operate this machine before the **ProtoTRAK KMX CNC Safety, Installation, Maintenance, Service and Parts List Manual**, and the **Safety, Programming, Operating & Care Manual** have been studied and understood.
2. Do not run this machine without knowing the function of every control key, button, knob, or handle. Ask your supervisor or a qualified instructor for help when needed.
3. Protect your eyes. Wear approved safety glasses (with side shields) at all times.
4. Don't get caught in moving parts. Before operating this machine remove all jewelry including watches and rings, neckties, and any loose-fitting clothing.
5. Keep your hair away from moving parts. Wear adequate safety headgear.
6. Protect your feet. Wear safety shoes with oil-resistant, anti-skid soles, and steel toes.
7. Take off gloves before you start the machine. Gloves are easily caught in moving parts.
8. Remove all tools (wrenches, check keys, etc.) from the machine before you start. Loose items can become dangerous flying projectiles.
9. Never operate a milling machine after consuming alcoholic beverages, or taking strong medication, or while using non-prescription drugs.
10. Protect your hands. Stop the machine spindle and ensure that the CNC control is in the stop mode:
 - Before changing tools
 - Before changing parts
 - Before you clear away the chips, oil or coolant. Always use a chip scraper or brush
 - Before you make an adjustment to the part, fixture, coolant nozzle or take measurements
 - Before you open safeguards (protective shields, etc.). Never reach for the part, tool, or fixture around a safeguard.
11. Protect your eyes and the machine as well. Don't use a compressed air hose to remove the chips or clean the machine (oil, coolant, etc.).
12. Stop and disconnect the machine before you change belts, pulley, gears.
13. Keep work area well lighted. Ask for additional light if needed.
14. Do not lean on the machine while it is running.
15. Prevent slippage. Keep the work area dry and clean. Remove the chips, oil, coolant and obstacles of any kind around the machine.

16. Avoid getting pinched in places where the table, saddle or spindle head create "pinch points" while in motion.
17. Securely clamp and properly locate the workpiece in the vise, on the table, or in the fixture. Use stop blocks to prevent objects from flying loose. Use proper holding clamping attachments and position them clear of the tool path.
18. Use correct cutting parameters (speed, feed, depth, and width of cut) in order to prevent tool breakage.
19. Use proper cutting tools for the job. Pay attention to the rotation of the spindle: Left hand tool for counterclockwise rotation of spindle, and right hand tool for clockwise rotation of spindle.
20. Prevent damage to the workpiece or the cutting tool. Never start the machine (including the rotation of the spindle) if the tool is in contact with the part.
21. Check the direction (+ or -) of movement of the table when using the jog or power feed.
22. Don't use dull or damaged cutting tools. They break easily and become airborne. Inspect the sharpness of the edges, and the integrity of cutting tools and their holders. Use proper length for the tool.
23. Large overhang on cutting tools when not required result in accidents and damaged parts.
24. Prevent fires. When machining certain materials (magnesium, etc.) the chips and dust are highly flammable. Obtain special instruction from your supervisor before machining these materials.
25. Prevent fires. Keep flammable materials and fluids away from the machine and hot, flying chips.
26. When working in manual mode (not CNC) make sure the computer control is switched to DRO or OFF.
27. An optional interlocked guard is available from Southwestern Industries, Inc. for TRAK Mills if the use of the table guard is deemed necessary by the user for his application.

3.0 Description

3.1 ProtoTRAK KMX CNC Specifications

The list below summarizes the features and specifications. Each feature is described in more detail in the appropriate section of the manual.

3.1.1 Basic System Specifications

Control Hardware

- Digital Servo Amplifiers – custom designed for ProtoTRAK operation
- D.C. Servo Motors – rated at 280 in-oz. continuous torque are twice that required
- Precision Ball Screws – in the table and saddle
- Modular Design – simplifies service and maximized uptime
- 115V/60HZ/10 amps
- Feedrate Override of programmed feedrate and rapid
- Polycarbonate Sealed Membrane Keypad to lock out contamination
- 9.0" Color LCD
- USB port for interface with a storage device
- Rugged Industrial PC
- Glass Scale on quill for Z-axis readout

Software

- Diameter Cutter Compensation – allows programming of the part rather than the center of the tool path
- Circular interpolation – makes arcs and any size hole easy to do with standard tools
- Linear Interpolation – to machine lines at any angle
- Conrad – provides automatic corner radius programming with one data input
- Incremental and Absolute – programming can even be mixed within an event
- Error Messages – to identify programming mistakes
- Fault Messages – for system self-diagnostics
- Parts Graphics display

- Look – a single button press to view graphics during programming
- Math Help – for finding points in a prompted format with graphical representation of prompts
- Machine Tool Error Compensation and Backlash Compensation custom set on mill after installation
- Selectable Inch/mm measurement readout
- Jog of X and Y from 1 to 100 inches per minute
- Selectable 2 or 3-axis operation
- AGE Auto Geometry Engine

Programmed Canned Cycles

- Posn/Drill – single point
- Bolt Hole – series of points evenly spaced around a circle
- Mill – straight line in any direction
- Arc – any portion of a circle
- Pocket – a rectangle, circle or irregular and all the material inside, includes finish cut
- Profile – a perimeter of a rectangle, circle or irregular shape, includes finish cut
- Repeat, Rotation, Mirror – of programmed events with or without offset

Options

- Remote Stop/Go (RSG) switch
- USB thumb drive for program storage and transfer. (See pg. 12, under The USB Ports)
- Offline programming system
- DXF and Parasolid programming on Offline

3.2 Display Pendant

3.2.1 Front

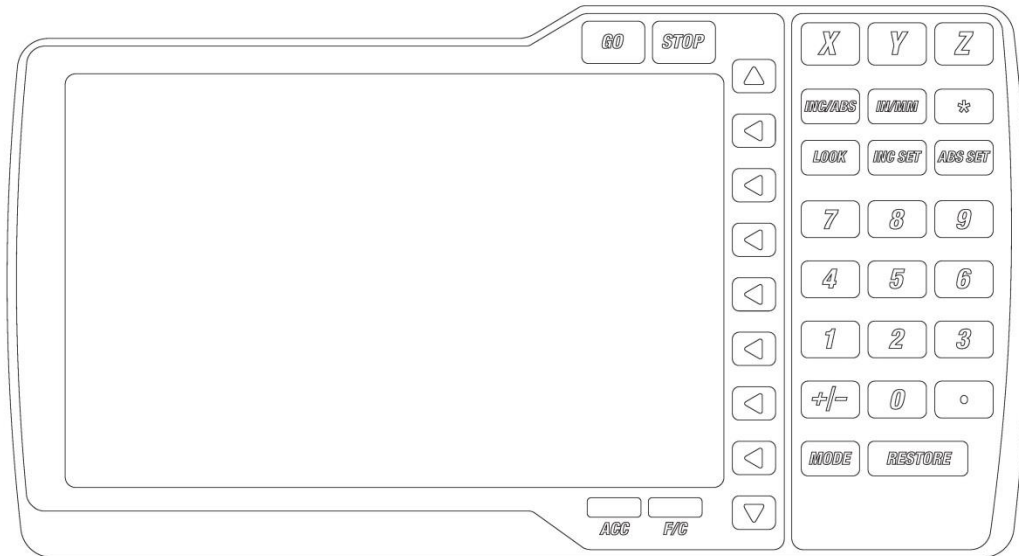

Keyboard Hard Keys

GO: initiates motion in Run

STOP: halts motion during Run

LOOK: part graphics in Program and Program I/O modes

INC/ABS: switches all or one axis between incremental and absolute

INC SET: loads incremental dimensions and general data

ABS SET: loads absolute dimensions and general data

X, Y, Z: selects axis for subsequent commands

0-9, +/-, . : inputs numeric data with floating point format. Data is automatically + unless +/- key is pressed. All input data is automatically rounded to the system's resolution.

***:** Use to toggle between default

MODE: to change from one mode of operation to another

RESTORE: clears an entry

IN/MM: causes inch to metric or metric to inch conversion of displayed data

ACC: turns accessory (coolant, spray, etc.) on and off

F/C: selects between fine and coarse resolution on Electronic Handwheels

Arrow Keys

Between the LCD Screen and the hard keys is a column of arrow keys.

Up key, down key: these are located at the top and bottom of the column, respectively. They have several uses:

- feedrate override in Run and DRO modes
- page forward, page back to move through events in a program
- data forward, data back to move through the data in an event

Right seven keys: These keys are called software programmable or soft keys. A description of the function or use of each of these keys will be shown on the LCD screen next to each key. If, at any time, there is no description beside a key, that key will not operate.

Emergency Stop Switch

The emergency stop (E-stop) switch kills all power to the ProtoTRAK's servomotors and the spindle motor when pressed on a TRAK machine. The computer and pendant remain powered.

The Liquid Crystal Display (LCD)

The display of the ProtoTRAK KMX is a 9" active-matrix color LCD.

The information displayed on the LCD screen is nearly always divided into 4 sections or areas.

The top line, or status line, shows the system's current status. This includes the mode, inch or mm measurement and part numbers.

Beneath the status line, and filling most of the screen, is the information area. Position data, program data and graphics are shown here. In addition message windows will be here in the information area.

Beneath the information area is a single "conversation" line. When numeric data is required the conversation line will appear for you to see the numbers you enter before they are set into the system.

On the right side of the LCD are boxes describing the current function or use of each soft keys located next to them.

3.2.2 Pendant Back Panel

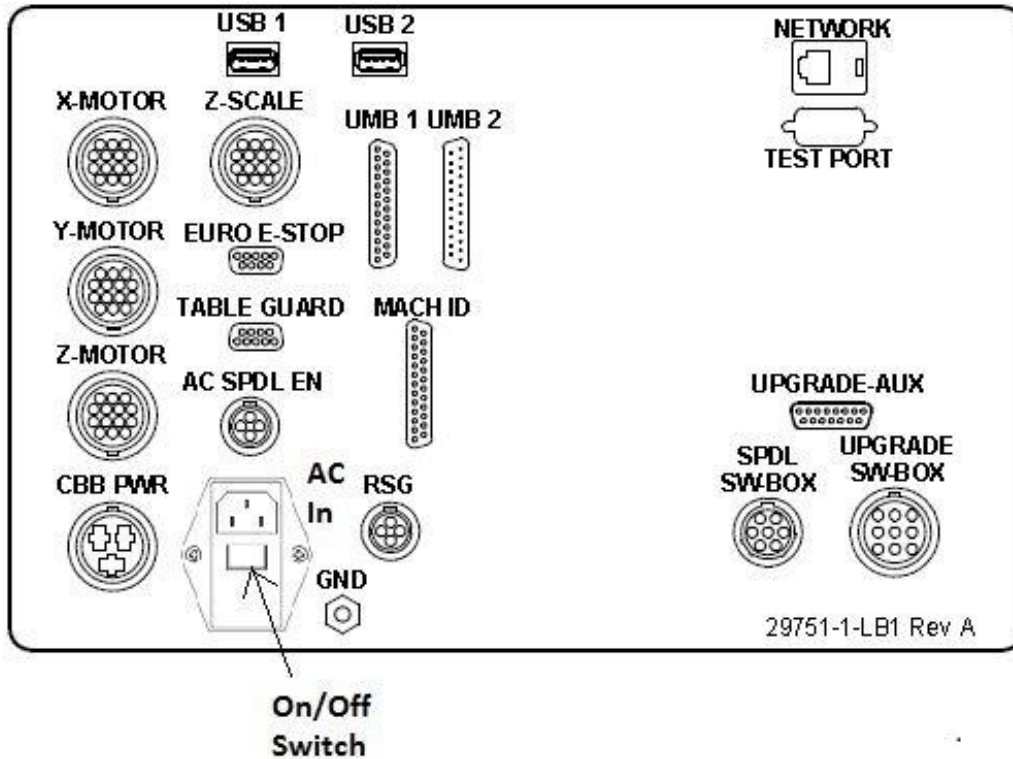

Motor

The X, Y and/or Z motor cables are plugged in as shown.

Warning:

Never plug or unplug motor cables with the power on. This will destroy the computer!

Z Scale

Plug in the Z scale cable.

Table Guard

For plugging in the interlock switch that is part of the optional table guard. Not available with retrofits.

The USB Ports

There are two USB ports, use only one at a time for an optional thumb drive for program storage, transferring programs between ProtoTRAKs and computers and for program backup. Software updates will be through the USB port.

The ports are USB2.0 compliant.

Not all thumb drives are assured to work with the KMX. The one we supply will definitely work and can be ordered as part number USB MEM.

Test port

Used by the factory for testing only.

Grd (Ground)

We recommend that you ground the ProtoTRAK display to an earth ground such as a cold water pipe.

A/C Inlet

To plug in the incoming 110v power. The on/off switch is located directly below this inlet.

CBB Pwr

110 volts out to power the cable breakout box if included. Provides power for 110 volt outlet for AUX functions

AC Spdl EN

Logic cable to enable and/or turn off the spindle to certain SWI machines only

RSG

Remote Stop and Go switch

Mach ID

Machine ID key to customize parameters to each machine type

UMB1 and UMB2

Logic connections to the Cable Breakout Box

Network

Network connection to your server, computer or other ProtoTRAKs

Upgrade Aux

Interface to DPM Bed Mill upgrade auxiliary hardware

SPDL and Upgrade SW-Box

Interfaces to upgraded DPM bed mills with separate Switch Boxes

3.2.3 Servo Motors/Amplifiers

The ProtoTRAK KMX servomotor and amplifier have been combined into a single integrated package on each axis. The motors are rated 280 in-oz. maximum continuous torque that is sufficient for the heaviest cuts.

3.2.4 Ballscrews

Precision ballscrews are installed in the table and saddle to ensure smooth traverse and positive control for manual and CNC machining.

3.3 TRAK Knee Mill Specifications

This section describes the TRAK Knee Mill machine, it does not apply to ProtoTRAK KMX retrofits.

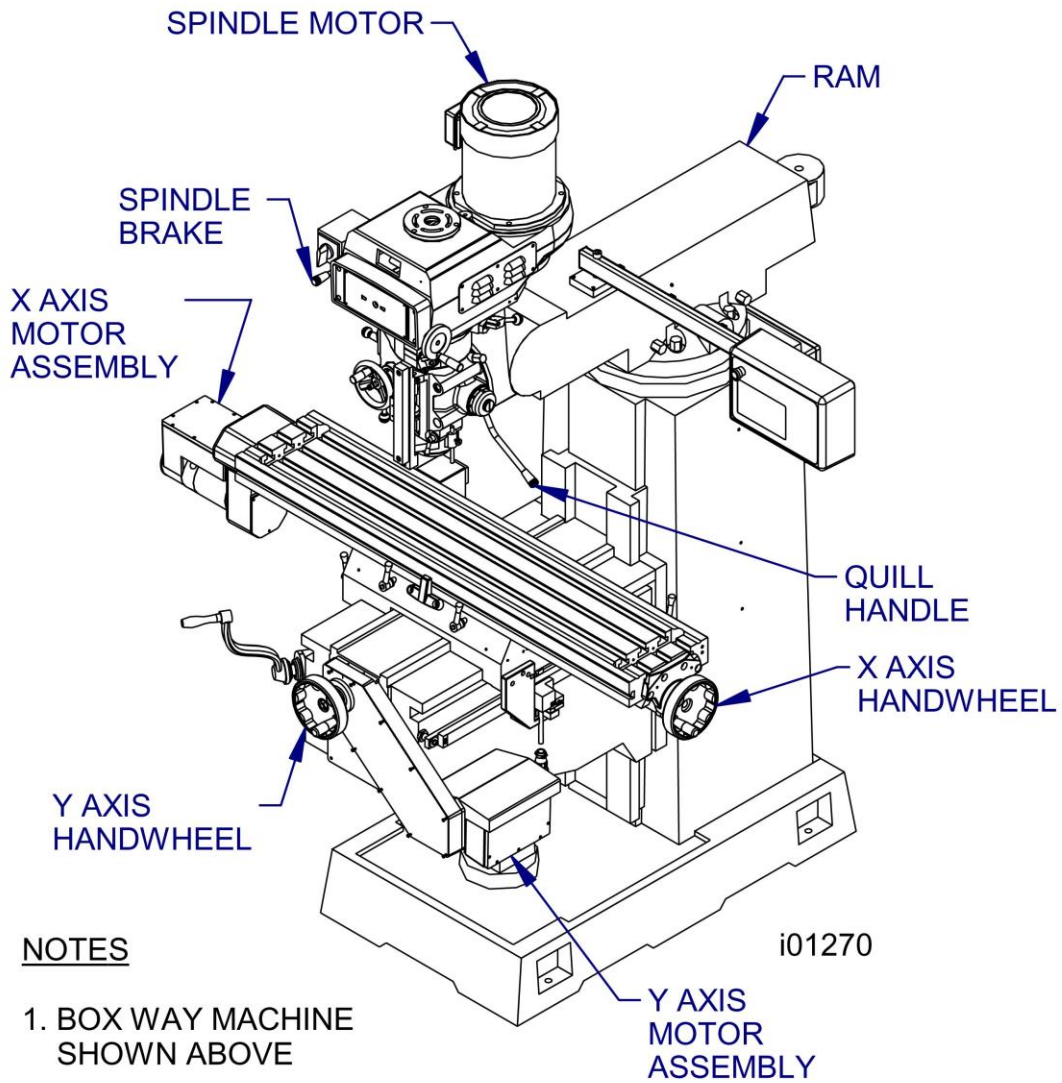

FIGURE 3.3.1 The TRAK Knee Mill Machine Overview

Item	Part Number	Description
1	20819	Spindle Motor
2	29751-1	KMX Pendant
3	15616	Y-Axis Handwheel (Saddle)
4	15616	X-Axis Handwheel (Table)
5	20296	X or Y Motor

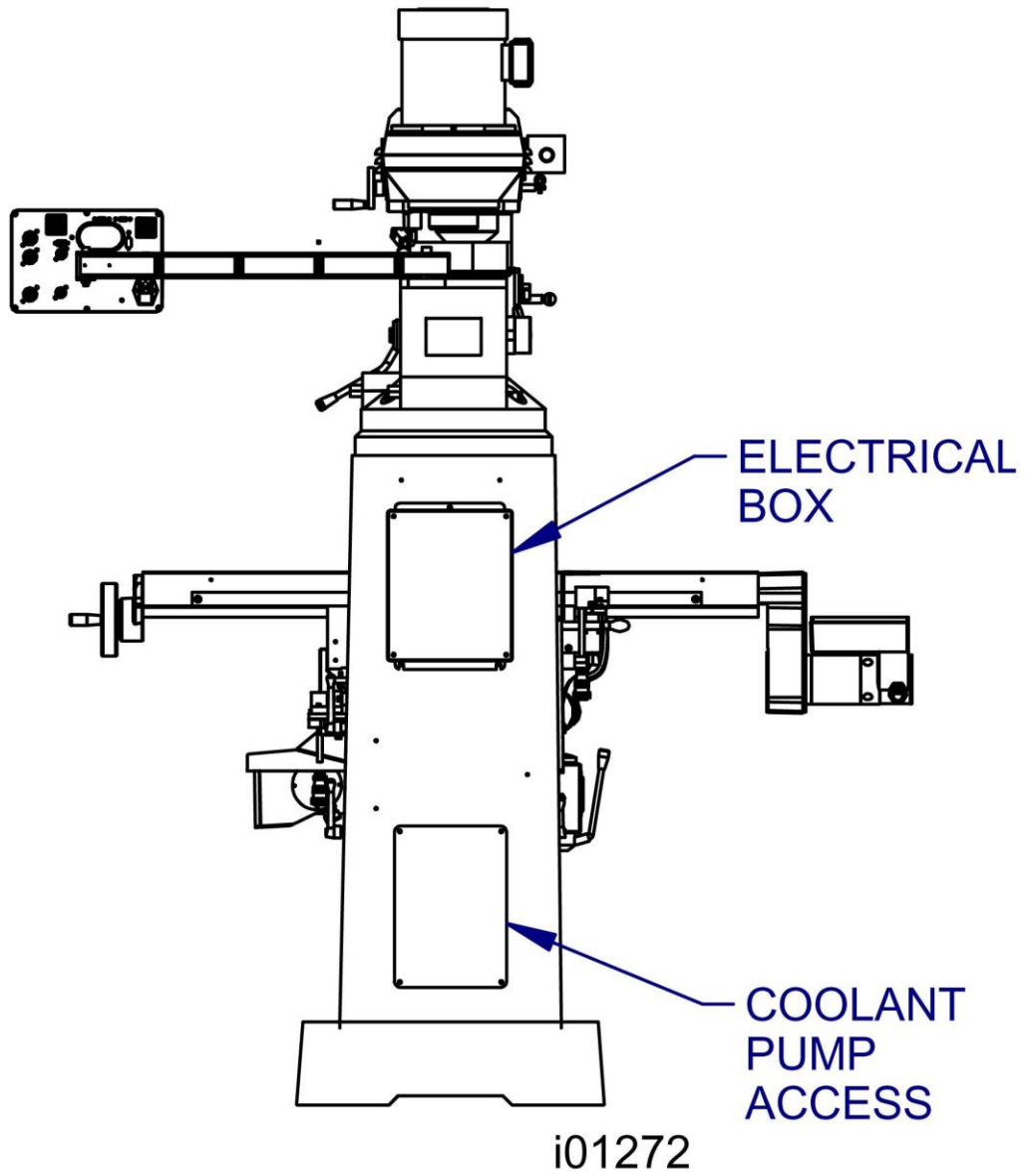

FIGURE 3.3.2 The TRAK Knee Mill back view

	TRAK K3KMX
Table Size	50" X 10"
Table Travel	32"
Saddle Travel	16"
Knee Travel	16"
Ram Travel	15"
Maximum Quill Travel	5"
Quill Diameter	3.375"
Spindle Taper	R8
Spindle Speed Vari-speed head	60-500, 600-4200 RPM
Head Tilt	45° forward and back, 90° left and right
Quill Feeds per Rev	0.0015", 0.003", 0.006"
Spindle Motor Power-Vari-speed	3HP
Power Requirement Control	110V, 1P, 10A
Power requirements, machine	208/480V, 3P, 8.5/4.25A
Maximum Weight on Table	750 lbs.
Machine Weight	2816 lbs.
Machine dims: L, W, H	71" x 59" x 84"
Max rapid feed X, Y	100 IPM
Way surface type	Dovetail X, Z, Square Y

- Precision 7207 CP4 spindle bearings
- Chrome hardened and ground quill
- Meehanite castings
- Slide ways are Turcite coated
- Wide way surfaces are hardened and ground

3.3.1 Manual Lubrication System – K3KMX Ways and Ballscrew Lubrication

The TRAK Knee Mill X, Y, Z way surfaces and ball screws are lubricated manually with the lubrication pump located on the left side of the knee. Pull the handle fully and release 4 to 6 times at the beginning of each shift, and once every four hours of operation thereafter.

1. At the beginning of each day, check the oil level in the pump. If low, fill with SAE 30 or 30W oil.
2. Every six months of operation, apply a liberal coating of Mobile Grease-MP, or equivalent to the Z-Axis knee ACME screw.

CAUTION!

Failure to manually activate the pump at the beginning of each day may cause severe damage to the TRAK Knee Mill way surfaces and ball screws.

Head Lubrication – K3KMX

Once Each Week:

1. Fill the oil cup on the lower left area of the head with SAE 30 or 30W oil.
2. Extend the quill fully and apply a coating of SAE 30 or 30W oil to the outside diameter of the quill.

Twice a Month:

1. Apply 2 drops of oil in upper cup on front of head with SAE 30 oil. This supplies oil to the feed cradle for the power quill feed to keep the grease pliable. If oil is not added, the power quill feed will be difficult to engage.

WARNING

Do not overfill this oil cup as excess oil could wash down into the upper spindle bearings and wash away the grease.

Every Four Months:

1. Apply a good grade of general purpose grease through the grease fitting on the back underside of the head to lubricate the low range gear set.

3.3.2 Auto Lube System – K3KMX Option

The auto lube system provides centralized automatic lubrication for the ways and ballscrews. The lube pumps 2-liter reservoir is serviced with Mobil Vactra Oil No. 2 or equivalent. The pump is factory set to pump oil for 15 seconds for every 60 minutes of spindle time. There is an internal memory on the pump so that the pump will not reset every time the spindle is turned off.

The pumping output can be regulated electronically to control the pause time between pumping cycles, and the duration of the pumping cycle. The following describes the buttons used to program the lube pump. In order to modify any of the settings the spindle must be on.

The pump has an alarm that will sound if any of the following problems arise:

- Oil line breakage
- Oil filter blockage
- Bad motor
- Low oil pressure
- No oil in tank

INT (Interval) - this button programs the interval between pumping cycles. Each press of the button increases the interval by one minute.

DIS (Discharge) - this button programs the amount of time the pump will discharge each pumping cycle. Each press of the button increases the discharge time by one second.

FEED - this button is used to manually feed the ways and ballscrews.

RST - this button tells the pump to discharge for the time programmed.

Factory Default Values

Interval Time - 60 min.

Discharge Time - 15 sec

Discharge Pressure - Approximately 100 - 150psi

To adjust the amount of Discharge Pressure displayed on the lube pump gauge, loosen the jam nut and turn the adjustment screw located on the top right side of the lube pump while the lube pump is activated.

At the beginning of each day, check the oil level in the Auto Lube system. If low, fill with Mobil Vactra Oil No. 2 or equivalent (SAE 30 or ISO 68).

CAUTION!

Failure to manually activate the pump at the beginning of each day, or allowing the Auto Lube to run dry may cause severe damage to the TRAK K3KMX way surfaces and ballscrews.

3.3.3 Electrical Cabinet (TRAK Knee Mills Only)

TRAK Knee Mills use two electrical inputs. Spindle 208 or 480V power is wired into the cabinet. A cord is supplied from the cabinet to a 110V power source for running the ProtoTRAK KMX CNC.

3.4 Optional Equipment

3.4.1 Power Draw Bar

A manual draw bar comes standard with the machine. A power draw bar option may be ordered. The TRAK K3KMX uses an R-8 spindle and draw bar.

3.4.2 Remote Stop Go Switch

For the convenience of operation while running the program, a Remote Stop/Go switch may be purchased. This switch is on a ten-foot cable and operates like the FEED Stop and Go keys on the display.

3.4.3 Work Light (TRAK Knee Mills Only)

An optional halogen work light is available. It mounts to the left side (facing) of the column and plugs into a 110v outlet in the electrical cabinet.

3.4.4 Coolant Pump (TRAK Knee Mills Only)

The optional coolant pump is mounted in the back of the machine column. It is plugged into the electrical cabinet and may be configured to operate as commanded by the auxiliary functions, or with a separate switch.

3.4.5 Spray Coolant (TRAK Knee Mills Only)

The Fog Buster® spray coolant option consists of a one-gallon holding tank, nozzle, air lines and an air regulator for attaching compressed air. Coolant flow is adjusted by a needle valve at the sprayer head. Air flow is adjusted at the air pressure regulator with gage. Once flows are set, sprayer operation is controlled by an air toggle switch or by interface with the optional Auxiliary Functions.

3.4.6 Chip Pan (TRAK Knee Mills Only)

The Chip Pan option is available for TRAK Knee Mills only, not available for retrofits.

3.4.7 Table Guard (TRAK Knee Mills Only)

The Table guard option provides an enclosed workspace mounted on the table. The sliding door is switched to prevent operation of the CNC Run with the door open. While it will aid in the control of chips and coolant, it is not a full, waterproof enclosure. The Table Guard is available for TRAK Knee Mills only, it is not available for retrofits.

3.4.8 USB Thumb Drive

The USB Thumb Drive option is an industrial grade Delkin Devices 512MB thumb drive. It serves the following purposes:

- Save program files for backing up or additional storage
- Load program files
- Share program files between ProtoTRAKs or computers

- Save system configuration files, including backlash and calibration values
- The thumb drive comes correctly configured for ProtoTRAK KMX.

3.4.9 Electronic Handwheels

When ordered as part of the TRAKing/Electronic Handwheels Option the electronic handwheels replace the standard mechanical handwheels for table and saddle traverse. The electronic handwheels will operate when the ProtoTRAK KMX CNC is in a Mode where the machinist controls the motion of the table and saddle. This includes the DRO Mode, the Set-Up Mode and the TRAKing operation in the Run Mode. The electronic handwheels will not operate during other functions, such as when the "Select a Mode" message appears on the screen.

Handwheel resolution is determined by the F/C key on the display. Fine feed moves .200 inches per revolution, Course feed moves .800 inches per revolution.

3.4.10 Position Encoders

The ProtoTRAK KMX CNC may be configured to run either with or without independent position encoders for X and Y travel. Optional encoders are glass scales, each with 0.005 mm (.0002") underlying resolution.

3.4.11 Limit Switches

Optional limit switches are available for the saddle and table travel.

3.4.12 Cable Breakout Box

A Cable Breakout box must be ordered separately for any knee mill or knee mill retrofit whenever the mill is equipped with Limit Switches, Electronic Handwheels and /or 3-axis knee mills with AUX function.

3.4.13 Offline Programming

Optional PTKMX Offline Programming software is available for creating part programs on your PC. Powerful DXF and Parasolid programming systems can be added to this offline software.

4.0 Basic Operation

Whether as a retrofit or as part of a TRAK Mill, the ProtoTRAK KMX CNC combines the simplicity and flexibility of using a knee or bed mill with the easy, natural user interface that makes the ProtoTRAK the top brand in CNCs for small lot machining.

4.1 ProtoTRAK KMX Basic Operation.

4.1.1 Switching the ProtoTRAK KMX CNC on and off

Turn the ProtoTRAK KMX System on by moving the on-off toggle switch located directly under the power cord.

When it is first turned on the system will display a series of boot-up screens while the ProtoTRAK KMX system loads.

You should turn the ProtoTRAK off with the following procedure:

- Press Mode, Restore, Shut Down and answer Yes.
- Turn the power off at the back panel toggle switch.

4.1.2 Screen saver

If the system is not used (either by a keystroke or by counting) for 20 continuous minutes, the LCD will turn itself off. Press any key to bring the screen back to its previous display. The key you press will be ignored except to turn the screen on.

4.1.3 Switching Between two and Three-Axis Operation

All 3-axis ProtoTRAK KMX machines may be operated in a 2-axis mode. To do so, press MODE, RESTORE and the GO TO 2-AXIS soft key. Use the same procedure to switch back the 3-axis operation. You may find that for one-off flat parts, the 2-axis operation is more convenient and quicker.

4.1.4 Modes

The functions of the ProtoTRAK KMX are divided into Modes. Modes are groups of activities that belong together. Organizing the ProtoTRAK KMX this way makes it easy to use because you don't have to memorize how to do things. Simply select the Mode and then choose from the options.

The Modes of the ProtoTRAK KMX are:

- **DRO:** Contains the DRO features for working manually or setting up to run a program.
- **PROG (PROGRAM):** Where programs are written and edited, and part graphics displayed.
- **RUN:** Where programs are run to make parts.

- **SETUP:** Where the machine and control are set up to run. This also contains the softkey for the Service Codes.
- **PROG IN/OUT:** To store and retrieve part programs from the thumb drive.
- **MATH HELP:** Routines to help you quickly and easily calculate intersections, tangencies, centers and more.

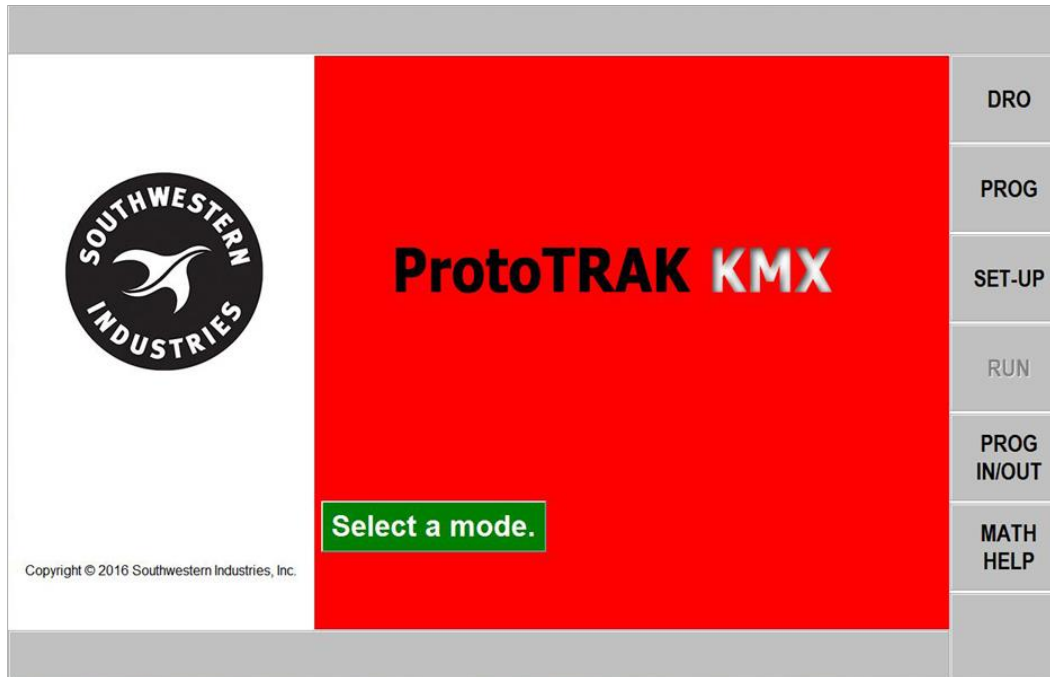

4.1.5 Emergency Stop

Press the button to shut off power to the axis motors. Power is also shut off to the spindle motor for TRAK Mills. Rotate the switch to release.

4.2 Machine Operation

This section covers the operation of the TRAK Mills. If you purchased your ProtoTRAK KMX CNC as a retrofit, please refer to the user manual that came with your machine.

4.2.1 Spindle On/Off, Forward/Reverse

The spindle switch is located on the left side of the milling head.

- Turn the Spindle switch to **left to 1** for forward (clockwise) spindle rotation if the Hi-Lo-Neutral lever is in the low position.
- Turn the Spindle switch **right to 2** for forward (clockwise) spindle rotation if the Hi-Lo-Neutral lever is in the high position.
- Turn the Spindle switch straight ahead for off.

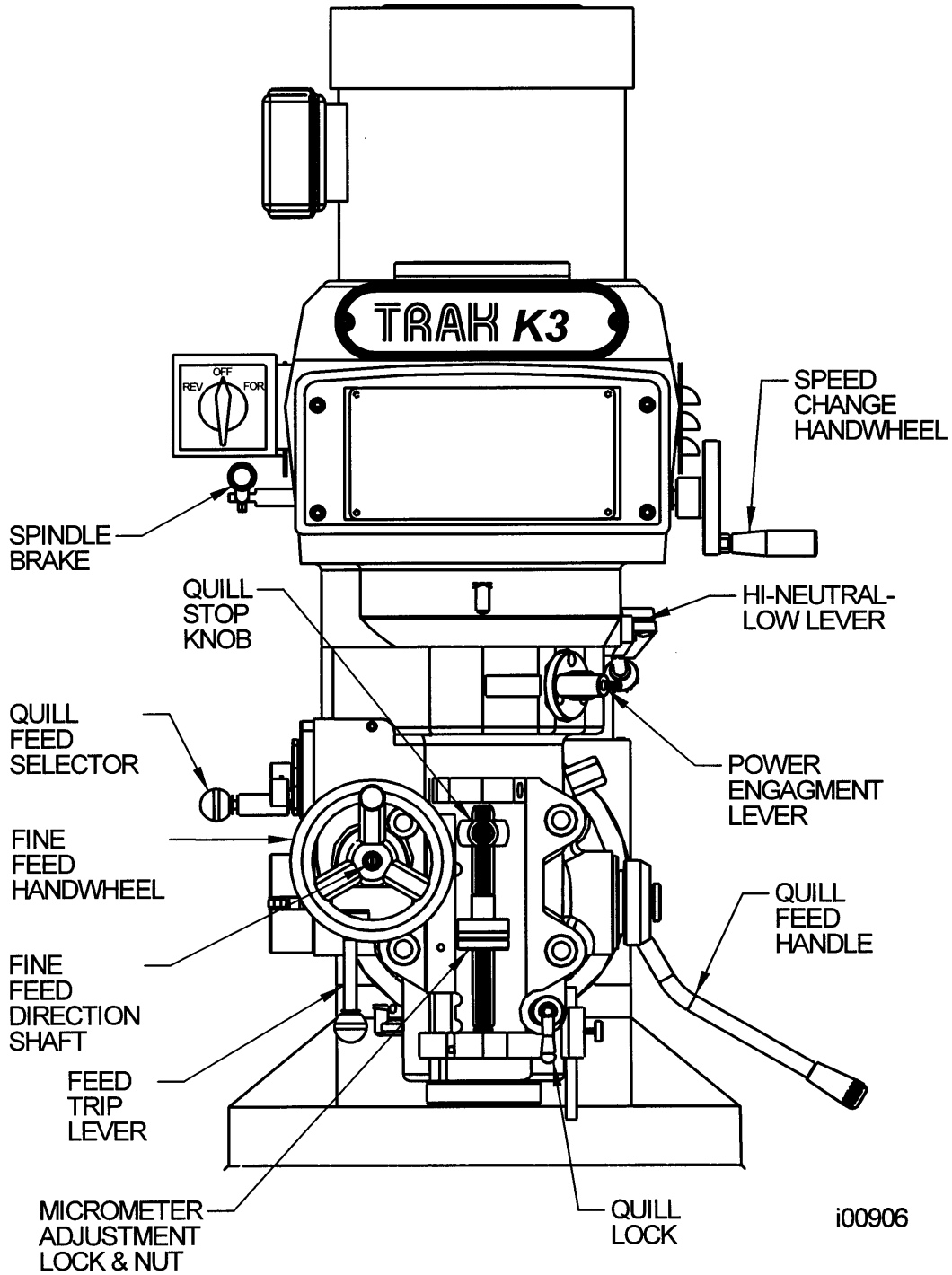

Figure 4.2.1 TRAK K3 Mill head front view. Shown without the standard quill glass scale.

4.2.2 Table, Saddle, Knee and Column Gib Locks

The table clamps are located on the front of the saddle. Rotate them clockwise until snug--overtightening is not necessary.

The saddle clamp is located on the left side of the saddle. Rotate clockwise to clamp the table until snug--overtightening is not necessary.

The knee clamps are located on the left side of the knee.

CAUTION!

Do not run ProtoTRAK KMX program unless the table and saddle clamps are free.

The table clamps are located on the front of the saddle. Rotate them clockwise until snug--overtightening is not necessary.

The saddle clamp is located on the left side of the saddle. Rotate clockwise to clamp the table until snug--overtightening is not necessary.

The knee clamps are located on the left side of the knee.

The knee is raised and lowered using the hand crank located on the left front of the knee. Clockwise rotation moves the knee up, while counterclockwise rotation moves the knee down.

Be sure the knee is unclamped before raising or lowering.

4.2.3 Spindle Brake

The mechanical spindle brake is activated pulling it down, or pushing it up. When the lever arm is in the horizontal position, the brake is off.

CAUTION!

Be certain that the spindle brake is released before starting the motor. Never attempt to activate the spindle brake when the motor is on.

4.2.4 Draw Bar

The draw bar holds the R8 tool holders into the spindle taper. The bar has a 7/16-20 right hand thread and should be tightened with a 23mm wrench from the top of the head. When tightening, it is necessary to activate the spindle brake (See 4.2.4 above). If the tool holder does not release from the spindle, lightly tap on the top of the bar to dislodge the tool.

4.2.5 High-Low-Neutral Level

The spindle RPM range selection is made through the High-Low-Neutral Lever.

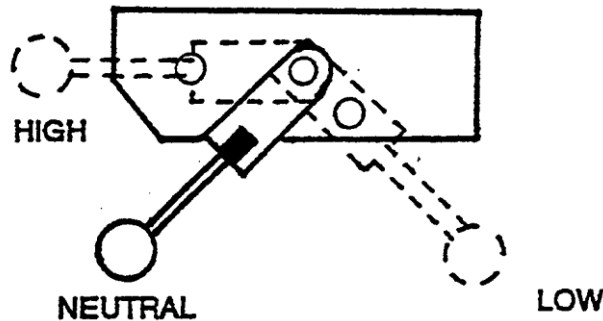

Figure 4.2.6

CAUTION!

Never attempt to change the range selection through the High-Low-Neutral lever when the spindle is rotating. Be certain the spindle ON/OFF switch is in the Off position.

Rotate the spindle by hand to help engage the lever into the high or low position.

Note: Shifting from the high to low range, or low to high range changes the direction of rotation for the On/Off switch (See Section 4.2.1).

4.2.6 Speed Changes

Spindle speed may be varied by rotating the variable speed crank.

CAUTION!

Do not rotate the variable speed crank when the spindle is stationary.

4.2.7 Operating the Quill

The quill may be moved up and down through its range with the quill feed handle. The quill may be locked into position by rotating the quill lock clockwise. Pull the handle out slightly to rotate it freely to a new position.

4.2.8 Adjusting the Quill Stop

The quill stop may be adjusted by rotating the micrometer dial nut. It is locked in place with the knurled nut.

4.2.9 Power Feed Engagement Lever

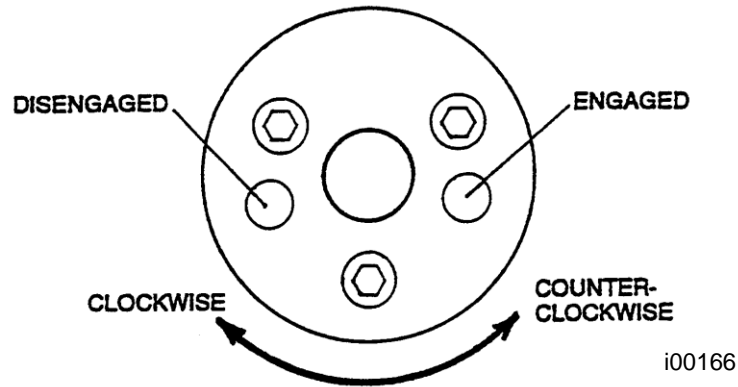

Figure 4.2.10

The power feed is engaged or disengaged with this selector. Pull out the knob and rotate it clockwise to disengage power feed. Rotate it counterclockwise to engage power feed.

CAUTION!

It is recommended that the selector be disengaged when the spindle is not running. Never have the feed engaged when the spindle RPM is over 3000. Always leave the selector in the disengaged position unless the feed function is being used.

4.2.10 Fine Feed Direction Shaft

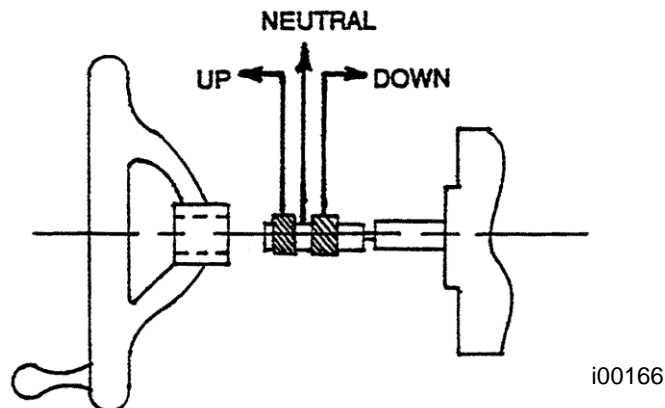

Figure 4.2.11

The direction of the fine feed is set by the position of the fine feed direction shaft. IN sets the direction down, OUT sets the direction up, and NEUTRAL in the middle.

4.2.11 Quill Feed Selector

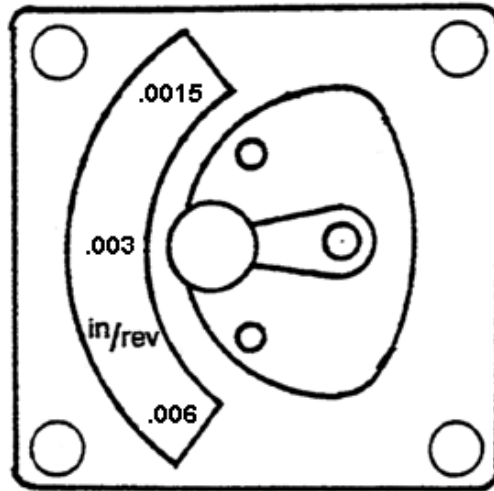

Figure 4.2.12 Quill Feed Selector for the K3KMX

This selector is used to set the quill feed speed.

To change speeds, pull the knob out and rotate the selector to the proper position. It is generally easier to change speeds with the spindle running or rotated by hand. Do not force the lever.

4.2.12 Feed Trip Lever

The Feed Trip Lever stops the quill feed motion when the quill stop knob reaches the quill micrometer dial.

Move the lever to the left to engage, or to the right to disengage.

4.2.13 Fine Hand Quill Feed

1. Disengage the Power Feed Engagement Lever.
2. Set the fine feed direction shaft to the neutral position.
3. Rotate the Fine Feed handwheel.

4.2.14 Fine Automatic Quill Feed

1. Be certain the quill lock is off.
2. Set the quill micrometer dial to the proper depth.
3. Engage the Power Feed Engagement lever when the motor is stopped.
4. Select proper quill feed (see above).

4.3 Three-Axis Changes to the Head

The head on the 3-axis TRAK K3 KMX-3 and on 3-axis retrofits is modified with a kit to drive the quill up and down. The kit is comprised of:

1. A fork bracket is substituted for the quill stop knob
2. A bracket encompassing a ball screw is attached to the fork and the front of the head
3. A servo motor is mounted on to this second bracket
4. The quill feed handle is replaced by an Electronic Handwheel

4.4 Coolant Pump / Spray Coolant

An optional coolant system may be used with any ProtoTRAK

1. If you have a 3-axis K3 KMX-3 or 3-axis retrofit this feature necessitates the purchase of a Cable Breakout Box. The coolant is controlled through the ACC (accessory) key on the KMX front panel. Press once to turn coolant on, press and hold for 2 seconds to turn on in Auto Mode where the coolant is on only when the spindle is on in Program Run. Press again to turn off.
2. If you are upgrading a 3-axis DPM bed mill, the auxiliary functions are already present from your old control and can be reused for the KMX upgrade. See (1) above for how it is used.
3. If you have any 2-axis KMX system, the coolant option will include a separate coolant on/off switch to be installed conveniently.

5.0 Definitions, Terms & Concepts

5.1 ProtoTRAK KMX Axis Conventions

X-axis: positive X-axis motion is defined as the table moving to the left when facing the mill. Consequently, measurement to the right is positive on the workpiece.

Y-axis: positive Y-axis motion is defined as the table moving toward you. Measurement toward the machine (away from you) is positive on the workpiece.

Z-axis: positive Z-axis motion is defined as moving the quill up or the head up. Measurement up is also positive on the workpiece.

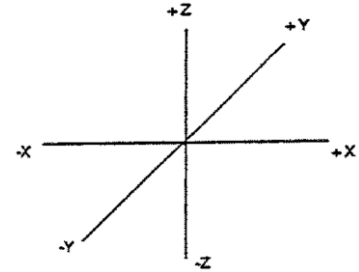

5.2 Part Geometry and Tool Path Programming

The ProtoTRAK KMX CNC gives you ultimate flexibility in programming. Programs that are entered through the ProtoTRAK KMX CNC system can be entered as either Part Geometry or Tool Path (optional).

Part Geometry programming is the popular programming style of the ProtoTRAK family of products. This is done by defining the final geometry of the part, and the ProtoTRAK KMX CNC has the job of figuring out the tool path from the part dimensions and the tool set-up information. This is a great benefit compared to regular CNC because it doesn't force the programmer to do the difficult job of defining tool path. A consequence of part geometry programming is that the following are not allowed:

- connection of an incline plane and another event
- connection of two events that lie in different planes

Using Geometry Programming, it is impossible for the ProtoTRAK KMX CNC to calculate a tool path for these cases without creating a problem: in cutting the geometry desired in the first event, the tool ends up out of position for the next event. Resolving the difference in tool position where the first event ends and the next event begins means either the CNC calculates and makes an unprogrammed move, or it retracts the tool out and then back into the part.

These cases are not encountered often, but when they are you have the option of using Tool Path programming. In Tool Path programming you define the events the same way, but all inputs are treated as tool center. It is your job to calculate and program the tool path.

Programs generated by CAD/CAM systems are always generated as Tool Path programs.

5.3 Planes and Vertical Planes

A plane is any flat surface. If that surface lies flat on the table, it is the XY plane. That is, if you move your finger along that surface or plane, you are moving in the X and/or Y direction, but not in Z (or at least not until you pick your finger up). If you tilted that surface (think of it as a piece of paper) straight up so that it faces the front of the machine, it would be in the XZ plane. If you tilted it up so that it faced left or right, it would be in the YZ plane.

A vertical plane is any plane (or surface) tipped up on its edge on the table (see below).

Unlike most CNC controls, the ProtoTRAK KMX CNC can machine arcs in any vertical plane rather than just XZ or YZ.

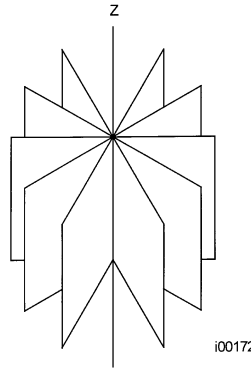
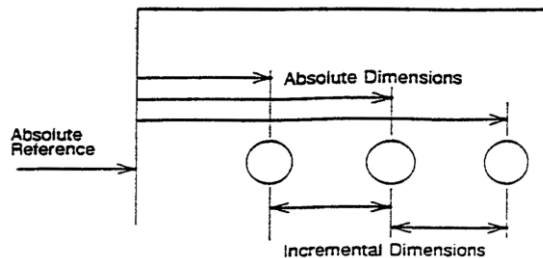

FIGURE 5.3 Vertical planes

5.4 Absolute & Incremental Reference

The ProtoTRAK KMX may be programmed and operated in either (or in a combination) of absolute or incremental dimensions. An absolute reference from which all absolute dimensions are measured (in DRO and program operation) can be set at any point on or even off the workpiece.

To help understand the difference between absolute and incremental position, consider the following example:



5.4.1 Some Rules for Incremental Reference Positions

In the section above, it was pretty clear what was meant by an incremental move. There are times that this is not completely clear. This occurs when you want to use incremental references for the first X and Y dimensioned data in a new event and the ending point of the previous event is not obvious. For example, with a circular pocket the ending point is not defined, what does the INC SET reference mean when programming the next event? Since this is not

always completely clear, there are some sensible rules for what the ProtoTRAK KMX looks at in the previous event when the first dimensioned data is entered as an INC SET.*

** For events, such as Mill, that have an X,Y beginning and an X,Y end, the second set of data is always referenced from the first.*

If the event is a:

- **DRILL**, then an incremental move is from the X, Y programmed in that previous event.
- **BOLT HOLE**, then an incremental move is from the X CENTER, Y CENTER programmed in that event.
- **MILL**, then an incremental move is from the X END, Y END programmed in that event.
- **ARC**, then an incremental move is from the X END, Y END programmed in that event.
- **CIRCLE POCKET** or **PROFILE**, then an incremental move is from the X CENTER, Y CENTER programmed in that event.
- **RECTANGLE POCKET** or **PROFILE**, then an incremental move is from the first or X1, Y1 corner programmed in that event.
- **REPEAT, ROTATE OR MIRROR**, then an incremental move is the same as for the event types shown above, but shifted by the programmed OFFSET.
- **Z rapid and Z Depth** are always incremental from the previous event. Applicable to the 3-axis KMX.

5.5 Referenced and Non-Referenced Data

Data is always loaded into the ProtoTRAK KMX by using the INC SET or ABS SET key. X, Y, Z positions are referenced data. In entering any X, Y, or Z position data, you must note whether it is an incremental or absolute dimension and enter it accordingly. All other information (non-referenced data), such as tool diameter, feedrate, etc. is not a position and may, therefore, be loaded with either the INC SET or ABS SET key. This manual uses the term SET when either INC SET or ABS SET may be used interchangeably.

5.6 Tool Diameter Compensation

Tool diameter compensation allows the machined edges shown directly on the workpiece to be programmed instead of the center of the tool. The ProtoTRAK KMX then automatically compensates for the programmed geometry so that the desired results are obtained.

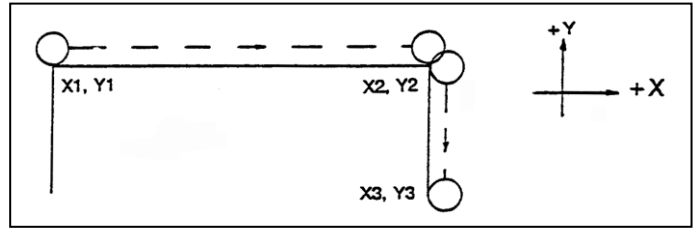

If the cutter in the sketch above is moving from left to right from point X1, Y1 to X2, Y2 and on to X3, Y3, these actual points can be programmed instead of the center of the cutter.

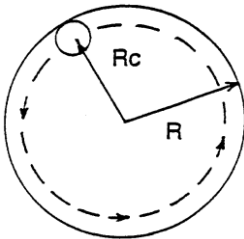

Or, the actual desired circle with radius R can be programmed instead of the radius of the center of the cutter Rc.

Tool cutter compensation is always specified as the tool either right or left of the workpiece while looking in the direction of the tool motion.

Examples of tool right are:

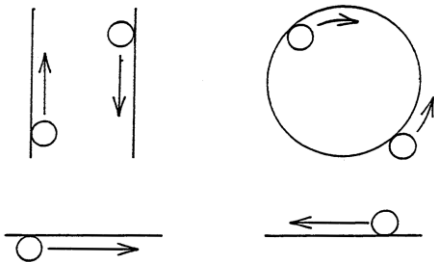

Examples of tool left are:

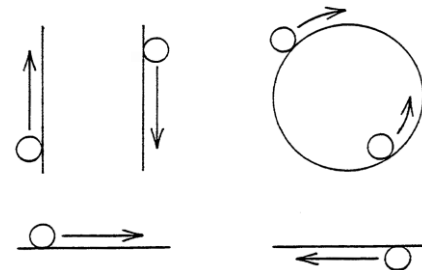

Tool center means no compensation either right or left. That is, the centerline of the tool will be moved to the programmed points.

5.7 Tool Diameter Compensation when Contouring in Z with Part Geometry

Left and right tool diameter offsets are always those projected into the XY plane. Tool offsets in the Z direction are always up and assume the use of a ball end mill. When contouring in the Z-axis, this up tool offset is always activated regardless of left, right, center if the Part Geometry option is selected. There is no Z-axis up tool offset applied when the Tool Path option is selected.

Special attention must always be paid to tool offsets when machining with a ball end mill. The reason for this is that the tool diameter changes in the bottom part (that portion equal to the tool radius) of the tool.

The tool is always positioned at the beginning of a milling operation so that the correct point on the ball end of the tool is tangent to the beginning point, and offset perpendicular to the machined edge by the radius of the tool. Consider the example below of milling a ramp in the XZ plane from point B to point C.

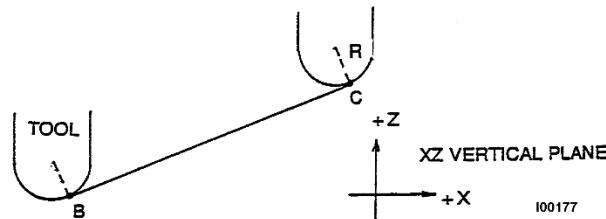

FIGURE 5.7.1 Ball end mill position with respect to program points. Tool starts so end mill is tangent to BC. R from center of tool is perpendicular to BC

Note how the tool at the beginning point (point B) starts below (in the Z direction) point B so that it can actually touch this point. If this were not true, a cusp would remain to the left of point B.

Now consider a similar example milling from A to B to C in the XZ plane.

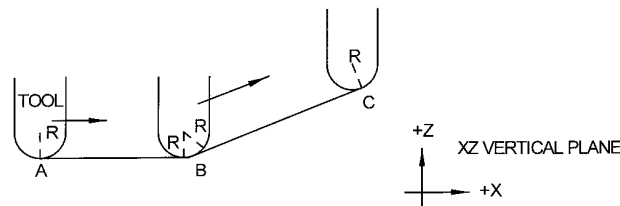

FIGURE 5.7.2 In order to respect the lines defined by the programmed points, the ball end mill never touches point B. Tool starts centered over A offset up by the tool radius R. It moves right until it is tangent to both AB and BC. Then moves to point C as in the first example

Note the Tool at B does not drop below the AB line and, therefore, never touches point B. As a result, a fillet is formed at point B equal to the tool radius.

This second example of continuous machining from one cut (AB) to another (BC) with full cutter compensation between requires the two cuts to be made with events which are connective (see Section 5.8 or 5.9 for a more complete discussion of this requirement).

5.8 Connective Events

Connective events occur between two milling events (either Mill or Arc) when the X, Y, and Z ending points of the first event are in the same location as the X, Y, and Z starting points of the next event. In addition, the tool offset and tool number of both events must be the same.

5.9 Conrad

Conrad allows you to program a tangentially connecting radius between connective events, or tangentially connecting radii for the corners of pockets and frames without the necessity of complex calculations.

For this figure, you simply program a Mill event from $X1, Y1$ to $X2, Y2$ with tool right offset, and another Mill event from $X2, Y2$ to $X3, Y3$ also with tool right offset. During the programming of the first Mill event, the system will prompt for Conrad at which time you input the numerical value of the tangentially connecting radius ($r=k$). The system will calculate the tangent points $T1$ and $T2$, and direct the tool cutter to move continuously from $X1, Y1$ through $T1, r=k, T2$ to $X3, Y3$.

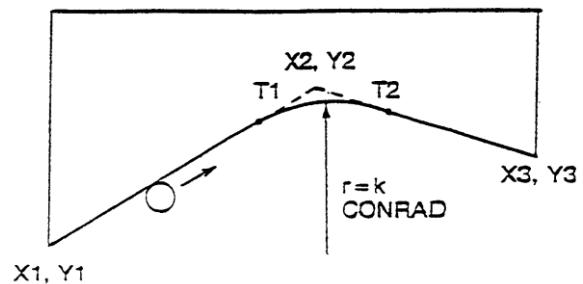

For this figure, you program an Arc event from $X1, Y1$ to $X2, Y2$ with tool offset left, and another Arc event from $X2, Y2$ to $X3, Y3$ also with tool offset left. During the programming of the first Arc event, the system will prompt for Conrad at which time you input the numerical value of the tangentially connecting radius $r=K3$. The system will calculate the tangent points $T1$ and $T2$ and direct the tool cutter to move continuously from $X1, Y1$ through $T1, r=K3, T2$ to $X3, Y3$.

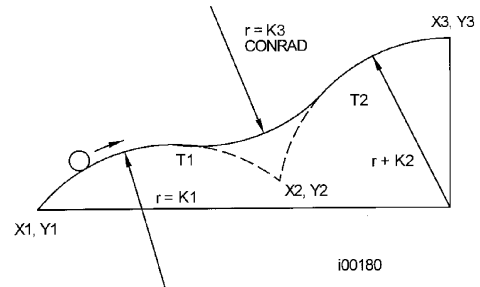

Note: Conrad must always be the same as or larger than the tool radius for inside corners. If Conrad is less than the tool radius, and an inside corner is machined, the ProtoTRAK KMX will ignore the Conrad.

5.10 Memory and Storage, Virus Protection, Microsoft Updates

Computers can hold information in two ways. Information can be in **current memory** or in **storage**. Current memory (also known as RAM) is where the ProtoTRAK KMX holds the operating system and any part program that is ready to run.

In contrast, storage is where the programs are saved until they are erased deliberately. Programs are stored on the ProtoTRAK KMX on an external thumb drive that is capable of holding hundreds of typical programs.

If power is lost or turned off, programs that are in current memory are lost, but programs stored on the thumb drive are not.

Virus Protection:

As a device, ProtoTRAK CNCs are not generally susceptible to viral infections. The part “programs” they run are non-executable text files. You can further assure protection by avoiding e-mail programs and web browser programs loaded onto the ProtoTRAK and by using a router with a firewall. An anti-virus program is not necessary since the virus risk is low, and is not recommended because the background tasks may cause damage by interfering with ProtoTRAK real-time operation.

Microsoft Updates:

Please note that the ProtoTRAK control is not designed to be automatically downloading updates from Microsoft, or for that matter any 3rd party software. There is only a limited amount of free space on the compact flash card, and downloading files to it until it is full may result in the ProtoTRAK to stop working properly.

Also note, that administrators must exclude the ProtoTRAK from programs such as Windows Server Update Service, where the software will automatically try to download updates to the control.

6.0 Using the ProtoTRAK KMX as a DRO

The ProtoTRAK KMX operates in DRO Mode as a sophisticated digital readout with jog and power feed capability.

6.1 Enter DRO Mode

Press MODE, select DRO soft key. The screen will look as follows on the 3 axis model.

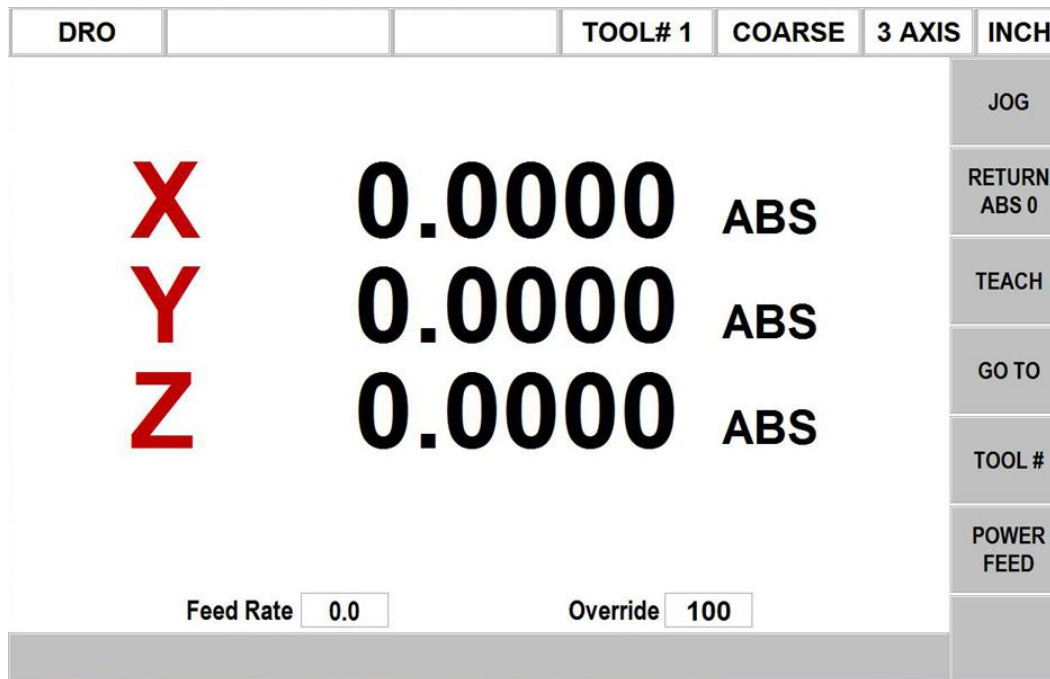

Note: the RETURN soft key is lit when in Jog.

6.2 DRO Functions

- **Clear Entry:** Press RSTR, then re-enter all keys.
- **Reset One Axis:** Press X or Y or Z, INC SET. This zeros the incremental position in the selected axis.
- **Preset:** Press X or Y or Z, numeric data, INC SET to preset selected axis.
- **Reset Absolute Reference:** Press X or Y or Z, ABS SET to set selected axis absolute to zero at the current position.

Note: This will also reset the incremental dimension if the absolute position is being displayed when it is reset.

- **Preset Absolute Reference:** Press X or Y or Z, numeric data, ABS SET to set the selected axis absolute to a preset location for the current machine position.

Note: This will also reset the incremental dimension if the absolute position is being displayed when it is preset.

- **Recall Absolute Position of All Axes:** Press INC/ABS. Note the dimension for each axis is labeled INC or ABS. Press INC/ABS again to revert to the original reading.
- **Recall Absolute Position of One Axis:** Press X or Y or Z, INC/ABS. Note the INC or ABS label for each axis. Repeat to get selected axis back to original reading.
- **Inch to MM or MM to Inch:** Press IN/MM and note LCD status line.

6.3 Jog

The servo motors can be used to jog the table.

1. Press the JOG soft key.
2. The feedrate box will read 100 indicating the table will move in the X or Y positive direction at 100 inches per minute. A message will flash to warn you that JOG is activated.
3. Press +/- to reverse direction. The feedrate box will change to - 100" Press +/- again to go back to JOG + (the + is not shown).
4. Press the down arrow key (to the right of the LCD screen) to reduce the jog speed in 10 percent increments. The feedrate and override boxes will show these adjustments. Press the up arrow key to increase the speed. The range is between 10% and 150%.
5. Press and hold X or Y to jog that axis. Release the key to stop.
6. To jog at a given rate, for example, 25 inches per minute, simply press '25' while the jog message is flashing. This number will appear in the feedrate box. When you press X or Y you will jog at this rate. Press the up or down arrow keys to adjust. In metric this number represents the percent of the maximum, or 2540 mm/min.
7. Press RETURN soft key to return to manual DRO operation.

6.4 Return to Absolute Zero

At any time during manual DRO operation you may automatically move the table to your absolute zero location in X and Y by pressing the RETURN ABS 0 softkey. When you do, the conversation line will read "Ready to begin. Press Go when ready." Make sure your tool is clear and press the GO key. When you do, the servos will turn on, move the table at rapid speed to your X and Y absolute zero position, and then turn off. You will be at zero and in manual DRO operation.

In 3-axis, Z will return to your program Z retract location and then X and Y will move to their absolute zero position.

6.5 Teach

Teach gives you the ability to enter X and Y dimensions into a program. It can be a useful way of entering a few manual moves for operations like clearing out excess material or remembering a few hole locations.

The process of using Teach is in two parts. The first part takes place in the DRO Mode. This is where you start the Teach program, establish the program events and enter the X and Y dimensions. The second part is in the Program Mode. This is where you complete the Teach events that you began in the DRO Mode by entering the rest of the data. Once the data is entered, the Teach events become just like the other events that make up a program.

6.5.1 Entering Teach Data

From the DRO screen, press Teach.

On the top of the screen, you will see the message "Teach" and an event counter. When you enter Teach, you are actually programming events. If there is already a program in current memory, Teaching will add events to the end of the program. If there is not already a program in current memory, Teaching will start a new program. For example, if you already had a program in current memory that had 10 events, when you press Teach, the event counter will say EVENT 11. If there is no program, the event counter will say EVENT 1.

The event counter shows the event for which data is being entered. You may teach in position, drill, and mill events only.

On the first Teach screen, the softkeys are:

POSN DRILL: a position / drill event.

MILL BEGIN: the beginning of a straight line or MILL event.

END TEACH: ends the teaching process and returns you to the main DRO screen.

If you press the POSN DRILL key, the event counter will go up by one and the screen remains the same. If you press the MILL BEGIN key, the event counter stays on the same number. That is because you have given the beginning point of the line but not yet the end. The softkey selections will change to:

MILL END: the last point of the Mill event. Press this to end the Mill event and select a POSN DRILL or new MILL event.

MILL CONT: the last point of the current Mill event, but the beginning of the next Mill event. You may enter successive Mill events by pressing the MILL CONT key.

Pressing either of the above softkeys will cause the event counter to increase by one.

At any time you may exit the Teach screen and return to the DRO screen. The events you have defined with their X and Y dimensions are finished in the Program Mode. See Section 7.3.7.

The Z information also needs to be filled in once you go back to program mode. This is applicable when running a 3-axis KMX mill.

6.6 GO TO (TRAKing / Electronic Handwheel Option)

The Go To function in the DRO mode allows you to set a dimension in X, Y or Z at which you want the machine to stop moving when you are cranking manually. For example, if you wanted to machine manually exactly 2" of table motion from absolute 0, you would input: Go To, X, 2, Abs Set. While the Go To window is displayed, the ProtoTRAK KMX will not let you pass that 2" dimension you set.

- a. Press the Go To key.
- b. Enter the axis, X, Y, Z or any combination. Input the dimension(s).
- c. Press Abs Set.
- d. Crank the handwheel. Motion will stop at the entered dimension even if you continue to crank the handwheel.

6.7 Tool #

The Tool # softkey is used in 3-axis mode when you want to change the tool you have in the spindle. The Z DRO prompt will update once you enter in a new tool number, assuming you have set the tool length offset in the tool table.

6.8 Power Feed

The servomotors can be used as a power feed for the table, saddle and quill (or head for DPMs), or all three simultaneously.

1. Press the POWER FEED soft key.
2. A message box will appear that shows the power feed dimensions. All power feed moves are entered as incremental moves from the current position to the next position.
3. Enter a position by pressing the axis key, the distance to go and the +/- key (if needed). Input the entry by pressing INC SET. For example, if you wanted to make a power feed move of 2.00" of the table in the negative direction, you would enter: X, 2, +/-, INC SET.
4. Initiate the power feed move by pressing GO.
5. The feedrate is automatically set to 10 ipm (or 254 mm per min). Press the up or down arrow key to the right of the LCD screen to adjust the feedrate from 1 ipm to 100 ipm. (or 254 to 2540 mmpm)
6. Press STOP to halt power feed. Press GO to resume.

7. Repeat the process beginning at "3" above as often as you wish.
8. Press RETURN soft key to return to manual DRO operation.

7.0 Programming

The ProtoTRAK KMX can be easily programmed for a wide variety of parts in two and three axes.

A program is one or a series of **events**. It can either be a complete part, a set of operations on a side or only a small number of cuts. It is necessary to create a program when you want the CNC to machine the part for you.

7.1 Enter Program Mode and Assign a Program Name

To start programming, press MODE and select PROGRAM softkey. For a new program to be written, there cannot already be a program in the active or current program memory.

When you first enter Program Mode, you will encounter a screen that allows you to enter a program name or to enter the program at different events.

Event 0 is where you can enter the program name. You can also get to Event 0 by pressing Page Back from Event 1.

The program name is highlighted and you may enter a new program name at this point. Program names consist of one to eight numbers.

Note: It is not necessary to enter a program name. If none is entered and the INC SET or ABS SET button is pushed, the system will assume the program name is 0.

The ProtoTRAK KMX automatically holds all of the completed events as you program in current memory.

Choices at the beginning of Program Mode:

GO TO BEGIN: puts Event 0 on the left side of the screen and the first event on the right side.

GO TO END: puts the last programmed event on the left side of the screen and the next event to be programmed on the right side.

GO TO #: enter the event number you wish to go to and then press SET. This puts the requested event number on the right side of the screen and the previous event number on the left.

Note: for a new program that has no Events, all the GO TO selections will take you to the beginning, with Event 0 on the left and the Select an Event options for Event 1 on the right.

7.1.1 General Programming Options

Use the Up and Down Arrow keys to select general programming options, in Event 0.

Scale: Allows a scale factor between .1 and 10. An input of 5 means the part will be 5 times as big as the programmed dimensions. A value of 1.0000 is assumed if nothing is input.

Dwell Request: Allows you to input a dwell at the bottom of a drill bolt hole or bore cycle for events you select. Select the appropriate **YES** or **NO** soft key. If you select **YES** you will be prompted to input a dwell time in seconds from .1 to 99.9 when appropriate to the event being programmed.

Auxiliary Function Request: Asks if you wish to activate any of the optional auxiliary functions (see Section 7.1.2) at any time during the program. Select the appropriate **YES** or **NO** soft key. If you select **YES** you will be prompted to input the type and sequencing of the auxiliary functions during event programming.

Dimension Definition: The ProtoTRAK KMX CNC gives you a choice in programming either tool path or geometry. Part Geometry programming allows you to define the geometry you want your part to have and then the CNC does the difficult job of calculating tool path for you automatically. This is a great benefit for most parts most of the time because it means that the CNC is doing the hard work of determining tool position.

One restriction to part geometry programming is that for events to be connective, they must lay on the same plane (see Section 5.3 for a definition of planes). For this reason, the ProtoTRAK KMX CNC gives you the option of entering your own tool path. If you wish to program the part by defining tool path yourself, you may choose the TOOL PATH softkey. Otherwise, Part Geometry programming is assumed. Tool Path operates under the same rules as standard RS274.

A program must be entirely written in Part Geometry or Tool Path programming, you cannot combine the two methods in one program.

Input Z End For Verify: Verify is a 3-D solid graphical representation and 3-D, of course, needs Z data as well as X and Y. However, on 2-axis ProtoTRAK KMX programs only X and Y dimensions are programmed. Activating the Input Z End For Verify feature adds a Z END prompt to each event when programming in 2-axis. This input is used only to enable the Verify features.

To activate, go to the Event 0 screen, data forward to the Input Z End For Verify option with the Up and Down Arrow keys and press the YES soft key. The Z END value only needs to be entered on the first event if multiple events are at the same depth. For example, if your program has 10 events with events 1-5 machined at a depth of 1/2 inch and events 6-10 at 3/4 inch, you only need to enter a Z END value in events 1 and 6.

7.1.2 Auxiliary (AUX) Functions

Auxiliary Functions are not available on 2-axis knee mill applications or on 3-axis knee mill upgrades. Auxiliary Functions are optional on new 3-axis knee mill applications and standard on 3-axis bed mill upgrades.

When the Auxiliary Function option is installed and active, the ProtoTRAK KMX CNC can control four different auxiliary functions. You can select whether to activate or deactivate these functions at the beginning or end of each event.

If Auxiliary Functions are selected on the program header, the system will prompt for AUX BEG and AUX END in each event.

When running programs with Auxiliary functions, the ACCESSORY hard key on the front panel must have the correct status. If you want the program to automatically turn the Auxiliary functions on and off, press and hold the ACCESSORY key until the status line reads ACC AUTO. Press again to turn off.

AUX BEG Options:

Input:	Function	Comments
0	None	No Auxiliary functions will begin when this event begins to run.
1	Coolant/Air	The coolant pump or air solenoid will be turned on when this event begins to run.
3	Indexer	Activates an electronic signal at the beginning of the event. See note below.

AUX END Options:

0	None	No Auxiliary functions will turn off at the end of this event.
1	Coolant/Air Off	Turns the coolant or air solenoid off at the end of this event.
3	Indexer	Activates an electronic signal at the end of this event. See note below.
4	Spindle	Turns off the spindle at the end of this event. Note, the spindle automatically turns off for each tool change – it is not necessary to program a spindle off.

Coolant/Air on and off is automatically programmed for tool changes. If you want the air or coolant pump on while cutting the entire part, you need only program the Aux begin in the first event and Aux end in the last event. The coolant pump or air solenoid will turn on at the beginning of the programmed event and will turn off during tool changes.

The Indexer function is designed to operate with a standard indexer. Programming an Aux 3 at the beginning or end of an event will cause the ProtoTRAK KMX CNC to stop machining at the beginning or end of the event and wait for a signal from the indexer. The signal notifies the CNC that the indexer has finished its programmed move. The CNC will then automatically resume the program. Make sure your tool is clear of the workpiece before commanding an index. If need be, add an Aux 3 to the end of a position event.

7.2 Programming Strategy and Procedures

The ProtoTRAK KMX makes programming easy by allowing you to program the actual part geometry as defined by the print. The basic strategy is to select the softkey event type (geometry) and then follow all instructions in the conversation line. When an event is selected, all the prompts will be shown on the right side of the information area. The first prompt will be highlighted and also shown in the conversation line. Input the dimension or data requested and press INC SET or ABS SET. For X or Y or Z dimension data it is very important to properly select INC SET or ABS SET. For all other data either SET will do.

As data is being entered it will show in the conversation line. If you make a mistake, for example, you press the wrong number key, you can clear the input by pressing RESTORE. When SET, the data will be transferred to the information area, and the next prompt will be shown in the conversation line.

From the event data screen you may press the up arrow key to the upper right of the LCD screen to go back to edit any data within an event.

Options within an event include:

PAGE FWD: moves forward through the programmed events.

PAGE BACK: moves backwards through the programmed events.

INSERT EVENT: use this to insert a new event into the program. This new event will take the place of the one that was on the right side of the screen when you pressed the INSERT EVENT key. That previous event, and all the events that follow, increase their event number by one. For example, if you started with a program of four events, if you were to press the INSERT EVENT key while Event 3 was on the right side of the screen, the previous Event 3 would become Event 4 and the previous Event 4 would become Event 5. If you insert a Repeat event, the event numbers will increase by one as when you insert another kind of event.

DELETE EVENT: this will delete the event on the right side of the screen.

When all data for an event has been entered, the entire event will be shifted to the left side of the screen and the conversation line will ask you to select the next event.

PROG			COARSE	3 AXIS	INCH
EVENT 0		EVENT 1			POSN DRILL
PROGRAM NAME					MILL
SCALE	1.000				ARC
DWELL REQUEST	NO				POCKET
AUX FUNCTION	NO				PROFILE
DIM DEFINITION	PART GEO				SUB
Select an event.					PAGE BACK

7.3 Programming Events – (2 axis mode)

The following events are found in the ProtoTRAK KMX when running in 2 axis mode only. See section 7.4 for 3- axis events.

7.3.1 Posn Drill

This will position the table and saddle to the location you define. This event is used for drilling holes and other positioning moves.

When you press the POSN/DRILL key, you choose between:

- **One:** a single position.
- **Bolt Hole:** a series of positions spaced evenly around a circle.

When the program is run at a Posn/Drill Event, the ProtoTRAK KMX will servo at rapid (or as modified by you) to each location defined and will wait for you to finish the operation (e.g., drill the hole) and press the GO key before moving on.

7.3.2 Mill Event

Use this to machine a straight line in any direction. The prompts you answer in this event will allow the ProtoTRAK KMX to calculate the complete tool path, including the starting position and tool offsets. It is not necessary to program a rapid move to the beginning position of the Mill Event.

When the program is run at a Mill Event, the ProtoTRAK KMX will rapid to the beginning position, prompt you to set the quill Z depth, move through the Mill Event at the speed you program and end at the ending position.

7.3.3 Arc Event

This is any part of a circle. Like the Mill Event, the prompts you answer will allow the ProtoTRAK KMX to calculate the complete tool path.

When the program is run at an Arc Event, the ProtoTRAK KMX will rapid to the beginning position, prompt you to set the quill Z depth, move through the Arc Event at the speed you program and end at the ending position.

7.3.4 Pocket Event

Use this event to machine a pocket with a minimal amount of programming. When you press the Pocket key, you choose between the following:

Circular Pocket: a circle and all the material in the center. Includes finish cut.

Rectangular Pocket: a rectangle and all of the material in the middle. Includes finish cut.

Irregular Pocket: an irregular shaped pocket and all of the material in the middle (see Section 8 for programming irregular shapes using AGE).

Face Mill: for machining the entire top of a part. No finish cut.

When the program is run as a Circular or Rectangular pocket event, the ProtoTRAK KMX will rapid from wherever it is to the center of the pocket and prompt SET Z. After you have set the cutter and pressed GO it will machine outward to the final shape (minus the finish pass) and then then make the finish pass.

When the program is run as an Irregular pocket event, the ProtoTRAK KMX will rapid to the southern-most (or lowest Y dimension) leg, prompt SET Z, then machine in a zig-zag path and contour around on the finish path.

When the program is run as a Face Mill event, the ProtoTRAK KMX will rapid to just off the part as defined by X1,Y1, prompt SET Z and mill in a zig-zag pattern to finish just off the part as defined by X3,Y3.

7.3.5 Profile Event

Use this event to machine a profile with a minimal amount of programming. When you press the Profile key, you choose between the following:

- **Circular profile:** a circular circumference. Includes finish cut.
- **Rectangular profile:** a square or rectangular circumference. Includes finish cut.
- **Irregular profile:** an irregular path that can be open (it doesn't finish where it starts) or closed (it does finish where it started). Includes finish cut. See Section 8 for programming irregular shapes using AGE.

When the program is run as a Circular profile the ProtoTRAK KMX will rapid to the 3 o'clock position and prompt to SET Z. After you have set the cutter and pressed GO it will machine around the profile offset by the finish cut and then make the finish pass.

When the program is run as a Rectangular profile the ProtoTRAK KMX will rapid to the X1, Y1 corner, prompt SET Z, machine around the profile offset by the finish cut and then make the finish pass.

When the profile is run as an Irregular profile the ProtoTRAK KMX will rapid to the beginning of the first programmed Mill or Arc offset by the finish cut, prompt SET Z, machine to the end of the last Mill or Arc event and then make the finish pass.

7.3.6 Subroutine Events

The Subroutine Events are used for manipulating previously programmed geometry within the XY plane.

The Subroutine Event is divided into six options: Repeat, Rotate and Mirror as a subroutine, or Repeat, Rotate and Mirror as a copy.

Copy Events are programmed exactly like Subroutine Events. The only difference is that in Copy the events are rewritten into subsequent events. If, for example, in event 11 you Copy Repeated events 6, 7, 8, 9, 10 with 1 repeats, events 6-10 would be copied with the input offsets into events 11-15.

Copy Events may be Repeat, Mirror or Rotate.

Copy is very useful. With Copy you can:

- Edit the events that are being repeated, mirrored or rotated without changing the original events.
- Connect so that the quill will not move up to the Z Rapid position, and back down unnecessarily. However, to be connective, you must be certain that the X, Y, Z begin of the first event, once offset or rotated, coincides with the X, Y, Z end of the last event.
- Program an event parallel to X or Y (where the geometry is the easiest to describe), rotate it to the desired position, then delete the original.

Repeat, Rotate and Mirror may be connective. As long as the rules of connectivity are satisfied, the ProtoTRAK KMX will continue milling between preceding and subsequent events.

REPEAT allows you to repeat an event or a group of events up to 99 times with an offset in X and/or Y and/or Z. This can be useful for drilling a series of evenly spaced holes, duplicating some machined shapes, or even repeating an entire program with an offset for a second fixture.

Repeat events may be "nested." That is, you can repeat a repeat event, of a repeat event, of some programmed event(s). One new tool number may be assigned for each Repeat Event. Repeat events may be "nested" up to five deep.

ROTATE is used for polar rotation of parts that have a rotational symmetry around some point in the XY plane. In addition to specifying the events to be repeated, you must also indicate the absolute X and Y position of the center of rotation, the angle of rotation (measured counterclockwise as positive; and

clockwise as negative), and the number of times the specified events are to be rotated and repeated. You may not rotate another rotate event. Consider the figure below:

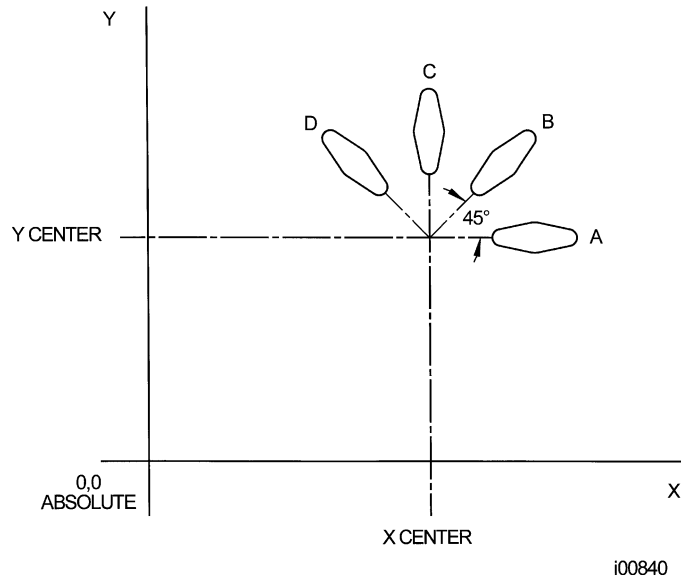

FIGURE 7.3.6.1 *Shape A programmed with 4 MILL events and Conrads. Using ROTATE, these 4 events are rotated through a 45 degree angle about a point offset from absolute zero by X Center and Y Center dimensions. A is rotated 3 times to produce shape B, C, and D.*

MIRROR is used for parts that have symmetrical patterns or mirror image patterns. In addition to specifying the events to be repeated, you must also indicate the axis or axes (X or Y or XY are allowed) that the reflection is mirrored across. In addition, you must specify the offset from absolute zero to the line of reflection. You may not mirror another mirror event, or mirror a rotate event. Consider the figure below:

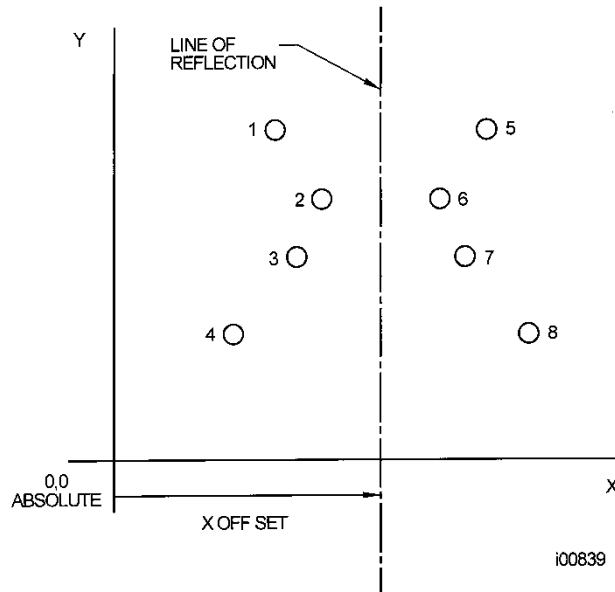

FIGURE 7.3.6.2 Holes 1-4 are mirrored across the Y axis to 5-8, respectively, about a line X OFFSET from X=absolute 0

Press the **SUB** soft key to call up the Repeat, Rotate and Mirror options.

7.3.7 Finishing Teach Events

Teach events are either POSN/DRILL or MILL events that are originated in the DRO Mode (see Section 6.5).

The Teach events that are started in the DRO Mode must be finished in the Program Mode before running. Teach events are of these different types:

TEACH POSN/DRILL - See Section 7.3.1 for a description of Position/Drill event prompts.

TEACH MILL - a straight line that specifies the beginning and the end. When TEACH MILL events are defined using the CONT MILL softkey, the prompts for information that cannot change will be suppressed. See Section 7.3.2 for a description of Mill event prompts.

When a Teach event is unfinished, the event header will appear in purple. Once all the prompts are completed, the word "Teach" will disappear. The event will become a normal POSN DRILL or MILL event.

7.4 Programming Events – (3-axis mode)

The following events are found in the TRAK KMX machine when running in 3-axis mode.

7.4.1 Posn Drill

When you press the POSN/DRILL key, you choose between the following:

- **Posn:** a single position.
- **Drill:** a single drill event. Press Type to adjust type of pecks.
- **Bolt Hole:** a series of positions spaced evenly around a circle.
- **Pause:** this event allows you to pause the program at a certain event. When program the Z will move up to Z retract. The user will have to press GO to continue the program.

7.4.2 Mill Event

This event is the same as in 2 axis mode except, you must program Z information.

7.4.3 Arc Event

This event is the same as in 2 axis mode, except you must program Z information.

7.4.4 Pocket Event

These events are the same as in 2 axis mode, except you must program Z information.

7.4.5 Profile Event

These events are the same as in the 2-axis mode, except you must program the Z information.

7.4.6 Subroutine Events

These events are the same as in 2 axis mode, except you can offset the Z rapid and Z depth.

7.4.7 Finishing Teach Events

The TEACH event is the same as what is found in 2 axis mode, except you will need to fill in your Z rapid, Z end or depth and Z feedrate.

7.5 Prompts Used to Define the Events

The following prompts are encountered in programming the events.

Holes - the number of holes in the bolt hole pattern.

Angle - the location of the first hole to be machined in a Bolt Hole event. It is the angle from the positive X axis (that is, 3 o'clock) to the hole. The positive angle is measured counterclockwise from 0.000 to 359.999 degrees. The angle of rotation in subroutine and copy events.

Conrad - There are two meanings to Conrad:

1. The connecting radius between line or arc being programmed and the next line or arc event. Simply enter the radius value at this prompt and the ProtoTRAK KMX will figure the tool path to go from one event to the next with a

connecting radius. If no radius is desired, or if you are programming the last event, enter 0 by pressing the INC SET or ABS SET key without a number value.

2. The corner radius in a rectangular pocket or PROFILE. The radius is tangential.

Continue - to tell the ProtoTRAK KMX if the event is continuous to the next event(s) to be programmed. This saves inputs needed to define a profile. If the event is programmed with a Yes, for continue, then X begin, Y begin, Tool Offset, Feedrate and Tool # will not be prompted in the next one.

Direction - for an arc or circle, the direction is clockwise or counterclockwise.

Feedrate - the milling feedrate in in/min from .1 to 99.9 or in mm/min from 5 to 2500.

Fin cut - for a pocket or profile, the width of the finish cut. If 0 is input, there will be no finish cut.

Radius - the radius of the bolt hole pattern, arc or circle.

Tool # - the number you assign to identify the tool.

Tool Diameter - the diameter of the tool. See the note on finish cuts later in this section.

Tool offset - the selection of the tool offset, right, left or center relative to the programmed edge and tool movement.

X or Y - the X or Y dimension, may be defined in absolute or incremental reference.

X Begin or **Y Begin** - the X or Y beginning point of the line or arc.

X Center or **Y Center** - the X or Y dimension of the center of the bolt hole pattern, arc or circle.

X End or **Y End** - the X or Y ending point of the line or arc.

X1, Y1, and X3, Y3 - the X and Y dimensions for the opposite corners on a rectangular pocket, profile or face mill.

Prompts unique to the Subroutine and Copy events:

Cutting Order – select to cut from begin to end or end to begin on mirrored events.

First Event # - the first event to be repeated.

Last Event # - the last event to be repeated. If only one event is to be repeated, the First and Last events will be the same number.

Mirror Axis – selection of axis to be mirrored across.

X Offset - the incremental X offset from the event to be repeated.

Y Offset - the incremental Y offset from the event to be repeated.

Repeats - the number of times the events are to be repeated up to 99.

The following prompts pertain to the 3-axis mode.

Z Rapid – this is defined as the location from which the machine transitions from rapid feedrate to the programmed feedrate in your event. Typically this value is set 0.1” or 2.5 mm above the work piece.

Z End and Z Depth – this is defined as the depth you wish the Z axis to feed down to. For example, if you wish to drill a 1” deep hole, you would enter -1.0000” ABS.

of Pecks – this is how many moves the Z will move up and down when drilling a hole. The pecks are variable, which means the first peck will remove more material than the next peck and so on. Select “TYPE” to change pecks to be variable, fixed or chip break.

Z Feedrate – this is the feedrate the Z axis will move down at.

Z Rapid Offset – this is the Z rapid offset you want to apply to your repeat event. If you program 0 INC, the Z rapid will be the same as your previous event.

Z Offset – this is the Z offset you wish to apply from your previous Z end or Z depth. If you program 0 INC, the control will cut at the same depth as the previous event.

Drill or Bore – select if you want to rapid out of the hole (drill) or feed out (bore).

Passes – the number of cycles to machine to the final depth.

Entry Mode – choose between a zig-zag ramp and a plunge.

Prompts for AGE programming are defined in Section 8.

7.6 Assumed Tool Offset, Feedrate, and Tool #

When the INC SET key is pressed, the ProtoTRAK KMX will automatically program the following for these prompts:

TOOL OFFSET: for a Mill or Arc Event, same as the last event if that event was a Mill or Arc Event, otherwise, Tool Center.

FEEDRATE: same as last event if that event was a Mill, Arc, Pocket, or Profile.

TOOL #: same as last event, or Tool 1 in the first event.

DRILL OR BORE: Drill

PECKS: 1 peck

CONRAD: 0

You may change these assumed inputs by simply inputting the correct data when the event is programmed.

7.7 Incremental Reference Position

When X and Y data for the beginning position of any event are input as incremental data, this increment must be measured from some known point in the previous event. Following are the positions for each event type from which the incremental moves are made in the subsequent event:

POSITION/DRILL: X and Y programmed

BOLT HOLE: X CENTER and Y CENTER programmed

MILL: X END and Y END programmed

ARC: X END and Y END programmed

IRREGULAR POCKET or PROFILE: X and Y Begin of the programmed leg

CIRCLE POCKET or PROFILE: X CENTER and Y CENTER programmed

RECTANGLE POCKET or PROFILE: X1 and Y1 corner programmed position

REPEAT, ROTATE or MIRROR: The appropriate reference position for the event prior to the first event that was repeated.

Note - For 3-axis programs, the Z rapid, Z end or depth and taken from the previous event.

7.8 Finish Cuts

The Pocket and Profile events are designed with built-in finish cut routines because they are complete, stand-alone pieces of geometry. Shapes machined with a series of Mill or Arc events don't have an automatic routine for making finish cuts.

Instead, it is very easy to get a finish pass by overstating the size of the tool for the events in the initial pass, and then using a Repeat Event and programming a new tool with the actual size of the tool.

For the first pass, the cutter will be positioned away from the final cut half the amount of the difference between the actual size of the cutter and the diameter you put in. When the Repeat Events are run, the same cutter will be positioned correctly to do the final pass to size.

7.9 Look

You can look at part graphics while in the Program Mode. At any time an event is finished programming and the Select Event prompt appears in the conversation line, simply press the LOOK hard key. The programmed events are automatically sized so that everything fits on the screen.

To return to the programming, press the RETURN softkey.

The part graphics are useful for checking what you have programmed so far. Certain kinds of programming mistakes are not caught by the graphics. These will surface when running the program.

8.0 Program Mode - The Auto Geometry Engine (A.G.E.) Programming

When you program an Irregular Pocket (Section 7.3.4) or an Irregular Profile (Section 7.3.5) the Auto Geometry Engine, or A.G.E. is automatically started.

The A.G.E. is powerful software that works behind the easy-to-use geometry programming of the ProtoTRAK KMX CNC. It is treated in its own section because it works differently than the other event types. Unlike other events, the A.G.E. allows you to:

- Enter the data you know, and skip the prompts you don't.
- Use different types of data (like angles) that may be available from the print.
- Enter guesses for the X and Y ends and centers not available on the print to aid in the automatic calculation of points you need.

With the A.G.E., you can easily overcome limitations in the data the print provides without having to spend time in laborious calculations.

8.1 Starting the A.G.E.

The A.G.E. is started automatically when you enter the Irregular Pocket or Irregular Profile event. The first set of prompts you encounter will be the header information. Once that information is entered, you will see the following screen:

PROG			COARSE	3 AXIS	INCH
EVENT 1	IRR PROFILE		EVENT 2		A.G.E. MILL
X BEGIN	0.0000	abs			A.G.E. ARC
Y BEGIN	0.0000	abs			
Z RAPID	0.0500	abs			
Z END	-0.2500	abs			
TOOL OFFSET	RIGHT				
# PASSES	2				
FIN CUT	0.0100				
Z FEEDRATE	4.0				
XYZ FEEDRATE	15.0				
FIN FEEDRATE	10.0				
TOOL #	1				END A.G.E.
					ABORT A.G.E.

FIGURE 8.1 Once the profile header screen is finished, you choose between an A.G.E. Mill and an A.G.E. Arc to define the shape

Where:

A.G.E. Mill: A straight line from one X Y point to another.

A.G.E. Arc: Any part of a circle.

End A.G.E.: Ends the A.G.E. programming for the Irregular Pocket or Irregular Profile.

Abort A.G.E.: Aborts all A.G.E. events. The data for all the events is lost.

8.2 A.G.E. Mill Prompts

Press the A.G.E. Mill key.

PROG			COARSE	3 AXIS	INCH
EVENT 1	IRR PROFILE		EVENT 2	A.G.E. MILL	Not OK
X BEGIN	0.0000 abs		TANGENT		INSERT EVENT
Y BEGIN	0.0000 abs		X END	0.0000 abs	DELETE EVENT
Z RAPID	0.0500 abs		Y END		PAGE FWD
Z END	-0.2500 abs		CONRAD		PAGE BACK
TOOL OFFSET	RIGHT		LENGTH		GUESS
# PASSES	2		LINE ANGLE		
FIN CUT	0.0100				
Z FEEDRATE	4.0				
XYZ FEEDRATE	15.0				
FIN FEEDRATE	10.0				
TOOL #	1				
Y END : █					

FIGURE 8.2 A.G.E. Mill prompts. Enter what you know, skip or guess the ones you don't.

Prompts in A.G.E. Mill programming:

Tangent: this refers to the tangency of the mill to the previous event. See Section 8.10 for a discussion of tangency.

X END: is the X dimension to the end of the mill cut; incremental is X Begin

Y END: is the Y dimension to the end of the mill cut; incremental is Y Begin

CONRAD: is the dimension of a tangential radius to the next event

LENGTH: is the length of the mill from beginning to end

LINE ANGLE: is the angle of this mill line (moving from begin to end) measured counterclockwise from the positive X axis (that is 3 o'clock)

GUESS: This softkey will appear when the prompt is on X or Y dimensioned data. Press the Guess key before you press INC SET or ABS SET to enter the data as a guess. See Section 8.7 for using Guess.

8.3 A.G.E. Arc Prompts

Press the A.G.E. ARC key.

Prompts in A.G.E. Arc programming:

Tangent: this refers to the tangency of the arc to the previous event. See Section 8.11 for a discussion of tangency.

DIRECTION: is the clockwise (input 1), or counterclockwise (input 2) direction of the arc

X END: is the X dimension to the end of the arc cut; incremental is from X Begin

Y END: is the Y dimension to the end of the arc cut; incremental is from Y Begin

X CENTER: is the X dimension to the center of the arc; incremental is from X End

Y CENTER: is the Y dimension to the center of the arc; incremental is from Y End

CONRAD: is the dimension of a tangential radius to the next event

RADIUS: is the radius of the arc

CHORD ANGLE: is the angle spanned by the arc

In addition to the normal Softkeys, this additional one will appear in A.G.E. Arc programming:

GUESS: this softkey will appear when the prompt is on X or Y dimensioned data. Press the Guess key before you press ABS SET to enter the data as a guess. See Section 8.7

8.4 Skipping Over Prompts

In the A.G.E., events don't have to be fully defined before you can go to the next one. You can skip the data you don't know by using the Up or Down arrow keys. After you press the Down Arrow key at the last prompt, the event will move to the left side of the screen and the Select Event screen will appear.

When skipping over prompts or editing, always use the Up and Down arrow keys. Using INC SET or ABS SET will change the data.

If you want the event back on the right side, use the UP arrow key.

8.5 The OK/NOT OK Flag

Each A.G.E. event has a flag that tells you if it has been fully defined. Sometimes data from later events is needed to define previous events. To the immediate right of the event type, the words OK or NOT OK appear, depending on whether that particular event is defined.

Once the OK flag appears for the event, you do not need to enter more information. Skip past the rest of the prompts with the up/down arrow keys.

If you leave the Program Mode and then return, pressing the GO TO END softkey will take you automatically to the first NOT OK event.

8.6 Ending A.G.E.

Any time all the events of an Irregular Profile are OK, the A.G.E. may be ended. If you are programming an Irregular Pocket, there is an additional requirement that must be satisfied before the A.G.E. may be ended: the X and Y end point of the last event must be the same as the X and Y beginning point, so that the pocket is closed. Otherwise, the ProtoTRAK KMX CNC cannot program the tool path to clear the pocket.

The Irregular Profile has no such restriction since profiles may be open or closed.

Once the A.G.E. is ended, the Irregular Pocket or Irregular Profile event is complete and you may then choose from all the programming canned cycles from the Select an Event screen. To reopen the A.G.E. Profile or Pocket, simply use the up arrow key or the PAGE FWD or PAGE BACK softkeys to position on of the A.G.E. events on the right side of the screen. You may edit or insert other events.

8.7 Guessing Data

Whenever you are missing X or Y Ends or Centers, you should generally enter a guess.

Guessed data is treated differently by the ProtoTRAK KMX CNC than regular data.

Often, the information you put into the system will allow it to calculate a mathematically correct line or arc that would satisfy the conditions of the hard data you entered. This line or arc may yield more than one solution to the particular point you are looking for. That is where the Guess comes in: the A.G.E. uses the guess to choose from the mathematically possible solutions. In most cases, your guesses do not have to be very precise. The smaller the lines or arcs, the more precise the guess should be.

Guesses should always be entered as absolute dimensions. Once entered, the guessed data is green and there is a 'G' next to it. Guessed data will be labeled this way in all the events that are flagged NOT OK. Once an event is OK, the guessed data will be replaced by calculated data. If you wish to edit your guesses, placing it on the right side of the screen will cause your original guessed data to reappear.

8.8 Calculated Data

Prompts that are skipped or for which guesses are entered may be replaced by data calculated by the ProtoTRAK KMX CNC. Calculated data is shown in red in order to distinguish it from the data that you entered. You cannot edit calculated data, but you may edit your original input. By putting the event with the calculated data on the right side of the screen, you may position the cursor to the prompt and re-input the data.

8.9 Arcs and Conrads

If the print is missing a lot of data, it may be desirable to program arcs as separate events where possible. This gives the system more information to work with.

8.10 Tangency

Tangency can occur between a mill and arc or an arc and arc. Specifically it means that the two events share one and only one point. You would answer yes to the TANGENCY prompt if the event you are programming is tangent to the **previous** event. The information that events are tangent helps the Auto Geometry Engine calculate other dimensions.

You can often tell by looking at the print if events are tangent: tangent intersections tend to blend smoothly, without a sharp corner.

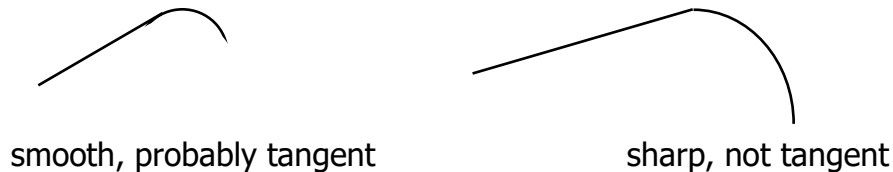

For the A.G.E., the tangent mill or arc is assumed to continue in the same direction, and not double back on the previous event:



9.0 Changing or Correcting Programs

In the Program Mode, you can easily correct mistakes or make changes to the program.

9.1 Deleting a Partially Programmed Event

If you wish to not program an event (or start over) after you have started to program, press the DELETE EVENT softkey and the screen will revert to the "Select Event" prompt.

9.2 Editing Data while Programming an Event

All data is entered by pressing the appropriate numeric keys and pressing INC SET or ABS SET. If you enter an incorrect number before you press INC SET or ABS SET you may clear the number by pressing restore. Then, input the correct number and press SET.

If incorrect data has been entered and SET, you may correct it as you are still programming that same event by pressing the arrow up or arrow down keys to the right of the LCD screen until the incorrect data is highlighted and shown in the conversation line. Enter the correct number and SET. The ProtoTRAK KMX will not allow you to skip past prompts (by pressing an arrow key) that need to be entered to complete an event.

9.3 Editing Previously Programmed Events

From the Select Event screen you may press the arrow up key to the right of the LCD screen and the program will move back one event. From that point, you will have the following softkey options:

INSERT EVENT allows you to insert a new event between the two shown on the left and right side of the screen. When you press INSERT EVENT the screen will revert to the Select Event screen and you may program the new added event as you would any other. Subsequent events will be renumbered accordingly.

DELETE EVENT allows you to delete the event on the right side of the screen. Subsequent events will be renumbered accordingly.

PAGE FWD (Forward) indexes the event forward by one.

PAGE BACK indexes the event back by one.

To edit groups of events, go to Event 0, press the DELETE EVENTS soft key and input and SET the first and last events to be deleted.

9.4 Changing a Part Number (making a copy of a program)

You may want to rename a part program, or make a copy of a program using a different name. The latter may be useful if you have a new part to do that is similar to a part that you already have programmed. Make a copy of the program by saving it under a new part number and then make the changes.

You can rename a part program in three ways:

- Press the PAGE BACK key past the first event until you are at Event 0 and the prompt for Program Part Number. Enter the new part number and press SET.
- Exit the Program Mode by pressing Mode and then re-enter it. You will have an opportunity to rename it then.
- Rename it in the Program In/Out Mode. After pressing the PROG IN/OUT key, simply enter the new part number and press SAVE.

If the previous part program is already stored on the system internal storage it will remain in storage under the previous part number with the same information it had the last time it was stored.

9.5 Saving Changes to a Program

If a program is opened from storage and changes are made, the program must be stored again in Prog In/Out Mode for the changes to be preserved in the stored copy. Programs in current memory may be changed and run with the changes, but unless they are saved again, the changes made will be lost when the program is cleared from current memory. If you intend to keep the changes made to your program it is a good practice to store the program occasionally in case a power loss causes the program to be ejected from current memory.

9.6 Erasing an Entire Program

To erase an entire program from *current memory*, go to the Program In/Out Mode and press ERASE CUR. You will be prompted "Are you sure you want to erase this program?" You may want to store the program before you clear it from current memory. If it is not stored, pressing YES will permanently erase the program.

To erase an entire program from the internal *storage*, input the part number and then press DELETE. Programs in current memory will not be affected by this operation. You could erase a part number on the internal storage and the program in current memory will remain in current memory, even if it has the same part number as the one just erased.

Programs in current memory will automatically be erased when another program is retrieved from storage.

10.0 SET UP/RUN Mode

The Set Up Mode contains the tool table, tool path, home, Verify and service codes.

SET-UP				3 AXIS	INCH
					TOOL TABLE
					TOOL PATH
					HOME
					VERIFY PART
					SERV CODES

10.1 TOOL TABLE

The tool table is where you set your Z retract, set the lengths of your tools and also where you can set Z modifiers for each tool. The following example has 4 tools in the program. The tool table looks as follows:

SET-UP				COARSE	3 AXIS	INCH
<u>TOOL #</u>	<u>DIAMETER</u>	<u>Z OFFSET</u>	<u>Z MODIFIER</u>	<u>TOOL TYPE</u>		
	<u>Z RETRACT</u>	<u>SET</u>			JOG	
1	0.5000	BASE	0.0000		DATA LEFT	
2	0.3750	1.1950	0.0000		DATA RIGHT	
3	1.0000	-0.2367	0.0000		ERASE DATA	
					RETURN	
TOOL #3 Z MODIFIER :						0.0000

Z Retract – this is the location where the machines head or quill will go each time you change tools. Once you set this location, the prompt above will change from NOT SET to SET. You can however change this location any time you want by jogging the head to the new location and pressing SET. We recommend you set your Z retract higher than your longest tool so you won't have problems adding or removing tools.

Z Offset – this is used to calculate the difference in length between each of your tools. The control automatically applies this offset when you change tools. The first tool in your program is what we call the base tool, which simply means all other tools are measured relative to this. We recommend that you touch off a fixed surface (like the top of the vise) when touching your tools off. You then must touch each of your other tools off of the same surface. The first tool will not show a number when you touch it off, but the rest of the tools will show how much longer or shorter they are relative to the first tool.

In 2 axis mode on the KMX, you can also set Z offsets if you choose. These offsets will be applied when you press GO after loading a new tool. The Z readout will update to the new value. Most people just zero out each tool in RUN mode after you load the tool in the spindle.

The 1.1950 offset for Tool 2 means this tool is this much longer than your base tool. The -0.2367 offsets for Tool 3 means this tool is shorter by this amount.

It should be noted that if your base tool breaks or is replaced, you must touch off all of your tools again.

Z Modifier – this allows you to tweak the offset of a given tool. For example, let's say you cut a pocket and the pocket was shallow by 0.005". You could enter a -0.005" Z modifier for that tool and cut the pocket again. Positive modifiers might be used when you are trying to hold a critical depth. You may want to cut the part shallow and sneak up on this dimension.

WARNING

Note, tool tables are not saved with the program. If you turn the ProtoTRAK KMX off the tool table will be lost even if the part program was saved on a thumb drive through the Program In/Out Mode. Save Temp is an exception to this rule See 12.4.1.

Erase Tool Data – this allows you to erase all tool table data. Press key and answer Yes.

10.2 TOOL PATH

Tool path is used to verify how your tools will move through the program. The following is what the screen will look like.

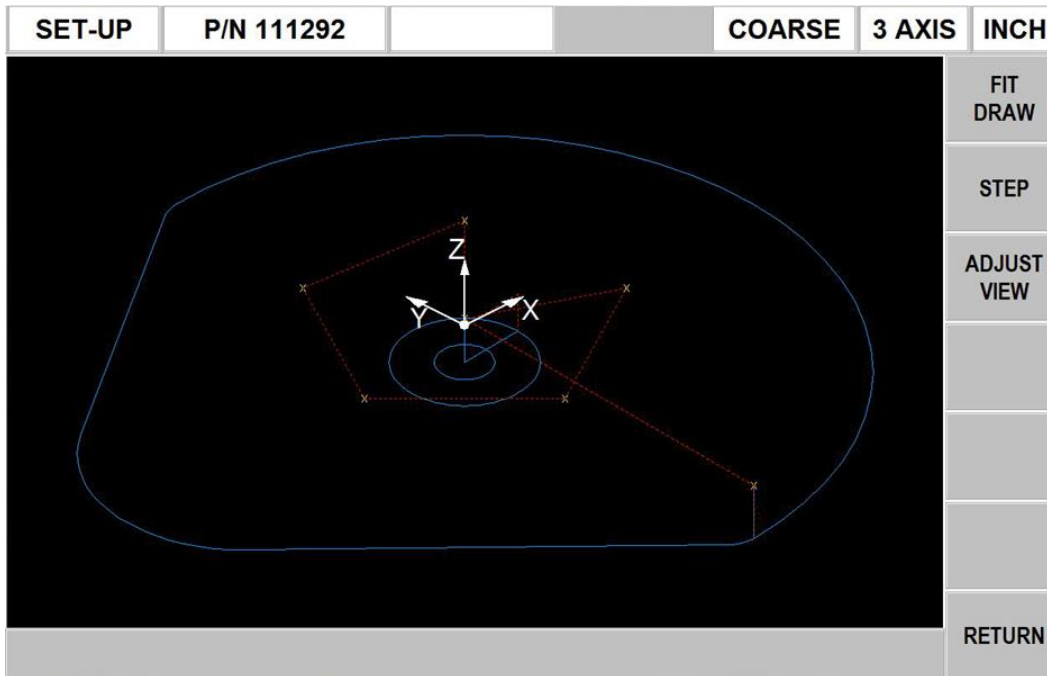

FIGURE 10.2 *The Tool Path graphics show the program and tool positions*

Most programming errors that would prevent the program from running are detected when the tool path graphics are selected. For example, if you were to have omitted a minus sign from a Z End dimension, the system would give you an error message that the Z End should not be higher than the Z Rapid.

The displayed graphic is automatically sized to fit the screen and an icon that represents the X, Y and Z orientation is placed at the program's absolute 0 reference point. The path shown on the screen represents the center of the tool.

- Position and drill events are drawn in yellow.
- Rapid moves are in red.
- Programmed geometry is in blue.

FIT DRAW – this allows the user to draw the complete part if the user is using the STEP feature to move through the program.

STEP – allows the user to move step by step through the program. Press repeatedly.

ADJUST VIEW – allows you to adjust the tool path view. See below.

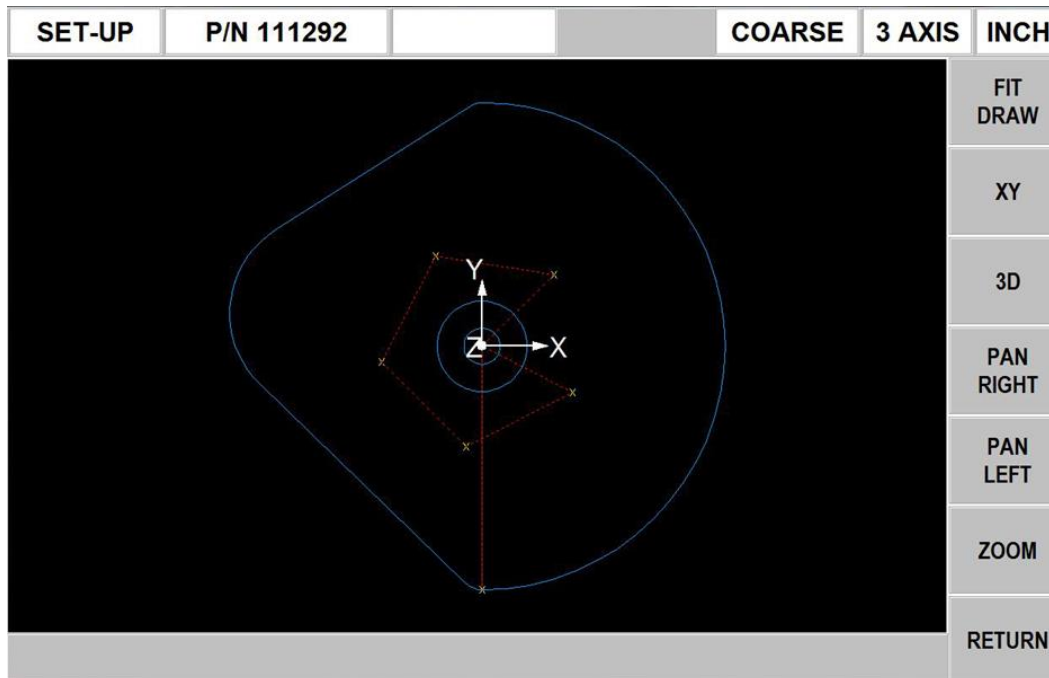

FIT DRAW: will re-draw, automatically sizing to fit the screen

XY: displays tool path in XY view

3D: displays tool path in 3d view

Pan Right: shifts the tool path display to the right

Pan Left: shifts the tool path display to the left

Up Arrow: shifts the tool path display up

Down Arrow: shifts the tool path display down

Zoom: zooms in to see more detail

Return: returns to tool path screen

10.3 Setting Home

Home is the X/Y location relative to the program absolute zero that you want the table to move to just before a tool change and at the end of run.

Press HOME from the initial SET UP screen and input and SET the values you want.

10.4 STEP UP & STEP DOWN – 3-Axis Mills in 2-Axis Mode

The STEP UP & STEP DOWN feature is used only on the 3-axis bed mills when running in 2 axis mode. This feature allows the user to move the head up and down 1" with each press. This may be required in run mode when you need to change tools and there is not enough room to remove or add the next tool.

10.5 Verify

Verify Part is used to see a solid graphical representation of the programmed part. It should be used, along with Tool Path, as a tool to verify the part is programmed correctly.

Press VERIFY PART and the soft keys will change to DEFINE STOCK and MAKE PART. You may, but do not have to, define the size of your stock. If you do not, the ProtoTRAK will assume the stock is a cubic piece of material slightly larger than your part. If you choose to define your stock, press DEFINE STOCK and input the X, Y and Z absolute dimensions relative to your program absolute zero.

Press MAKE PART to see the solid graphical representation of the part. Please note that you may have to be patient, especially for complex parts with many events. A progress bar will show you the computation status. Also note that the optional offline KMX software will display the actual machining of the part and with very short delays. Please go to Section 7.1.1 to input part depth (Z) information for 2-axis programs.

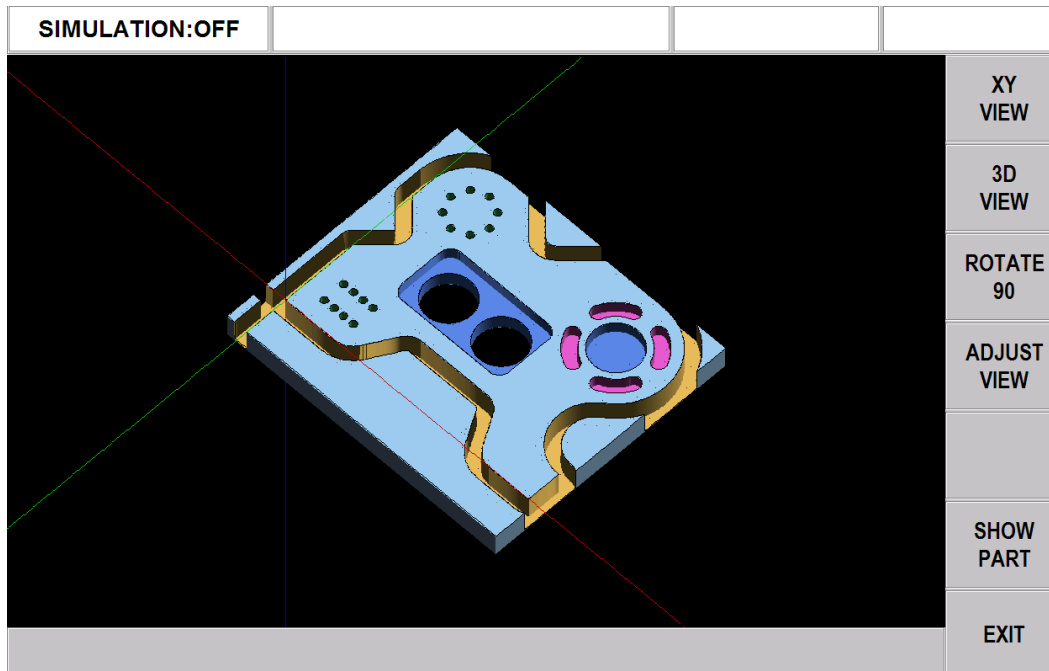

10.6 Service Codes

Please see Section 14.0 for User and Service Codes.

11.0 Program Run Mode

11.1 Setting Up

Before you can run your program, you must set your part absolute position in the DRO Mode. The CNC will use this absolute position as a reference for running your program.

When running a 3-axis program, you can touch off your Z zero using any of the tools that are part of your program. You must, however, make sure the tool in the spindle is the tool that the control thinks is in the spindle. The tool the control thinks is in the spindle can be found in the status line.

11.2 Starting

After setting up in the DRO Mode, go into the Run Mode. You will see this screen:

RUN	P/N 111292	TOOL# 1	COARSE	3 AXIS	INCH
					START
X	0.0000	ABS	START EVENT #		
Y	0.0000	ABS			
Z	0.0000	ABS			
Feed Rate <input type="text" value="0.0"/>		Override <input type="text" value="100"/>			

To start the program, select between START and START EVENT#.

- START – starts running the program from the beginning.
- START EVENT # – starts running the program from an event in the middle. If you press this key you will be prompted to enter the event number for where to start.

11.3 Display Messages in Program Run

EVENT # and type: This is the current or next event to be run.

REPEAT: the number of the repeat for repeat events.

FEEDRATE: the actual table feedrate.

OVERRIDE: the feedrate override, controlled by pressing the up or down arrow keys above and below the soft keys.

When you have started by any of the means above, the display will show:

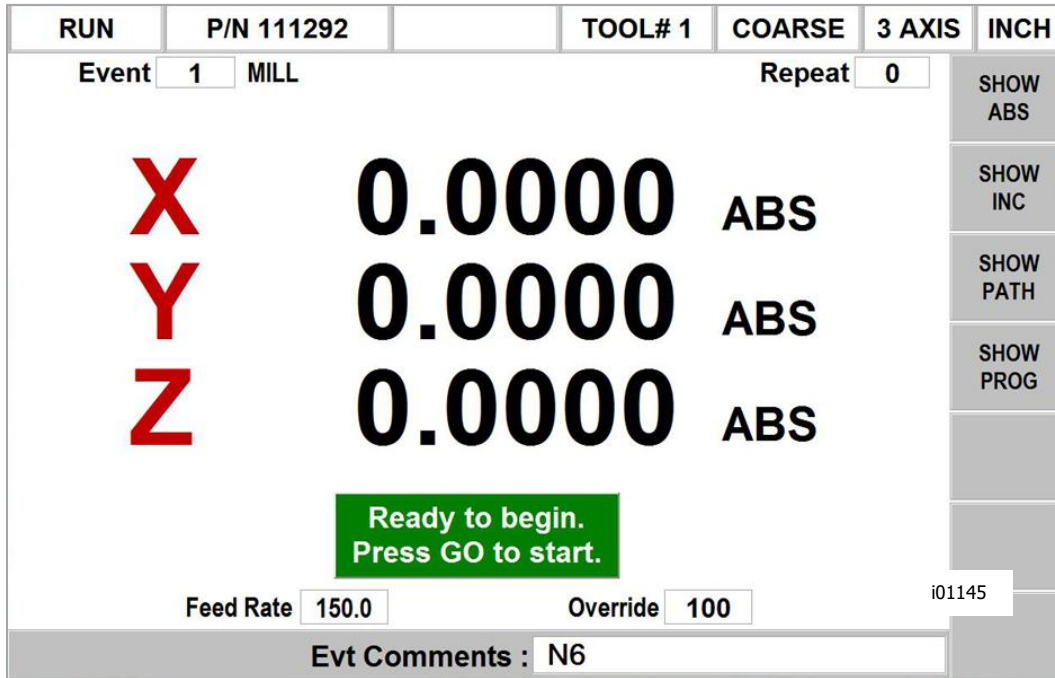

FIGURE 11.3 Press the GO feed key to start running.

Where:

The part number being run is shown in the status line.

- The event number and type (and the repeat number, if applicable) being run is shown at the top of the screen.
- The current X, Y, Z absolute positions are shown in the information area.
- The **SHOW ABS** soft key (which is automatically assumed if one of the other 3 show keys are not selected) will show the absolute X, Y, Z positions as the part is run.
- The **SHOW INC** soft key will show the incremental (or distance to go within the event) X, Y, Z positions as the part is run.
- The **SHOW PATH** soft key will show the tool path graphics as the part is run.
- The **SHOW PROG** soft key will show the programmed data for the event being run, and the next event as the part is run.

The run procedure is very simple. Follow the instructions on the conversation line and proceed by pressing the GO key.

Once the STOP hard key is pressed, additional softkeys will be available:

TRAKing – select this softkey to control the X, Y and Z programmed motion with the table or saddle handwheel. See section 11.7 below. The TRAKing/Electronic Handwheels Option must be active for this function.

CNC Run – select this softkey to start the CNC run after TRAKing and STOP.

11.4 Program Run Prompts

During Program Run, messages that direct you will appear in a green box. The ProtoTRAK KMX will wait until you press Go before moving the servo motors. What you need to do is obvious in most cases. Below is some supplemental information.

Check Z: Means to make sure the quill is properly retracted because the next move will be rapid. Press GO to continue. Not applicable to 3-axis mode.

Set Z: Means to drill and retract the quill for a drilling operation, or set and lock the quill to the proper depth for a milling cut. Press GO to continue. Not applicable to 3-axis mode.

Load Tool (green box): The ProtoTRAK prompts you each time you need to change a tool. In 2 axis mode, you can rezero out this new tool at any time by lowering the quill to the top of your part and pressing Z = 0 ABS SET. The setting of Z zero is not applicable in 3-axis mode.

Run Over: Means that the program run is complete. If you are running a second part that will be fixtured/clamped in the exact same position as the first part, you do not need to relocate the absolute 0 and restart. Instead, press the NEXT PART softkey when the conversation line states "Run Over" and the system will proceed directly to Event 1.

11.5 Stop

At any time, pressing the STOP key will halt the program. This freezes the program at that point. To continue, press the GO key.

11.6 Feedrate Override

The run feedrate may be changed at any time by pressing the up and down arrow keys to the right of the LCD screen. Each press changes the programmed feedrate (as well as the rapid feedrate) in 10% increments. The maximum overrides are from 10% to 150% of programmed feedrates.

11.7 TRAKing / Electronic Handwheel Option

The TRAKing / Electronic Handwheel feature is optional for models except for upgrades on DPM 5 and B5 bed mills where the feature already exists.

TRAKing is a special kind of CNC run. When you press the TRAKing softkey, the programmed head, table and saddle motion is simultaneously controlled by turning the table or saddle electronic handwheel. Moving the X or Y handwheel in the clockwise direction moves forward through the program; moving counterclockwise moves backward through the program. The spindle must be on in order to TRAK once the head reaches the programmed

Z Rapid position. To TRAK slowly, use the Y handwheel. To TRAK quickly, use the X handwheel.

TRAKing comes in handy whenever you are a little unsure about any aspect of your program or set-up. For example, on the first run of a part - instead of pressing GO and holding your hand on the stop button, use TRAKing to bring the tool to the part while you watch the tool and DRO. Once assured that everything is all right, press STOP and get into CNC run.

11.7.1 TRAKing in Two-Axis CNC

When running the ProtoTRAK KMX as a two-axis CNC, TRAKing works with the manual operation of the Z or head. The tool may be put in position when the messages "Set Z" or "Check Z" appear. When TRAKing through an XY move, the Z-axis handwheel is not active.

11.8 Data Errors

A program must make sense geometrically. For example, you can't machine a .250 inch diameter circular pocket using a .500 inch end mill. Data errors will nearly always be detected when the ProtoTRAK KMX runs through a program--either as a tool path or on an actual part run.

The Error message displays the error number (not necessarily important to you) and the event where the error was detected. This is not necessarily the event that is in error since the system often "looks ahead" to make sure there is compatibility from one event to another.

In addition, an explanation is given for each data error type as well as a suggested solution.

11.9 Fault Messages

The ProtoTRAK performs a number of automatic checks or self-diagnostics. If problems are found it will signal you through the display.

12.0 Program Memory & Storage

The ProtoTRAK KMX can only have one program at a time in current memory. This is the program you see when you enter the program mode and is the one that is available to run.

Programs may be stored for future use on a thumb drive in one of either USB ports on the upper back of the ProtoTRAK KMX.

Part programs are saved to storage or opened from storage in the Program In/Out Mode. When programs are transferred back and forth from current memory and storage, they stay in both locations unless erased or cleared. In other words, opening a program from internal storage into the current memory does not remove it from the internal storage. Only deleting the program will remove it.

PROG I/O	P/N 111292		COARSE	3 AXIS	INCH
					OPEN
					OPEN TEMP
					SAVE
					DELETE
					ERASE CUR
					RETURN

12.1 Cautions About Opening and Deleting Programs

Care must be taken to keep from losing a program you wish to keep. This can happen two ways.

First, whenever a program is opened, it is loaded into the ProtoTRAK KMX's computer program memory. When this happens, your existing current program is erased. Therefore, if your current program is one you want to keep, be certain to store it before you retrieve another program.

Second, to store a program it must have a part number so that the ProtoTRAK KMX can find it when you want to open it. However, no two programs can have the same part number (how would the system decide which to retrieve?). Therefore, if you store a program with any particular part number, it will automatically erase any other program with that same part number.

In both cases above the ProtoTRAK KMX will give you a warning before erasing or overwriting your program.

12.2 Program Formats and Labeling

The ProtoTRAK family of products has its own unique programming system--one that organizes the program into events rather than codes and blocks. Programs written on the KMX will have the extension .PT4.

The ProtoTRAK KMX will open programs with .PT4 extensions (but error out if they contain Tap Events from the ProtoTRAK SMX) or any programs written on our legacy controls with .MX2 or .MX3 extensions. All .MX2 and .MX3 will automatically be converted to .PT4 programs as they are opened so they are compatible with the ProtoTRAK KMX.

12.3 Opening a Program from the ProtoTRAK KMX Thumb Drive

Press MODE, PROG I/O and OPEN keys. The display will show:

PROG I/O			COARSE	3 AXIS	INCH
0.MX3	111291.CAM	410.MX3	987.MX3		OPEN
000.MX3	111292.CAM	427.MX3	98765.MX3		
00000.MX3	112.MX3	42949.mx3	987654.MX3		COLUMN FWD
007.MX3	1171129.MX3	50333.MX3	988.MX3		
037.MX3	12191302.MX3	50444.MX3	99.MX3		COLUMN BACK
06031301.MX3	12191303.MX3	505.MX3	99999999.MX3		
072703.MX3	123.mx3	50511.MX3			COLUMN FWD
09191301.MX3	1234.MX3	5150.mx3			
096.MX3	1234.PT4	51501.MX3			COLUMN BACK
097.MX3	12345.MX3	54.MX3			
1.MX3	123456.MX3	55.MX3			COLUMN BACK
10.MX3	13782.MX3	57.MX3			
1010.MX3	147258.MX3	577.MX3			COLUMN BACK
10101.MX3	14845.MX3	582.MX3			
10380003.MX3	1900.mx3	67.MX3			COLUMN BACK
11.MX3	2000.MX3	700083.MX3			
11111.MX3	2222.MX3	751.MX3			COLUMN BACK
111111.MX3	321.MX3	752.MX3			
111112.MX3	32158.MX3	875.MX3			COLUMN BACK
11112.MX3	33.mx3	928351.MX3			
					RETURN

- Use Column Forward and Back to move the highlight to the proper column showing the program you wish to open.
- Use the UP and Down Arrow keys to highlight the part number you wish to open.
- Press Open to open your program.
- Press Return to return to the previous screen.

12.3.1 Open Temp

The Open Temp feature allows you to recall the program, all tool information and your X, Y, Z position status that existed when you performed Save Temp (See 12.4.1).

This is very useful if you want to turn your KMX off overnight and return to your job without resetting anything. However, you must be sure that the table has not been moved and the tools have not been adjusted.

To implement, turn on the ProtoTRAK KMX, go to Prog I/O and press Open Temp.

12.4 Saving a Program Onto the ProtoTRAK KMX Thumb Drive

Press MODE, PROG I/O and SAVE keys. The display will show:

PROG I/O	P/N 111292		COARSE	3 AXIS	INCH
0.MX3	11112.MX3	33.mx3	928351.MX3		SAVE
0.PT4	111291.CAM	410.MX3	987.MX3		
000.MX3	111292.CAM	427.MX3	98765.MX3		SAVE TEMP
00000.MX3	112.MX3	42949.mx3	987654.MX3		
007.MX3	1171129.MX3	50333.MX3	988.MX3		COLUMN FWD
037.MX3	12191302.MX3	50444.MX3	99.MX3		
06031301.MX3	12191303.MX3	505.MX3	99999999.MX3		COLUMN BACK
072703.MX3	123.mx3	50511.MX3			
09191301.MX3	1234.MX3	5150.mx3			SAVE AS MX3
096.MX3	1234.PT4	51501.MX3			
097.MX3	12345.MX3	54.MX3			RETURN
1.MX3	123456.MX3	55.MX3			
10.MX3	13782.MX3	57.MX3			
1010.MX3	147258.MX3	577.MX3			
10101.MX3	14845.MX3	582.MX3			
10380003.MX3	1900.mx3	67.MX3			
11.MX3	2000.MX3	700083.MX3			
11111.MX3	2222.MX3	751.MX3			
111111.MX3	321.MX3	752.MX3			
111112.MX3	32158.MX3	875.MX3			
Program Name : 111292					

- Use Column Forward and Back to check the programs that are currently on the thumb drive. Be careful to not duplicate a program number unless you intend to over-write it.
- Press Save to save your program with a .PT4 extension.
- Press Save Temp to save not only your program, but your tool and position data as well, if you want to turn the KMX off and restart as you were later. (See 12.4.1).
- Press Save As .MX2 or .MX3 to save your program so that it can be transferred and run on legacy ProtoTRAKs.
- Press Return to return to the previous screen.

12.4.1 Save Temp Procedure

The Save Temp procedure must be done correctly to assure your ability to restart your job after the KMX has been turned off and without needing to recall your program and reset your tools.

- Go to DRO Mode
- Call out Tool #1
- Load Tool #1 into the spindle
- Move X, Y and Z to their absolute zero position
- Go to Prog I/O
- Press SAVE and then SAVE TEMP

During the time the KMX is off be sure nothing has moved the table or adjusted the tools. If uncertain, reset your absolute zero and/or tool offsets.

12.5 Deleting a Program on Your ProtoTRAK KMX Thumb Drive

Press MODE, PROG I/O, and DELETE keys. The display will show:

PROG I/O	P/N 111292		COARSE	3 AXIS	INCH
0.MX3	111291.CAM	410.MX3	987.MX3		DELETE
000.MX3	111292.CAM	427.MX3	98765.MX3		
00000.MX3	112.MX3	42949.mx3	987654.MX3		COLUMN FWD
007.MX3	1171129.MX3	50333.MX3	988.MX3		
037.MX3	12191302.MX3	50444.MX3	99.MX3		COLUMN BACK
06031301.MX3	12191303.MX3	505.MX3	99999999.MX3		
072703.MX3	123.mx3	50511.MX3			RETURN
09191301.MX3	1234.MX3	5150.mx3			
096.MX3	1234.PT4	51501.MX3			
097.MX3	12345.MX3	54.MX3			
1.MX3	123456.MX3	55.MX3			
10.MX3	13782.MX3	57.MX3			
1010.MX3	147258.MX3	577.MX3			
10101.MX3	14845.MX3	582.MX3			
10380003.MX3	1900.mx3	67.MX3			
11.MX3	2000.MX3	700083.MX3			
11111.MX3	2222.MX3	751.MX3			
111111.MX3	321.MX3	752.MX3			
111112.MX3	32158.MX3	875.MX3			
11112.MX3	33.mx3	928351.MX3			

- Use Column Forward and Back to highlight the proper column showing the program you wish to delete.
- Use the Up and Down Arrow keys to highlight the part number you wish to delete.
- Press Delete to permanently delete the program from the KMX thumb drive.

12.6 Erase Current Program

Erase Program will erase the program from your current memory. You do this to clear current memory in order to write another program.

12.7 Thumb Drive

If you buy the optional thumb drive from Southwestern Industries, it will already be correctly configured. If you use your own please read Section 3.2.2 and create a folder named "KMX Programs" on the drive.

Files may be managed on the thumb drive with your offline computer.

12.8 Opening and Running G-Code and CAM Files

The ProtoTRAK KMX allows you to run G-Code files directly without having them converted to the KMX programming format. This is useful when running large or complex programs. These programs must have a .GCD extension.

The ProtoTRAK KMX will also allow you to bring in a G-Code program and automatically convert it into the KMX programming format. This is useful if you want the simplicity of editing in the KMX format instead of editing G-Codes. It is not useful for large complex G-Code programs. These programs must have a .CAM extension.

Both .GCD and .CAM programs will only operate with a limited set of G-Codes and M-Codes. These are listed below.

G-Code	.GCD	.CAM	Description	Notes
G00	X	X	Position at rapid	
G01	X	X	Linear interpolation	F= Feedrate in ipm
G02	X	X	Circular interpolation - CW	I,J,K are X,Y,Z center points from starting point of arc
G03	X	X	Circular interpolation – CCW	See G02
G04	X		Dwell	P=Number milliseconds
G06	X		Helix – CW	D=Number of revolutions
G07	X		Helix – CCW	See G06
G17	X		Select XY plane	Only apply to G2 and G3
G18	X		Select XZ plane	See G17
G19	X		Select YZ plane	See G17
G20	X	X	Input in inch	Default
G21	X	X	Input in metric	
G40	X	X	Cutter compensation – cancel	
G41	X	X	Cutter compensation – left	
G42	X	X	Cutter compensation – right	
G54 thru G59	X		Select work coordinate	You may only use one per program. Set your offsets in DRO by setting X,Y and Z zero
G61	X		Exact stop mode	
G64	X		Continuous cut mode	

G80	X	X	Canned cycle cancel	
G81	X	X	Drill cycle, counter boring	R=rapid position, Z=final depth
G82	X	X	Drilling cycle with dwell	P=dwell time in milliseconds
G83	X	X	Peck drilling cycle	Q=depth of peck, I=depth of first cut, J=amount per peck, K=min cut
G85	X	X	Boring cycle	
G89	X	X	Boring cycle with dwell	See G82
G90	X	X	Absolute mode	Default
G91	X	X	Incremental mode	
G98	X		Use previous Z position as rapid plane	Default

M-Code	.GCD	.CAM	Description
M00	X	X	Program stop – press GO to proceed
M02	X	X	End of program (no rewind)
M05	X		End of program
M06	X	X	Tool change
M08		X	Coolant on
M09		X	Coolant off
M12		X	Indexer pulse at beginning of event
M20		X	Indexer pulse at end of event
M21	X		Indexer pulse
M30	X		End of program (rewind stop)
M333*	X		Enable low pass filter
M334*	X		Disable low pass filter - default

**The low pass filter is used for applications where higher blocks per second performance is desired, such as for surfacing programs. It will look ahead more blocks of G-code, and blend moves together to achieve smoother motion. Note that when enabled, sharp corners may be rounded off at higher feedrates. When running event programs the KMX runs with this option disabled.*

12.9 Networking

By default, the ProtoTRAK KMX control is set to look for part programs on the first removable USB flash drive that is available. However, this can be changed to a network location by using service code 345. To access this from the MODE screen, press SET UP, followed by SERV CODES soft key, and then type in 345 and press ABS SET.

SERV	P/N 111292		COARSE	3 AXIS	INCH
Code 345 - Set Part Program Location					NETWK SHARE
Device: USB Drive					
Location: USB-Disk\KMX PROGRAMS					
					RETURN

This screen shows the default location of where the KMX control will look for part programs. DEVICE shows whether it is currently looking for programs on the USB drive or the network. LOCATION shows the folder that it will open under PROG I/O. Note that on a USB flash drive, only the "KMX Programs" folder is able to be accessed. It will also be automatically created when saving programs to the USB drive.

To change from USB storage to a network location, press the NETWORK SHARE softkey. The screen will now give you more options to set up your network. If you wish to go back to opening from / saving to the USB flash drive, then press the USB DRIVE soft key.

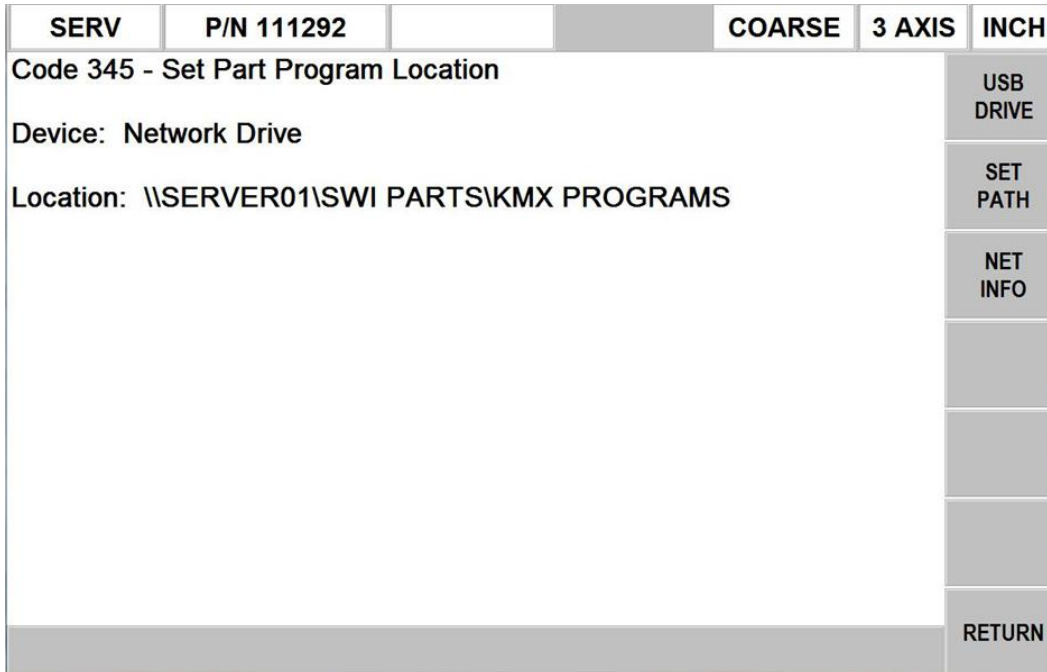

Press the SET PATH softkey to manually type in the network path of the shared folder that you want to open files from.



The path can be typed in by using the Data Left and Right Keys and the Up and Down Arrow keys to scroll through the letters and pressing the ENTER softkey. Use the numeric front panel keys to type in numbers, and then press END when completed. You can also plug in a USB keyboard to type in the path.

Note that you want to make sure that the folder you are accessing is properly being shared so that it is accessible by the ProtoTRAK control.

The NET INFO button can be used to test the path specified, and to help troubleshoot if you find that you are having connectivity issues. When this softkey is used, the ProtoTRAK KMX control will attempt to write a temp file to the defined network location, and then read it back from the same location. It will display the results on the screen.

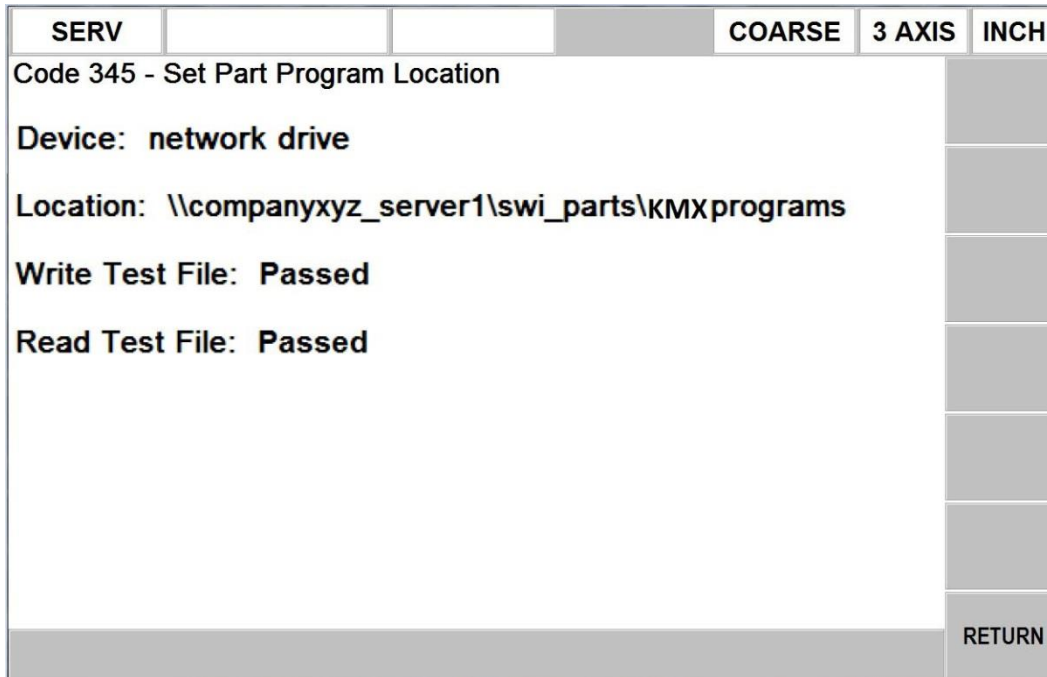

The screen above shows that the control was successfully able to read and write to the specified path.

This next screen shows the result of the same test, except it was not able to properly establish a connection.

SERV			COARSE	3 AXIS	INCH
Code 345 - Set Part Program Location					
Device: network drive					
Location: \\companyxyz_server1\swi_parts\KMXprograms					
Write Test File: Failed					
Read Test File: Failed					
Server: Not found and/or cannot resolve server name					
					RETURN

When this is the case, you should double check the following:

- 1) The Location / path specified is correct. Check spelling, case sensitivity, spaces, etc.
- 2) All your physical connections and devices. This includes Ethernet cables, routers, switches, etc.
- 3) Make sure that location specified is properly being shared, and is accessible by this device.

Network Setup

Our ProtoTRAK KMX control only has the ability to open a network path that is openly being shared, without any username / password restrictions. If this is the case, simply connecting your ProtoTRAK KMX directly to your PC or to a hub or router that the PC is connected to, should be all that is needed in order for this to work.

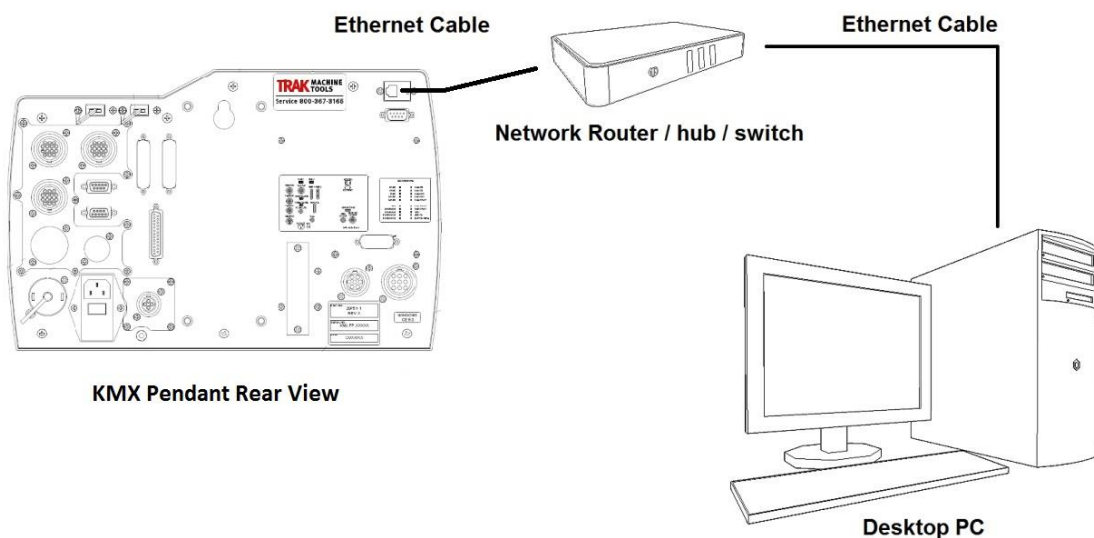

However, if your PC is part of a network where a username and password combination is required, then it is recommended to use a wireless media bridge in order to successfully communicate with your network.

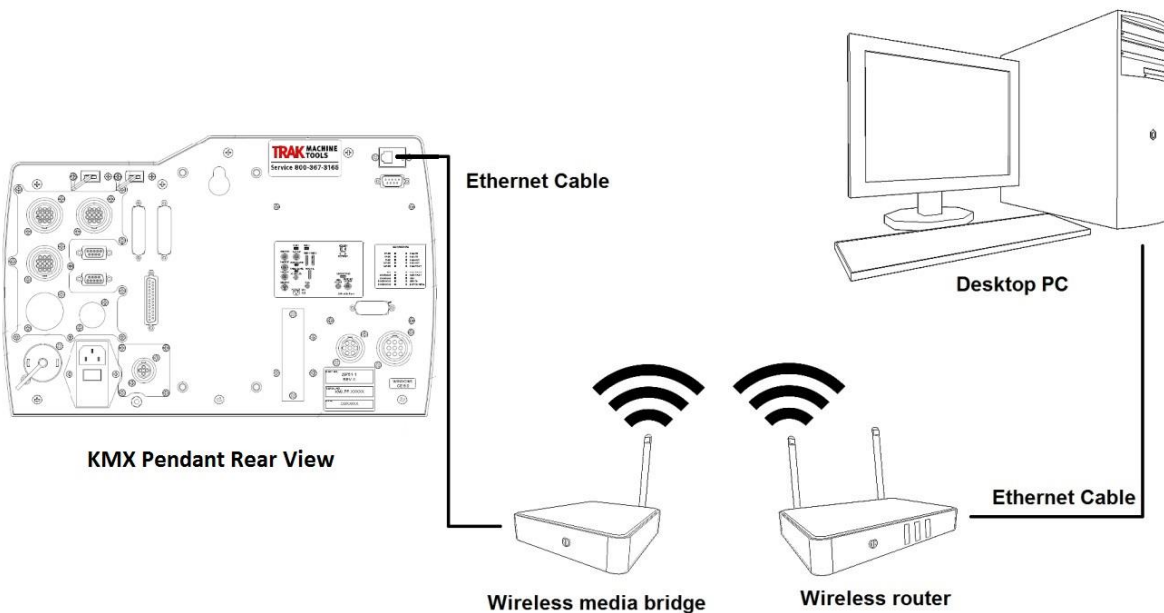

The wireless bridge can be setup to fit the requirements of your network, where you can define a username, password, IP address, workgroup, domain, etc. They are used commonly for devices such as TV's and media players, to accomplish the same task. Instructions on how to do this will vary between models, but they will usually involve

hooking it up to a desktop pc first, logging into the device, following the setup procedure, and then connecting it to the device of your choice.

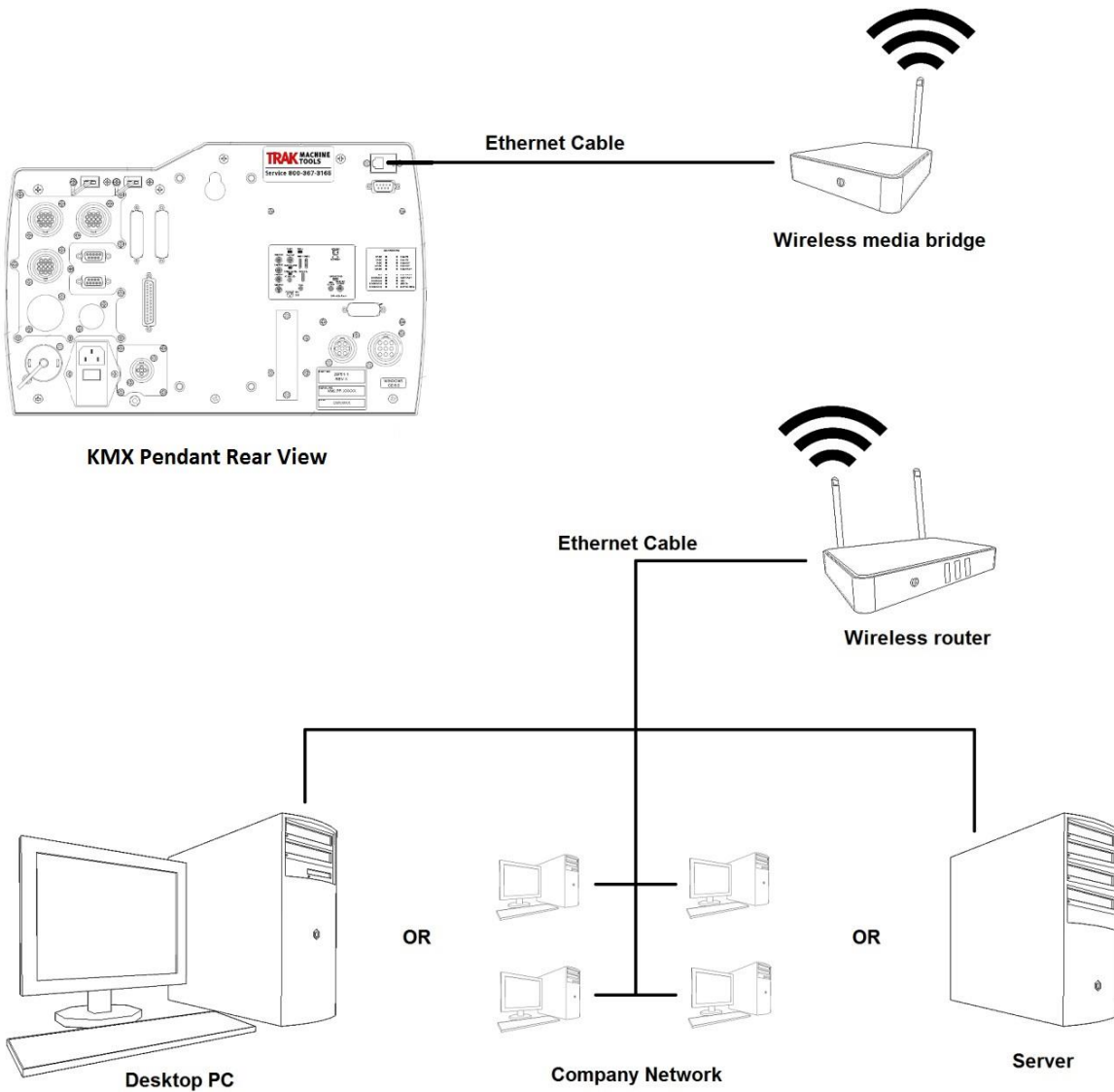

Companies such as Linksys, D-Link, and TRENDnet offer relatively inexpensive media bridges that can accommodate multiple devices.

13.0 Math Help

Prints are, unfortunately, not always drawn and labeled in such a way as to provide all of the points necessary for programming. To minimize this problem, the ProtoTRAK KMX provides a graphic math help function which can be used to automatically calculate points of intersection, centers of arcs, trig functions, square roots, etc.

13.1 Procedure

To enter the Math Help Mode, press MODE and select the MATH HELP soft key. The screen will show:

MATH	INCH
A Line-Line Intersection	A
B Line-Arc and Arc-Arc Intersection	B
C Line-Arc Tangency	C
D Centers, Points, Radius, Angles of Circles	D
E Polar-Cartesian Transformation	E
F Calculator	F
	RETURN

Select from A through E using the softkeys. If, for example, you wish to find the intersection of a straight line and an arc or circle, press the B softkey. The screen will show three choices for finding the intersection of a line with different information given.

If the information you know about the line and arc correspond to Type 13, then select the 13 softkey. The screen will then show:

MATH					INCH	
					TYPE 13:	
					X1	0.0000
					Y1	0.0000
					X2	2.0000
					Y2	0.0000
					X3	0.2500
					Y3	0.2500
					R1	0.0000
R1 : 0.0000					RETURN	

Input the known data in the same way you would program an event. When all of the data is entered, the solution (or solutions if there are more than one) will be shown on the left side of the information area. Use the Up and Down arrow keys to move the highlight.

There are often multiple solutions for geometry problems. For example, in the Type 13 example above, a line will often intersect an arc or circle in two places. In these cases all possible solutions will be calculated and displayed. In most cases a careful inspection of the print and some common sense will tell you which solution applies to your problem.

13.2 Math Help Types

Type #	What you need	What you know
10	Intersection of two lines	<ul style="list-style-type: none"> • 2 points on each line
11	Intersection of two lines	<ul style="list-style-type: none"> • 2 points on one line • 1 point on the other line • angle between the lines
12	Intersection of two lines	<ul style="list-style-type: none"> • 2 points on one line • 1 point on the other line • a radius tangent to both lines <i>when</i> one of the points on the two points known line is also on the radius
13	Intersection of a line and an arc	<ul style="list-style-type: none"> • 2 points on the line • arc center • arc radius
14	Intersection of a line and an arc	<ul style="list-style-type: none"> • 2 points on the line • 2 points on the arc • arc radius
15	Intersection of two arcs	<ul style="list-style-type: none"> • center of each arc • radius of each arc
16	Intersection of a line tangent to two arcs (line does not cross arc centers)	<ul style="list-style-type: none"> • center of each arc • radius of each arc
17	Intersection of a line tangent to an arc	<ul style="list-style-type: none"> • one point on the line • center of the arc • radius of the arc
18	Intersection of a line tangent to two arcs (line crosses arc centers)	<ul style="list-style-type: none"> • center of each arc • radius of each arc
19	Center and points of intersection of an arc tangent to two arcs	<ul style="list-style-type: none"> • 2 of the arc centers • all 3 radii
20	Center of an arc	<ul style="list-style-type: none"> • 2 points on the arc • radius of the arc
22	Radius of an arc or circle	<ul style="list-style-type: none"> • 1 point on the arc • center of the arc
23	Center of an arc or circle	<ul style="list-style-type: none"> • 2 points on the arc • angle between the 2 points
24	Center and radius of an arc or circle	<ul style="list-style-type: none"> • 3 different points on the arc
25	Cartesian (X and Y) location	<ul style="list-style-type: none"> • polar (R and angle) coordinates
26	Angle in decimal	<ul style="list-style-type: none"> • angle degrees, minutes and seconds
27	Accurate X Y Center	<ul style="list-style-type: none"> • given X Y Center • 2 points on the arc
28	Sides and angles of a right triangle	<ul style="list-style-type: none"> • at least one side and another side or an angle
Calculator	+, -, *, /, =, square root	

14.0 Service Codes

Service codes are special codes used for set-up, installation, program file transfer and service.

For Service Codes press MODE, SET-UP and SERVICE CODES.

Press A for Software Codes. Input the code number and press SET.

Code	Description	Comment
33	Software, Firmware and PLC versions	Displays current software versions and system settings.
141	Load configuration file from USB thumb drive	To load configuration files from a USB thumb drive to the KMX control.
142	Save configuration file to USB thumb drive	To save the configuration files for reloading later. When a computer replacement is necessary, saving the settings to a thumb drive for reloading them later is highly desirable.
316	Update Software	Runs the routine that copies new software from a USB thumb drive device to the ProtoTRAK system. Use this routine to install new ProtoTRAK software.

Press B for Machine Codes. Input code number and press SET.

11	Hysterisis	Measures the backlash between motor encoders and glass scales.
12	Feed Forward Constant	Measures the friction characteristic of the machine.
97	Axis Configuration	It allows the user to set the positive direction for each axis.
122	Axis Calibration Using Offset	This is a scale factor (one per axis) that is defined as the length of the part programmed divided by the physical dimension of the actual part measured. It is less than 1 for a part that was cut too big and greater than 1 for a part that was cut too small.
123	Calibration Mode	Use to calibrate the KMX control with a standard
128	Backlash Calibration Constant	Use to load backlash compensation for each axis.
304	Toggle X Sensor/Glass Scale On or Off	Turn on or off
305	Toggle Y Sensor/Glass Scale On or Off	Turn on or off
308	Reverse X EHW Direction	Change direction of EHW on X axis
309	Reverse Y EHW Direction	Change direction of EHW on Y axis
312	Toggle Limit Switches On or Off	Turns limit switches on or off
321	Reverse Y Position Sensor	Reverse the direction of the sensor or glass scale
322	Reverse X Position Sensor	Reverse the direction of the sensor or glass scale
325	Reverse Quill Position Sensor	Reverse the quill sensor or glass scale. Service code 97 should do the same.
338	Toggle Limit Switches from 1 to 2 input	Tells software which style limit switch is present.
350	Turn EHW On or Off	Turns the EHW option on or off since EHW are optional.

400	Update Foreign Language MLS File	Allows user to either update the MLS language files, or to select from a list of pre-installed languages.
-----	----------------------------------	---

Press C for Diagnostic Codes. Input code number and press SET.

1	Program, Configuration File, Log Back up	The following service code captures all important data from the 2 OP machine. This includes the users program, configuration files, message log, fault log etc. This is meant to be used to help us solve problems that may pertain to our software. This file can then be emailed to our service department.
54	Continuous Run Mode	Cycles through the program in current memory.
81	Program Panel Keyboard Test	Gives a tone feedback to a button push and highlights the button.
100	Open Loop Test	Run an axis at rapid speed for 1 second to check encoders
131	Manual DRO	Turns off servos so you can check encoders
132	Electronic Handwheel Test	Test the EHW signals
319	Message Log	Logs the machine as it runs. It captures all key presses, error messages and data as the machine runs. It is saved automatically with service code 1.
320	Fault Log	A log that captures all faults and error messages.
326	Error Message Display	Displays error messages on screen
327	Display Memory Check	Displays memory availability of various devices
342	Test Light Indicator	Turns on and off some test lights used for troubleshooting blocks per second problems.
521	Check Control IO (input/output)	Application used to check all machine input and outputs.

Press D for Operator Defaults/Options Codes. Input code number and press SET.

66	Metric Boot Up Default	To have the ProtoTRAK open up in mm measurement.
67	English Boot Up Default	To have the ProtoTRAK open up in inch measurement.
79	Turn On Beeper	Turn the beeper on when pressing keys on either of the front panels
80	Turn Off Beeper	Turns the beeper off when pressing keys
140	Step Over for Pockets and Face Mill	Allows user to set step over distances
345	Set Part Program Location	Sets the location of part program storage between a USB device and to a network

For other codes and more explanation for these, please see ProtoTRAK KMX Safety, Installation, Maintenance, Service and Part List Manual; part number 29777 or 29780.

TRAK Warranty Policy

Warranty

TRAK products are warranted to the original purchaser to be free from defects in workmanship and materials for the following periods:

Product	Warranty Period	
	Materials	Factory Labor
New TRAK/ProtoTRAK	1 Year	1 Year
Any EXCHANGE Unit	90 Days	90 Days

The warranty period starts on the date of the invoice to the original purchaser from Southwestern Industries, Inc. (SWI) or their authorized distributor.

If a product, subsystem or component proves to be defective in workmanship and fails within the warranty period, it will be repaired or exchanged at our option for a properly functioning unit in similar or better condition. Such repairs or exchanges will be made FOB Factory/Los Angeles or the location of our nearest factory representative or authorized distributor.

Warranty Disclaimers

- This warranty is expressly in lieu of any other warranties, express or implied, including any implied warranty of merchantability or fitness for a particular purpose, and of any other obligations or liability on the part of SWI (or any producing entity, if different).
- Warranty repairs/exchanges do not cover incidental costs such as installation, labor, freight, etc.
- SWI is not responsible for consequential damages from use or misuse of any of its products.
- TRAK products are precision mechanical/electromechanical/electronic systems and must be given the reasonable care that these types of products require. Evidence that the product does not receive adequate Preventative Maintenance may invalidate the warranty. Excessive chips built up around ballscrews and way surfaces is an example of this evidence.
- Accidental damage, beyond the control of SWI, is not covered by the warranty. Thus, the warranty does not apply if a product has been abused, dropped, hit or disassembled.
- Improper installation by or at the direction of the customer in such a way that the product consequently fails, is considered to be beyond the control of the manufacturer and outside the scope of the warranty.
- Warranty does not cover wear items that are consumed under normal use of the product. These items include, but are not limited to: windows, bellows, wipers, filters, drawbars and belts.