

TRAK® TMC ProtoTRAK® RMX CNC

Safety, Installation, Maintenance, Service and Parts List

Document:	P/N 31551
Version:	100324

Covers Current Models:

- TRAK TMC5
- TRAK TMC7
- TRAK TMC10
- TRAK TMC12
- TRAK TMC14

Covers Previously Branded Models:

- TRAK VMC5
- TRAK VMC7
- TRAK VMC10

TRAK MACHINE
TOOLS



SOUTHWESTERN INDUSTRIES, INC.

2615 Homestead Place

Rancho Dominguez, CA 90220-5610 USA

T | 310.608.4422 | F | 310.764.2668

Service Department: 800.367.3165

e-mail: sales@trakmt.com | service@trakmt.com | web: www.trakmt.com

Copyright © 2021, Southwestern Industries, Inc. All rights are reserved. No part of this publication may be reproduced, stored in a retrieval system, or transmitted, in any form or by any means, mechanical, photocopying, recording or otherwise, without the prior written permission of Southwestern Industries, Inc.

While every effort has been made to include all the information required for the purposes of this guide, Southwestern Industries, Inc. assumes no responsibility for inaccuracies or omission and accepts no liability for damages resulting from the use of the information contained in this guide.

All brand names and products are trademarks or registered trademarks of their respective holders.

TRAK Machine Tools

Southwestern Industries, Inc.

2615 Homestead Place

Rancho Dominguez, CA 90220-5610

Phone 310.608.4422 • Fax 310.764.2668

Service Department

Phone 800.367.3165 • Fax 310.886.8029

Web: www.trakmt.com

Table of Contents

1.0	Safety	1
1.1	Safety Publications	1
1.2	Danger, Warning, Caution, Note Labels & Notices as Used in This Manual	1
1.3	Tool Room Op and Production Op	7
1.4	Safety Precautions.....	8
2.0	Installation of TRAK TMC Series Machining Centers	10
2.1	Installation Requirements	10
2.2	Overall Dimensions.....	11
2.3	Cleaning the TMC.....	16
2.4	Lifting and/or Placing the TMC	17
2.4.1	Lifting the TMC Using a Crane	18
2.5	Uncrating the TMC	19
2.5.1	Releasing the Head Support Bracket	22
2.6	Leveling Procedure	22
2.6.1	Leveling Pad Specifications.....	22
2.6.2	Leveling Procedure	24
2.6.3	Adjusting Level for Tram	25
2.7	Shortages: Inventory Checklist.....	26
2.8	Electrical Connection	27
2.8.1	Main Power to the Machine Connections	28
2.8.2	Transformer Option	28
2.9	Air Connection	29
2.9.1	Air Regulators and Solenoids	29
2.10	Placing the Coolant System	31
2.11	Installation Checklist.....	32
2.12	Lubrication.....	37
2.12.1	Way Lubrication	37
2.12.2	Other TMC Lubrication Points.....	38
2.13	Machine Specifications.....	39
2.13.1	Maximum Spindle Torque & HP.....	44
2.14	ProtoTRAK RMX Euclid Block Procedure	46
3.0	Troubleshooting by Symptom	48
3.1	Problems Relating to Machining Results	48
3.1.1	Poor Finish	48

3.1.2	Circles Out of Round	49
3.1.3	Parts Have Incorrect Dimensions	49
3.2	Motion Related Problems	50
3.2.1	Run Away Axis.....	50
3.2.2	Axis Will Not Jog with Electronic Handwheel	50
3.2.3	Searching Axis.....	51
3.2.4	Homing Error – Axis, Tool Changer	51
3.3	Computer Related Issues	52
3.3.1	USB Not Working on Pendant Enclosure	52
3.3.2	Programming Panel Does Not Power On.....	53
3.3.3	Blank Display.....	54
3.3.4	White Display	55
3.3.5	System Will Not Boot	55
3.3.6	E-Stop Error	56
3.3.7	Overlay Keys Not Responding.....	57
4.0	Automatic Tool Changer Operation and Service Codes.....	59
4.1	Tool Changer Operation.....	59
4.2	Spindle Orientation.....	59
4.3	Tool Change Height.....	59
4.4	Tool Changer Sensors.....	60
4.4.1	ATC Home Position Sensor	60
4.4.2	ATC Counter Sensor.....	61
4.4.3	ATC Tool Detect Sensor	61
4.4.4	ATC “In”	63
4.4.5	ATC “Out”	63
4.4.6	Tool “Unclamp”	63
4.4.7	Tool “Clamp”	63
4.5	ATC Flow Control Valves	63
4.6	Error Messages Relating to the ATC.....	64
4.7	Diagnostics Table	65
4.8	Service Codes	66
4.8.1	Section A - Software Code Details.....	68
4.8.2	Section B - Machine Set-Up Code Details.....	69
4.8.3	Section C - Diagnostic Code Details.....	71
4.8.4	Section D - Operator Defaults/Options Codes Details	72

4.9	Critical Service Codes that Must Be Performed	73
5.0	Procedure for Replacements & Maintenance	74
5.1	Replacements	74
5.1.1	Servo Drive Replacement	74
5.1.2	Programming Panel, Run Panel and Computer Module Replacement	74
5.1.3	Updating the Pendant and CM Software	78
5.1.4	Adding Solid State Drive (SSD) Memory Option	78
5.1.5	Cable Routing on Machine	81
5.1.6	Electronic Handwheel Option	82
5.1.7	Electronic Handwheel and Sensor Replacement	84
5.1.8	Auger Motor, Coolant and Coolant Wash Down Pump Replacements	86
5.1.9	Servomotor Replacement	88
5.2	Maintenance	93
5.2.1	How to Clean the Touchscreen	93
5.2.2	Periodic Maintenance	93
5.3	Laser Calibration	93
5.3.1	Accuracy	93
5.3.2	Code 123: Calibration	94
5.3.3	Calibration Table	95
6.0	4th Axis Option	96
6.1	4 th Axis Specifications	96
6.2	Mounting the 4 th Axis	97
6.3	Installation Checklist of the 4 th Axis	100
6.4	Service Codes: 4 th Axis	101
6.4.1	Code 318: Turn on 4 th Axis Option	101
6.4.2	Code 128: Input Backlash Constant	101
6.4.3	Code 502: Set Base Tool Offset	101
6.4.4	Code 505: A Axis Motor Index	102
6.4.5	Code 506: Set 4 th Axis Offsets	102
6.5	Troubleshooting by Symptom	102
6.6	Servomotor Replacement Procedures	104
6.6.1	Servomotor Replacement Service Codes	105
6.6.2	Chuck and Adapter Plate Removal and Replacement	105
7.0	Coolant Through Spindle (CTS) Option	106
7.1	CTS Sensors and Filter Location	107

7.2	CTS Filter Clog Sensor Operation.....	107
7.3	CTS Filter Element Replacement.....	108
7.4	CTS Filter Clog Sensor Replacement	108
7.5	CTS Coolant Pressure Sensor	109
7.6	CTS Coolant Pressure Sensor Replacement and Calibration	109
7.7	CTS Remove and Replace Pump.....	110
8.0	12K Spindle Option	111
8.1	12K Spindle Operation	111
8.2	Added Spindle Oil Circulation With 12K Option	112
8.3	12K Spindle Maximum Spindle Torque & HP.....	113
8.4	12K Maintenance and Adding Oil	114
8.4.1	Oil Type and System Maintenance Intervals	115
8.5	Spindle Warm Up Procedure	116
8.6	12K Warning Message	116
8.7	Installation Checklist of 12K with CTS.....	117
9.0	Probe Part Option	122
9.1	Service Codes: Probe Part.....	124
9.1.1	Code 124: Probe Part calibration	124
9.2	Probe Calibration Procedure.....	124
10.0	Introduction to Self-Service	127
10.1	When You Have a Service Problem.....	127
10.1.1	Communication with the SWI Customer Service Group.....	127
10.2	Replacements	127
10.2.1	Exchange Program.....	127
10.2.2	Return Material Authorization (RMA) Number.....	128
11.0	Appendix – Drawings.....	129
11.1	Drawing 31530 – 4 th Axis Assembly	129
11.2	Drawing 31538 – 4 th Axis Option	132
	TRAK Warranty Policy.....	137

1.0 Safety

The safe operation of the TRAK TMC depends on its proper use and the precautions taken by each operator.

- Read and study this manual and the ProtoTRAK TMC/VMC2 Programming, Operating, and Care Manual. Be certain every operator understands the operation and safety requirements of this machine before its use.
- Never run the machine with enclosure doors open when in production ops.
- Always wear safety glasses and safety shoes.
- Always stop the spindle and check to ensure the CNC control is in the stop mode before changing or adjusting the tool or workpiece.
- Never wear gloves, rings, watches, long sleeves, neckties, jewelry, or other loose items when operating or around the machine.
- Use adequate point of operation safeguarding. It is the responsibility of the employer to provide and ensure point of operation safeguarding per OSHA 1910.212 - Milling Machine.

1.1 Safety Publications

Refer to and study the following publications for assistance in enhancing the safe use of this machine. **Safety Requirements for Machining Centers and Automatic, Numerically Controlled Milling, Drilling and Boring Machines** (ANSI B11.23-2002) (R2007). Available from The American National Standards Institute, 1819 L Street N.W., Washington D.C. 20036

Concepts and Techniques of Machine Safeguarding (OSHA Publication Number 3067). Available from The Publication Office - O.S.H.A., U.S. Department of Labor, 200 Constitution Avenue, NW, Washington, DC 0210.

1.2 Danger, Warning, Caution, Note Labels & Notices as Used in This Manual

DANGER - Immediate hazards that **will** result in severe personal injury or death. Danger labels on the machine are red in color.

WARNING - Hazards or unsafe practices which *could* result in severe personal injury and/or damage to the equipment. Warning labels on the machine are orange in color.

CAUTION - Hazards or unsafe practices, which *could* result in minor personal injury or equipment/product damage. Caution labels on the machine are yellow in color.

NOTE - Call attention to specific issues requiring special attention or understanding.

Safety & Information Labels Used on The TRAK Milling Machines
It is forbidden by OSHA regulations and by law to deface, destroy or remove any of these labels



i01434

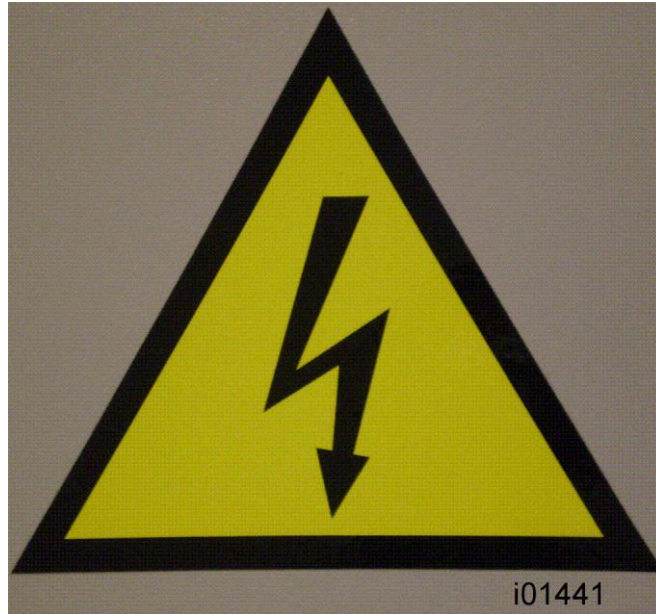

i01441



i01437

Safety & Information Labels Used on The TRAK Milling Machines



i01438

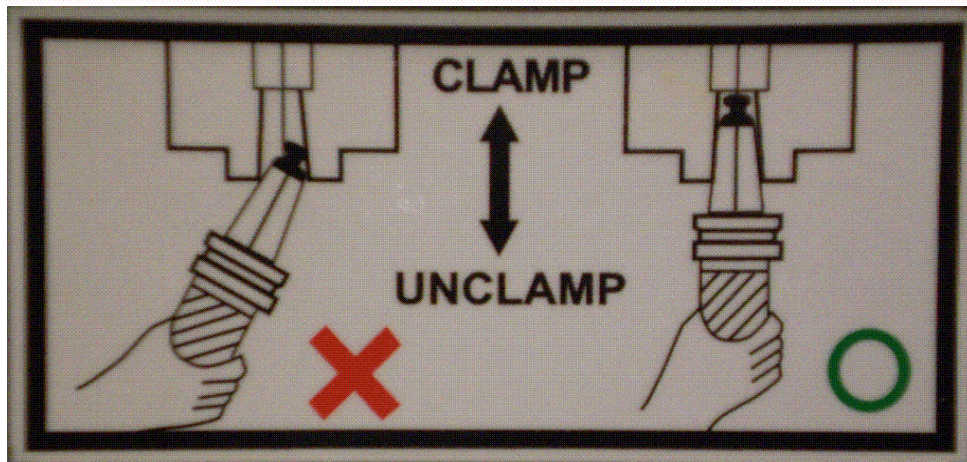

i01435



i01439

Safety & Information Labels Used on The TRAK Milling Machines

Air pressure setting	
Max.pressure setting	115psi / 8kg/cm ²
Min.pressure setting	70psi / 5kg/cm ²
Pressure sensor setting	60psi / 4 kg/cm ²

i01436

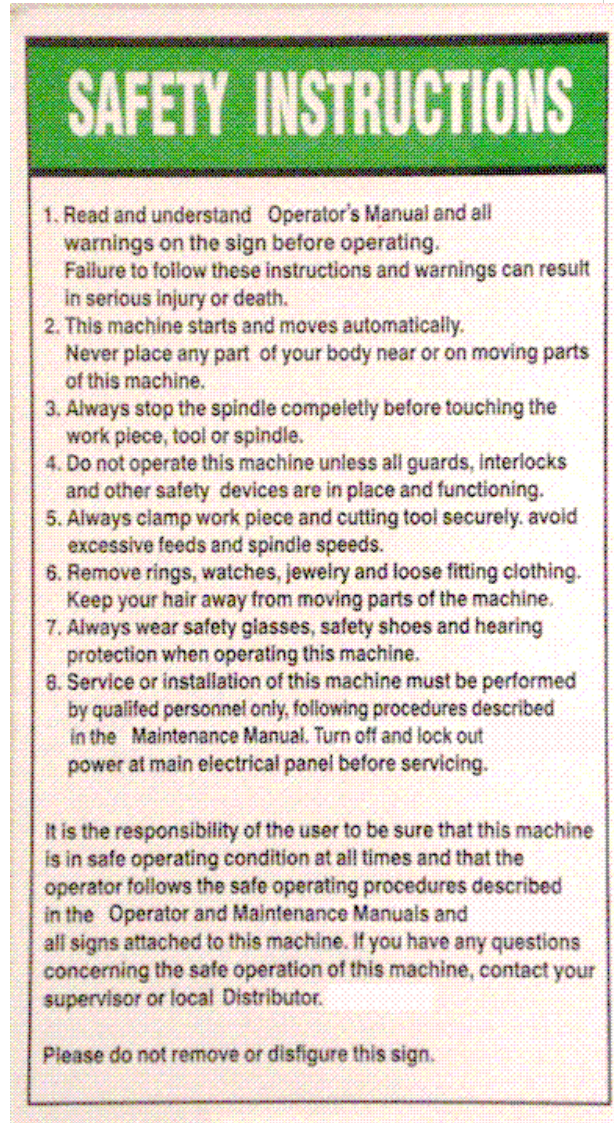

SAFETY INSTRUCTIONS

1. Read and understand Operator's Manual and all warnings on the sign before operating.
Failure to follow these instructions and warnings can result in serious injury or death.
2. This machine starts and moves automatically.
Never place any part of your body near or on moving parts of this machine.
3. Always stop the spindle completely before touching the work piece, tool or spindle.
4. Do not operate this machine unless all guards, interlocks and other safety devices are in place and functioning.
5. Always clamp work piece and cutting tool securely, avoid excessive feeds and spindle speeds.
6. Remove rings, watches, jewelry and loose fitting clothing.
Keep your hair away from moving parts of the machine.
7. Always wear safety glasses, safety shoes and hearing protection when operating this machine.
8. Service or installation of this machine must be performed by qualified personnel only, following procedures described in the Maintenance Manual. Turn off and lock out power at main electrical panel before servicing.

It is the responsibility of the user to be sure that this machine is in safe operating condition at all times and that the operator follows the safe operating procedures described in the Operator and Maintenance Manuals and all signs attached to this machine. If you have any questions concerning the safe operation of this machine, contact your supervisor or local Distributor.

Please do not remove or disfigure this sign.

i01440

Safety & Information Labels Used on The TRAK Milling Machines



i22774



Safety & Information Labels Used on The TRAK Milling Machines

It is forbidden by OSHA regulations and by law to deface, destroy or remove any of these labels

TRAK MACHINE TOOLS

 SOUTHWESTERN INDUSTRIES, INC.
2615 HOMESTEAD PLACE,
RANCHO DOMINGUEZ, CA 90220

MODEL

S/N

THIS UNIT HAS _____ POWER SOURCE(S)
ELECTRICAL RATINGS:

VOLTS AMPS PHASE
 Hz

VOLTS AMPS PHASE
 Hz

FLA OF LARGEST MOTOR AMPS
SHORT CIRCUIT CURRENT RATING AMPS

ELECTRICAL DRAWING #:

MACHINE (ONLY) MADE IN TAIWAN

1.3 Tool Room Op and Production Op

TRAK's TMC's are designed to be switchable between tool room operation and production operation. Each operation changes several parameters and methods of use to optimize the machine for each operation.

Specifically:

Production Operation

- 1,000 ipm rapid
- 8,000 maximum rpm
- Interlocked door
- ATC (Automatic Tool Changer) operation
- Auto spindle start after tool change
- Full 3 - Axis operation

Tool Room Operation

- 400 ipm rapid
- 5,000 maximum rpm
- Programs run with door open or closed
- No ATC operation
- Manual Spindle by operator
- Allows manual, 2 – axis and 3 – axis operation

Figure 1.3 shows the TMC Console Programming Panel and Run Panel. Also shown are the key lock switch to select Tool Room or Production Operation and a display of the current Operation selected.

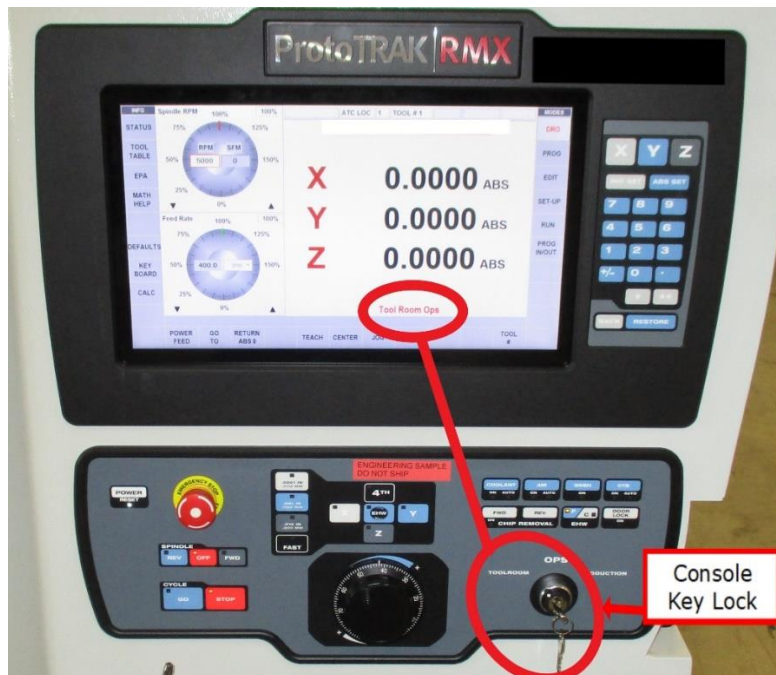

Figure 1.3 - TMC Programming Panel and Run Panel

1.4 Safety Precautions

1. Do not operate this machine before the TRAK TMC Installation, Maintenance, Service and Parts List Manual, and ProtoTRAK TMC Programming, Operating & Care Manual have been studied and understood.
2. Do not run this machine without knowing the function of every control key, button, knob, or handle. Ask your supervisor or a qualified instructor for help when needed.
3. Protect your eyes. Wear approved safety glasses (with side shields) at all times.
4. Don't get caught in moving parts. Before operating this machine remove all jewelry including watches and rings, neckties, and any loose-fitting clothing.
5. Keep your hair away from moving parts. Wear adequate safety headgear.
6. Protect your feet. Wear safety shoes with oil-resistant, anti-skid soles, and steel toes.
7. Take off gloves before you start the machine. Gloves are easily caught in moving parts.
8. Remove all tools (wrenches, chuck keys, etc.) from the machine before you start. Loose items can become dangerous flying projectiles.
9. Never operate a milling machine after consuming alcoholic beverages, or taking strong medication, or while using non-prescription drugs.
10. Protect your hands. Stop the machine spindle and ensure that the CNC control is in the stop mode:
 - Before changing tools
 - Before changing parts
 - Before you clear away the chips, oil or coolant. Always use a chip scraper or brush
 - Before you make an adjustment to the part, fixture, coolant nozzle or take measurements
 - Before you open safeguards (protective shields, etc.). Never reach for the part, tool, or fixture around a safeguard.
11. Protect your eyes and the machine as well. Don't use compressed air to remove the chips or clean the machine.
12. Disconnect power to the machine before you change belts, pulley, and gears.
13. Keep work areas well lighted. Ask for additional light if needed.
14. Do not lean on the machine while it is running.
15. Prevent slippage. Keep the work area dry and clean. Remove the chips, oil, coolant and obstacles of any kind around the machine.
16. Avoid getting pinched in places where the table, saddle, tool changer or spindle head create "pinch points" while in motion.
17. Securely clamp and properly locate the workpiece in the vise, on the table, or in the fixture. Use stop blocks to prevent objects from flying loose. Use proper holding clamping attachments and position them clear of the tool path.
18. Use correct cutting parameters (speed, feed, depth, and width of cut) in order to prevent tool breakage.
19. Use proper cutting tools for the job. Pay attention to the rotation of the spindle: Left hand tool for counterclockwise rotation of spindle, and right-hand tool for clockwise rotation of spindle.

20. After an emergency stop, release the E-stop and press the power reset button for 2 seconds to turn the servos back on.
21. Prevent damage to the workpiece or the cutting tool. Never start the machine (including the rotation of the spindle) if the tool is in contact with the part.
22. Check the direction (+ or -) of movement of the table, saddle, and quill when using the jog or power feed or ram out.
23. Don't use dull or damaged cutting tools. They break easily and become airborne. Inspect the sharpness of the edges, and the integrity of cutting tools and their holders. Use proper length tool for the job.
24. Large overhang on cutting tools when not required result in accidents and damaged parts.
25. Inspect the retention knobs for damage or excessive wear before each use.
26. Prevent fires. When machining certain materials (magnesium, etc.) the chips and dust are highly flammable. Obtain special instruction from you supervisor before machining these materials. Keep flammable materials and fluids away from the machine and hot, flying chips.
27. Always be certain that you know if the machine is in Production or Tool Room Operation (See Section 1.3).
28. Always be certain the door is closed during Run Mode when the machine is in Production Operation.

2.0 Installation of TRAK TMC Series Machining Centers

IMPORTANT: Read and understand this entire installation section before beginning the TMC installation.

2.1 Installation Requirements

Before an Authorized Field Service Technician can perform the machine's final checkout, detailed requirements must be met. Please refer to the Site Preparation Guide for the needed set up for your specific TMC model.

2.2 Overall Dimensions

TMC 5

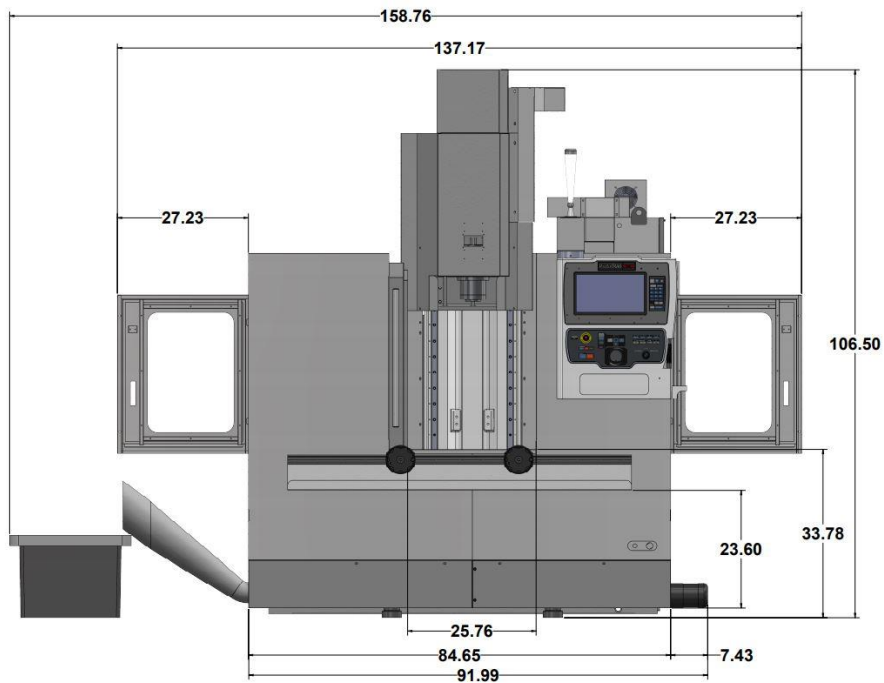

TMC 5 Front View

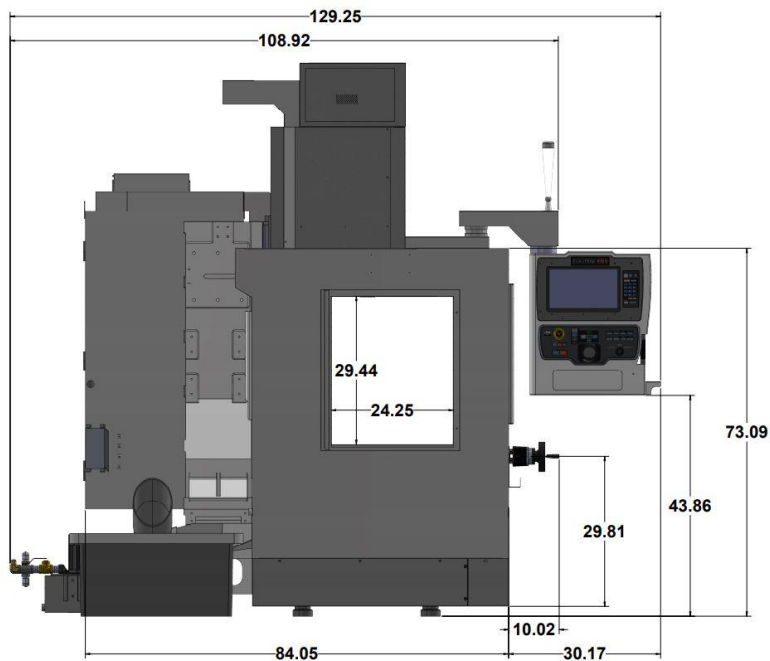

TMC 5 Left Side View

TMC 7

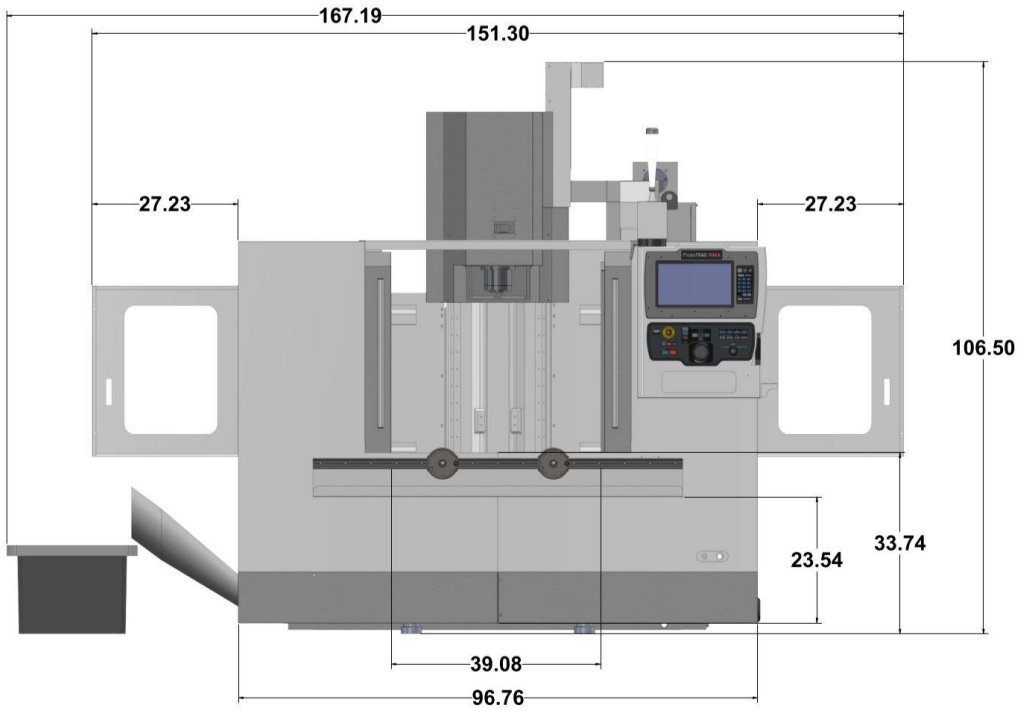

TMC 7 Front View

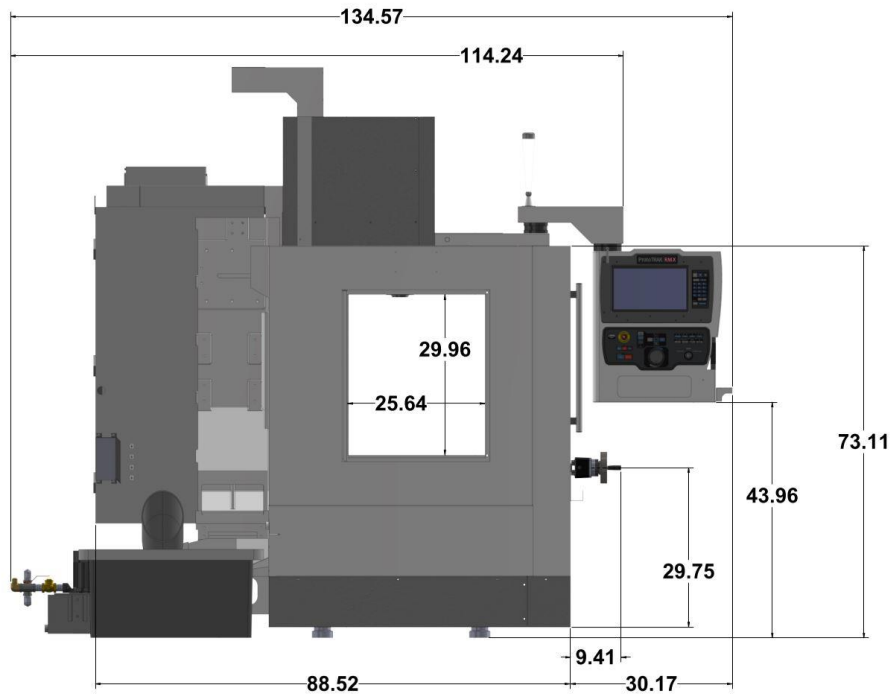

TMC 7 Left Side View

TMC 10

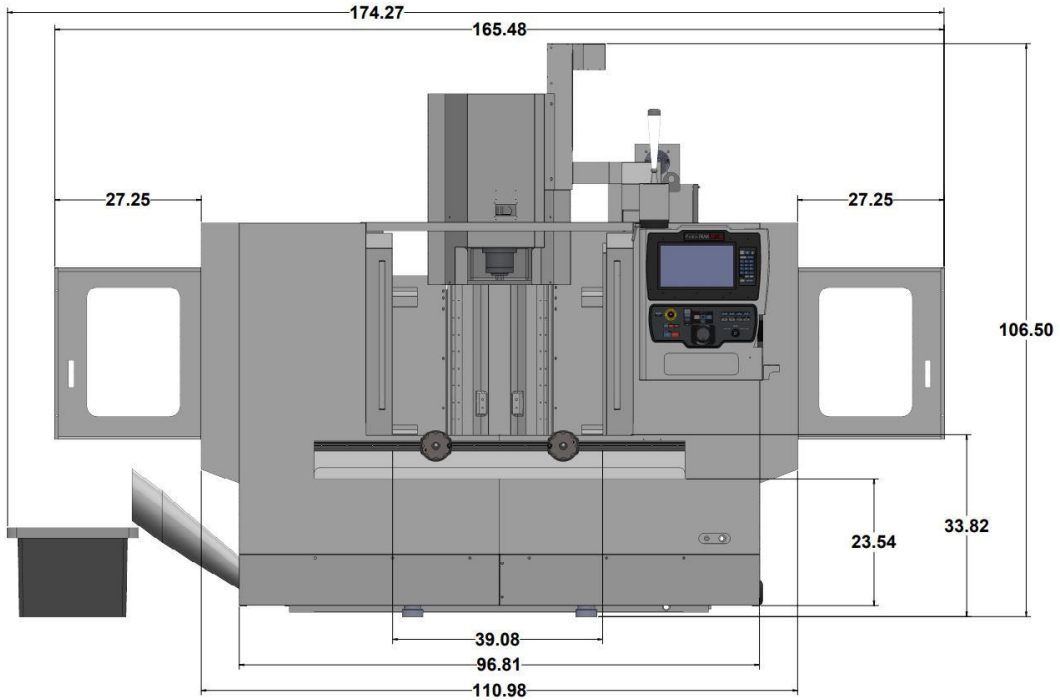

TMC 10 Front View

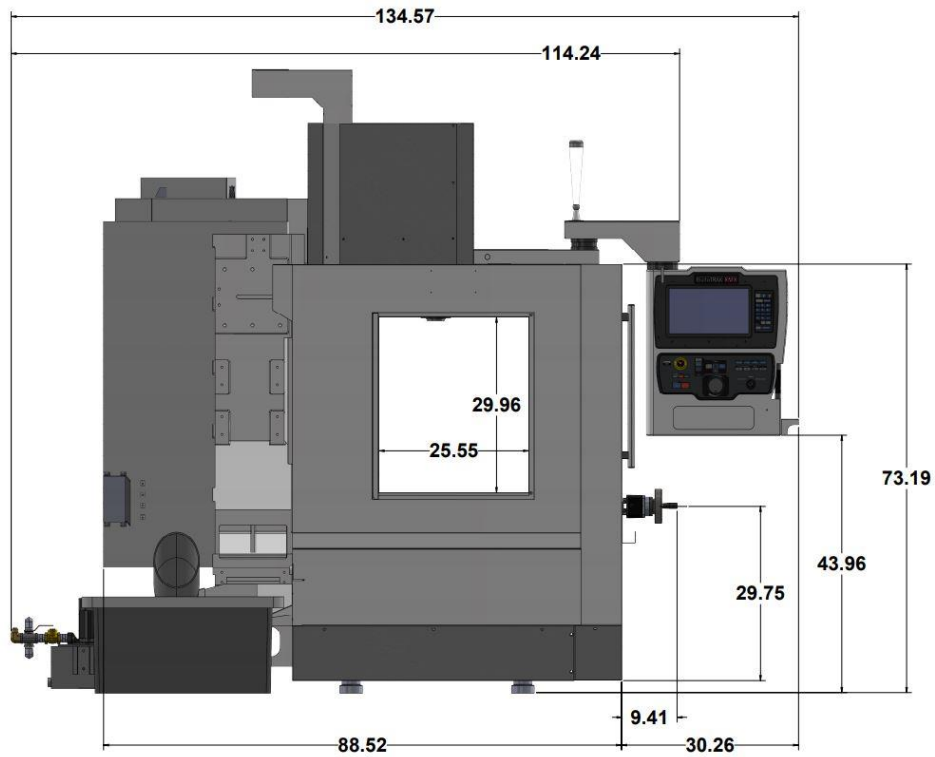

TMC 10 Left Side View

TMC 12

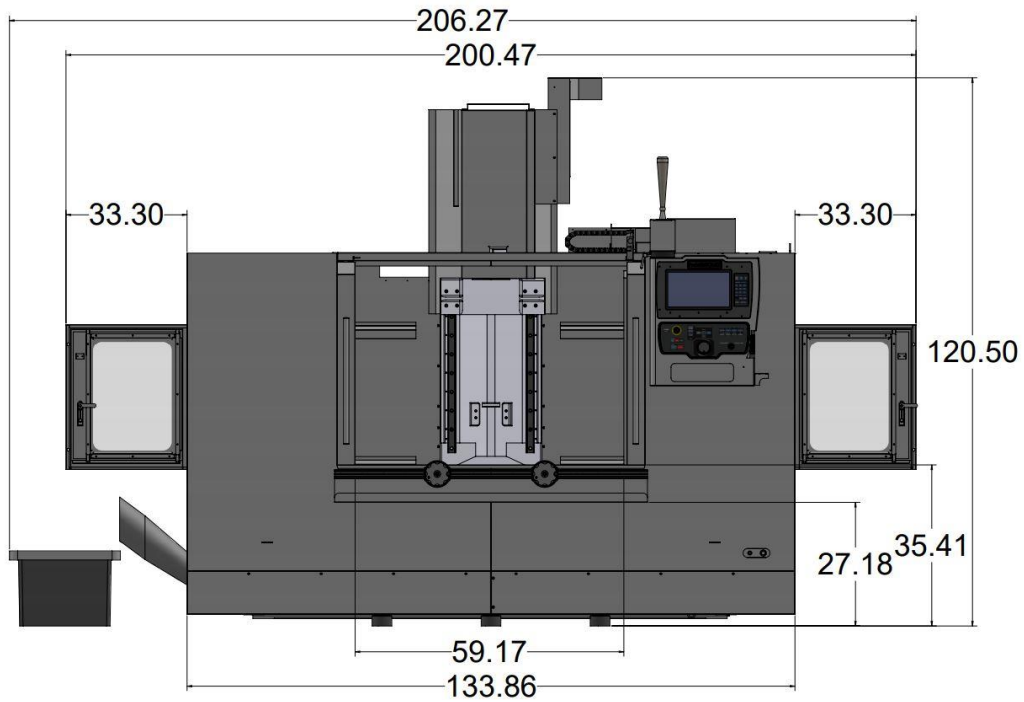

TMC 12 Front View

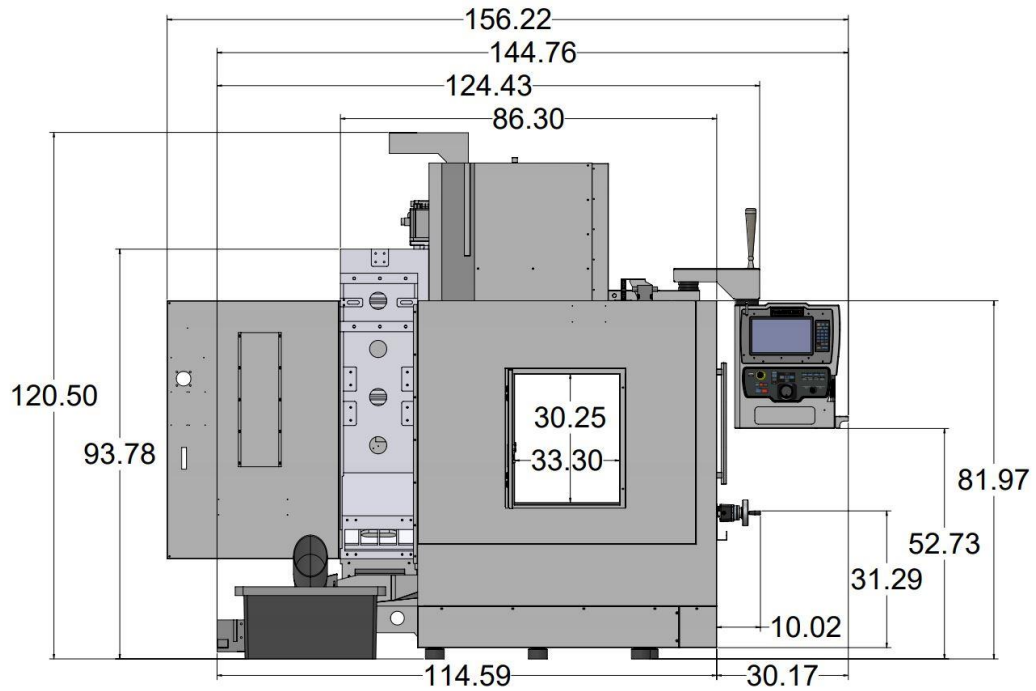

TMC 12 Left Side View

TMC 14

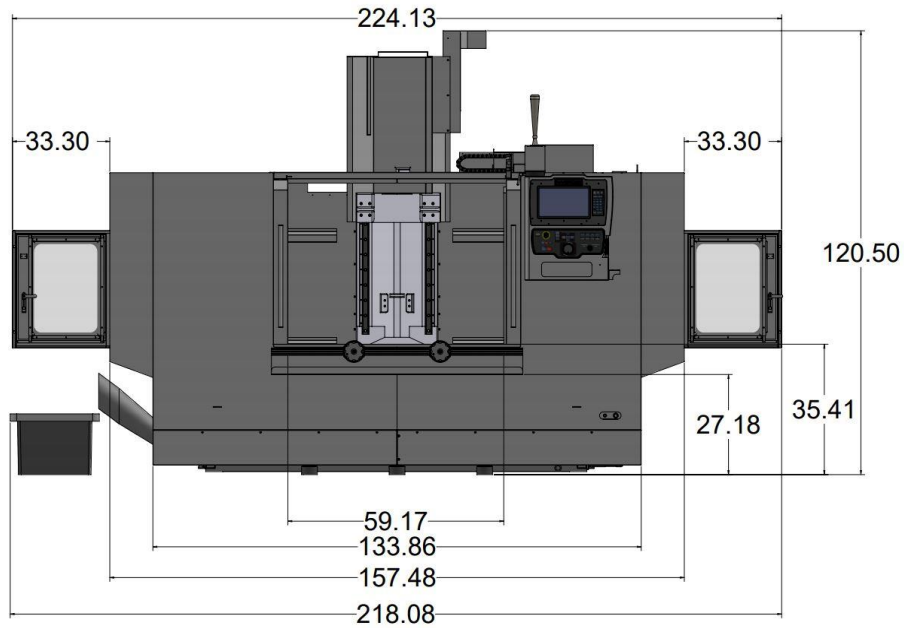

TMC 14 Front View

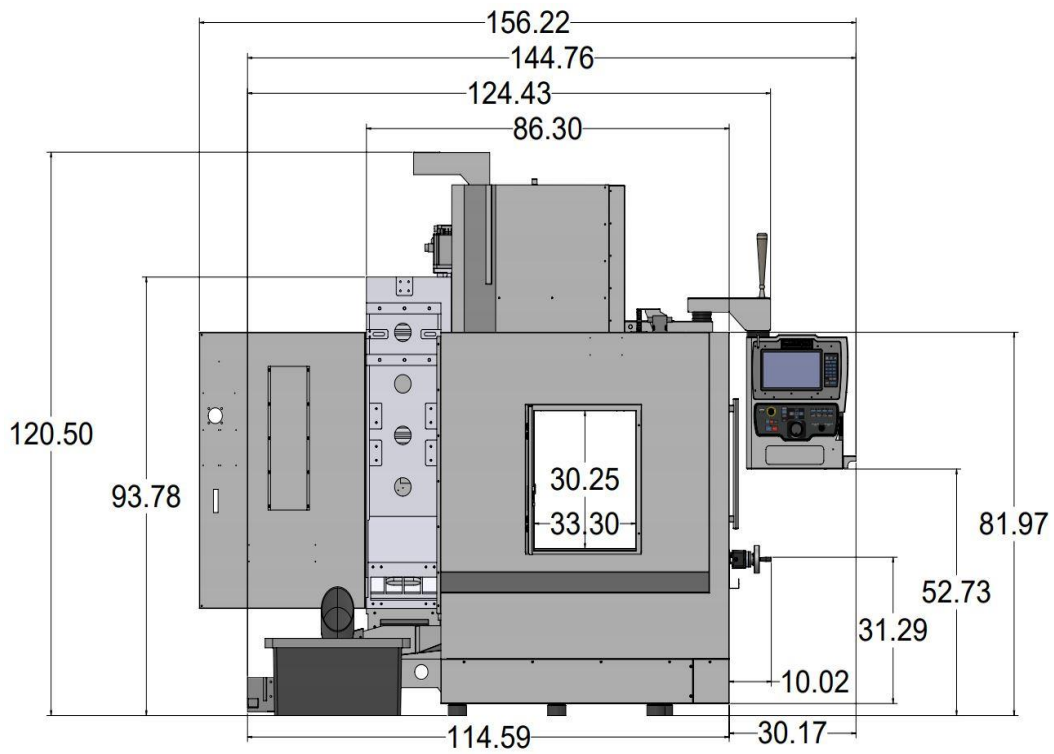

TMC 14 Left Side View

2.3 Cleaning the TMC

1. Remove all the cardboard and protective plastic sheeting from the machine.
2. With a soft cloth, remove all the protective oil from the machine. DO NOT USE ANY SHARP OBJECTS ON THE LINEAR GUIDEWAYS OR THE BALL SCREW. USE ONLY LINT FREE CLOTH IN THESE AREAS. It may be necessary to move the table, saddle and head left and right, up and down when cleaning.
3. Clean the way covers as they come shipped with a rust prevention spray on them. WD-40 works well to remove this agent.
4. When cleaning the windows, use a suitable cleaner that DOES NOT contain ammonia or solvents that could damage the polycarbonate windows.

WARNING!

Do not use water-based cleaning agents for cleaning the machine.

ATTENTION!

Immediately report, in writing, any damages observed at this time that can be attributed to the transportation or improper handling/moving of the machine.

2.4 Lifting and/or Placing the TMC

The TMC must be lifted and/or moved with a forklift with a minimum capacity of 15,000 lbs. from the rear of the machine or from either side. Make certain that the blades of the forklift are completely through the casting cutouts beneath the machine before lifting as shown in Figures 2.4a & 2.4b.



Figure 2.4a - Fork Lift with TMC Cargo



Figure 2.4b - Detail of Fork lift blades set in TMC base and proper set up of Leveling Pads

2.4.1 Lifting the TMC Using a Crane

If you would like to lift the machine with a crane, the following figures show the lifting points.

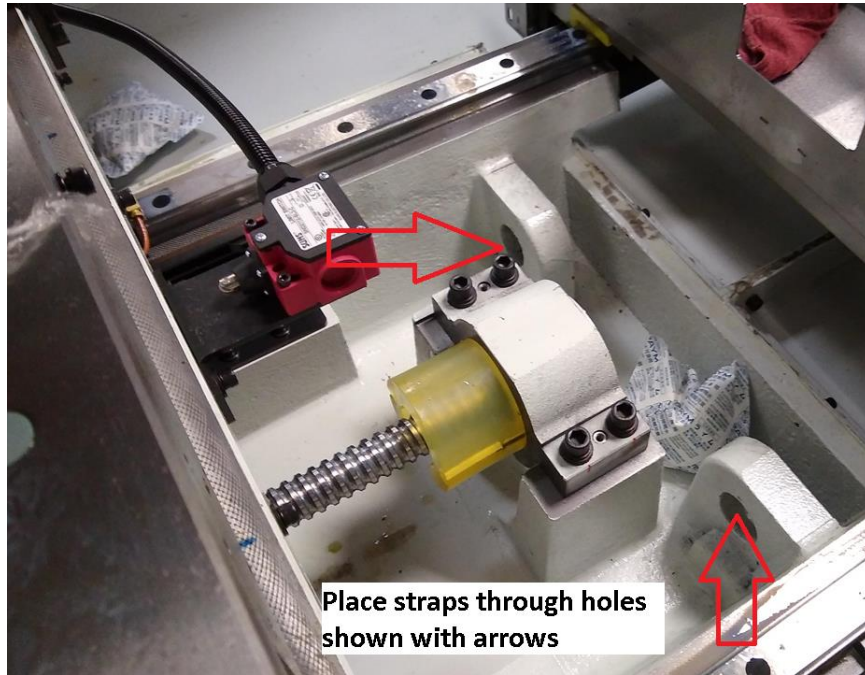

Figure 2.4.1a Lifting the Machine with Straps

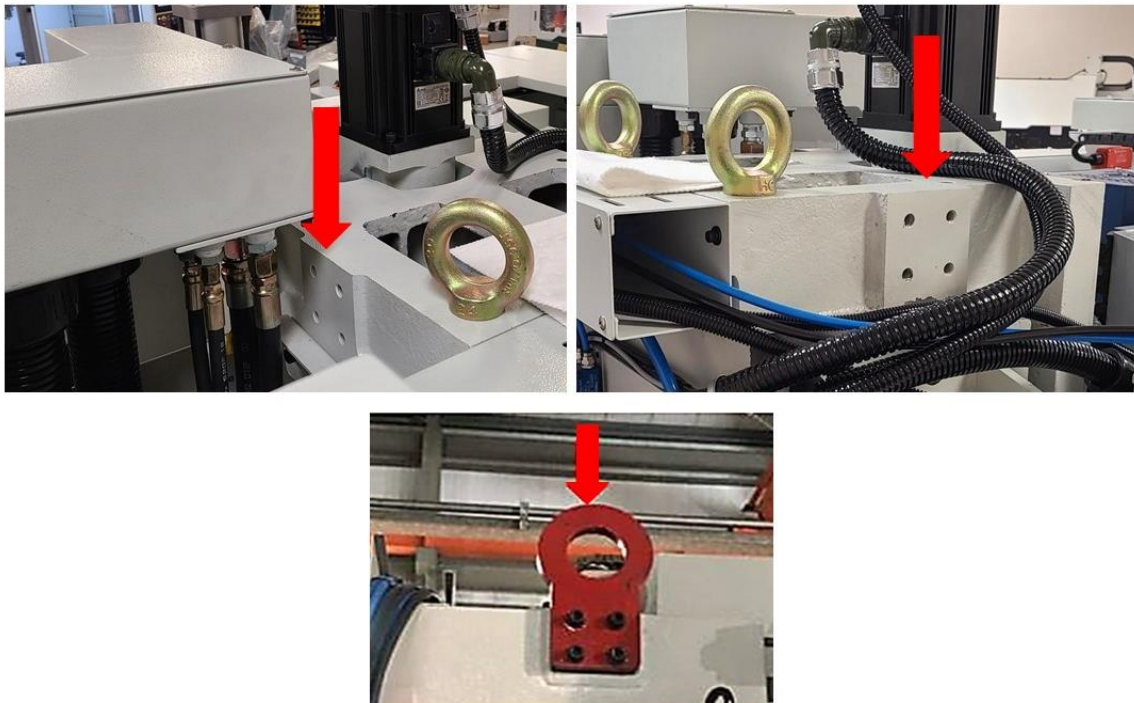

Figure 2.4.1b - Lifting the Machine on Top of Column

2.5 Uncrating the TMC

1. Remove the loose articles from the pallet and check them against the loose Inventory Checklist (Section 2.7).
2. The tool measurement cart kit and the tooling pre-setter will require some assembly. Instructions to assemble will be found in the kit. (Optional Equipment)
3. Remove the 5 M6x15 SHCS that secure the saddle and table support brackets, and remove the brackets (See figure 2.5.a)
4. Remove the 4 M12x40 SHCS that secure the column support bracket from the table and the head, but **DO NOT ATTEMPT TO REMOVE THE SUPPORT AT THIS TIME.** (See figure 2.5.b)
5. Remove the ATC cover, left. Remove the M8x60 SHCS that secures the ATC during shipping (See figure 2.5.c).
6. Remove the 4 (left door) + 4 (right door) M6x16 SHCS that secures the front doors (see Figure 2.5.d & 2.5.e).

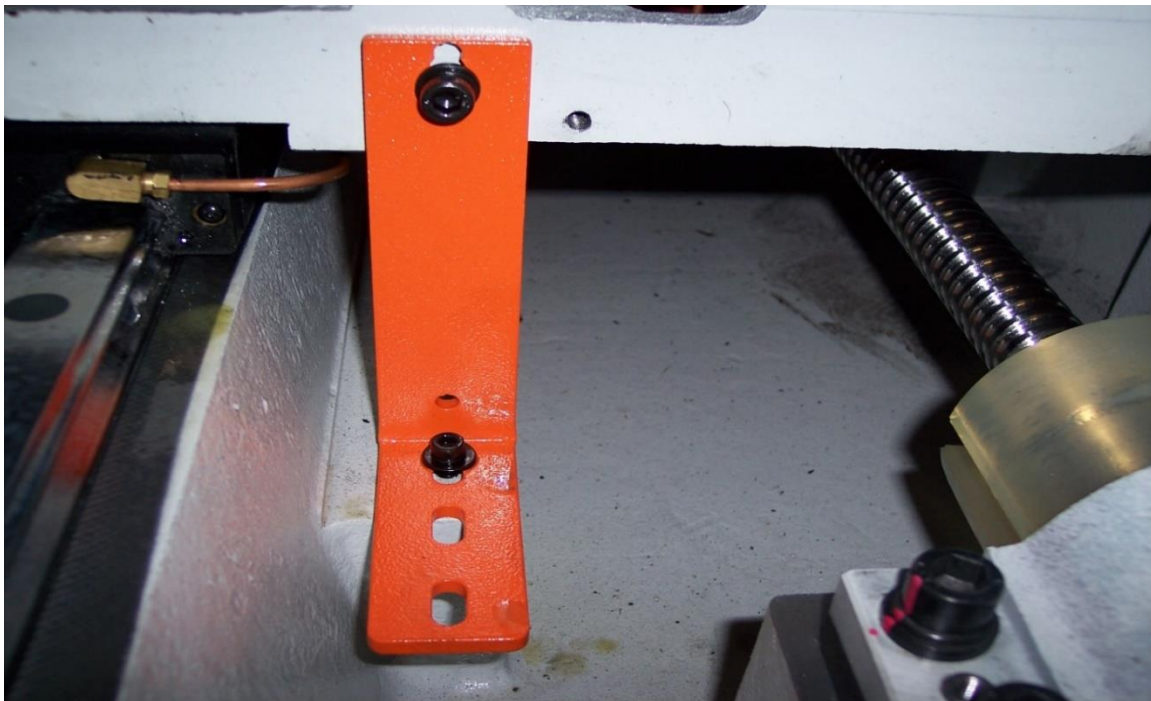

Figure 2.5a

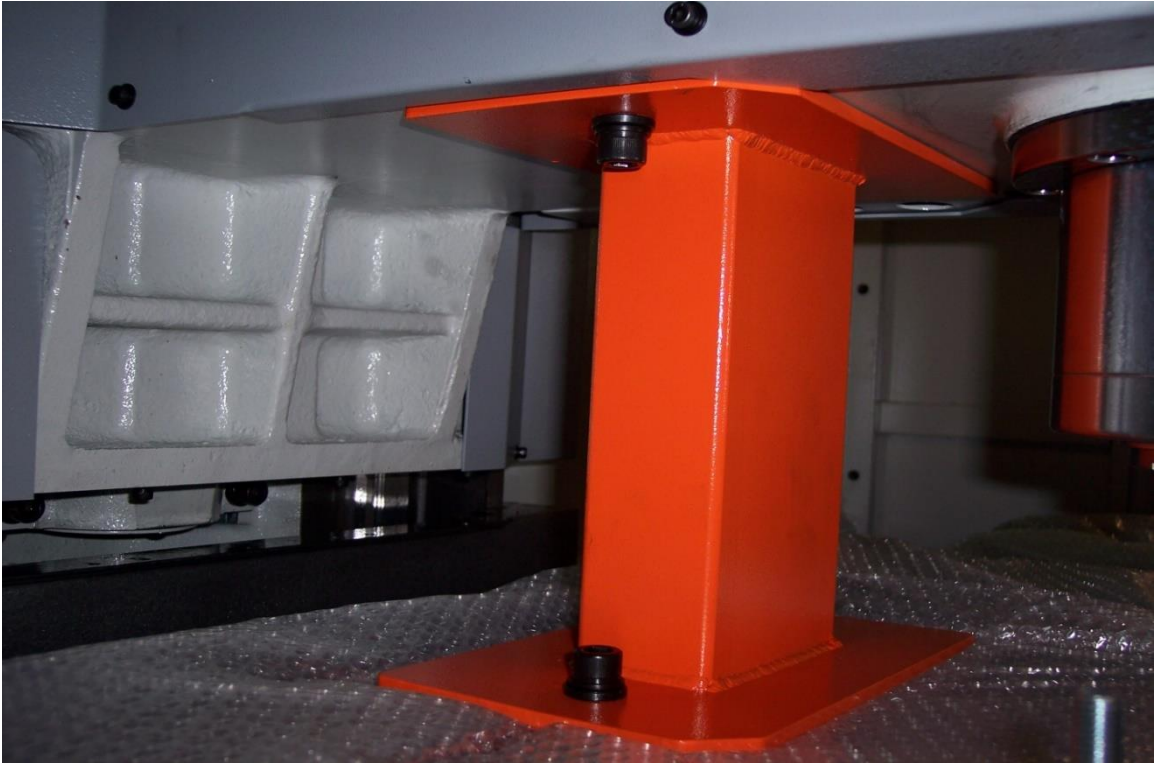

Figure 2.5b

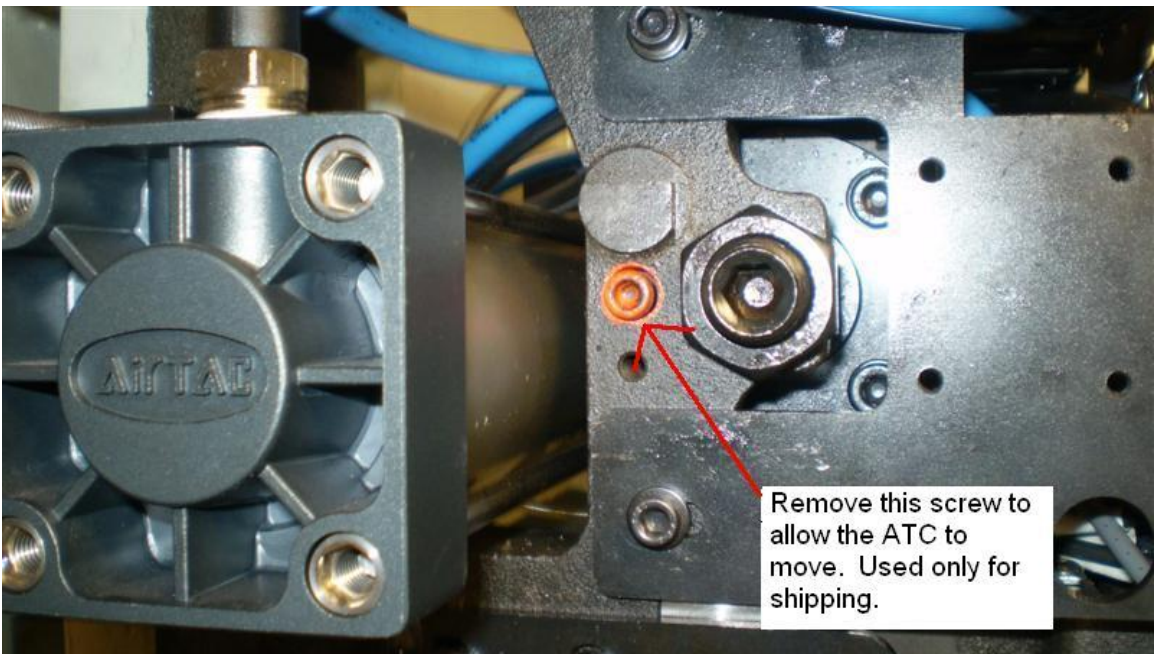

Figure 2.5c



Figure 2.5d



Figure 2.5e

2.5.1 Releasing the Head Support Bracket

1. Start with TMC machine under power.
2. Remove screws from head support that attach to the table and ram as shown in figure 2.5b.
3. Press power reset to turn servos on.
4. Run SERV CODE 505, select EHW, select Z axis using 0.01 resolution.
5. Slowly rotate Z EHW clockwise to raise Z Axis off head support bracket.
6. Remove support.

2.6 Leveling Procedure

Leveling the TMC in the field consists of leveling the machine and then adjusting the level, if necessary, to make sure the tram of the spindle is perpendicular to the table. Refer to figure 2.6.1a, 2.6.1b or 2.6.1c for the Leveling Pad Dimensions and Locations for your specific TMC.

2.6.1 Leveling Pad Specifications

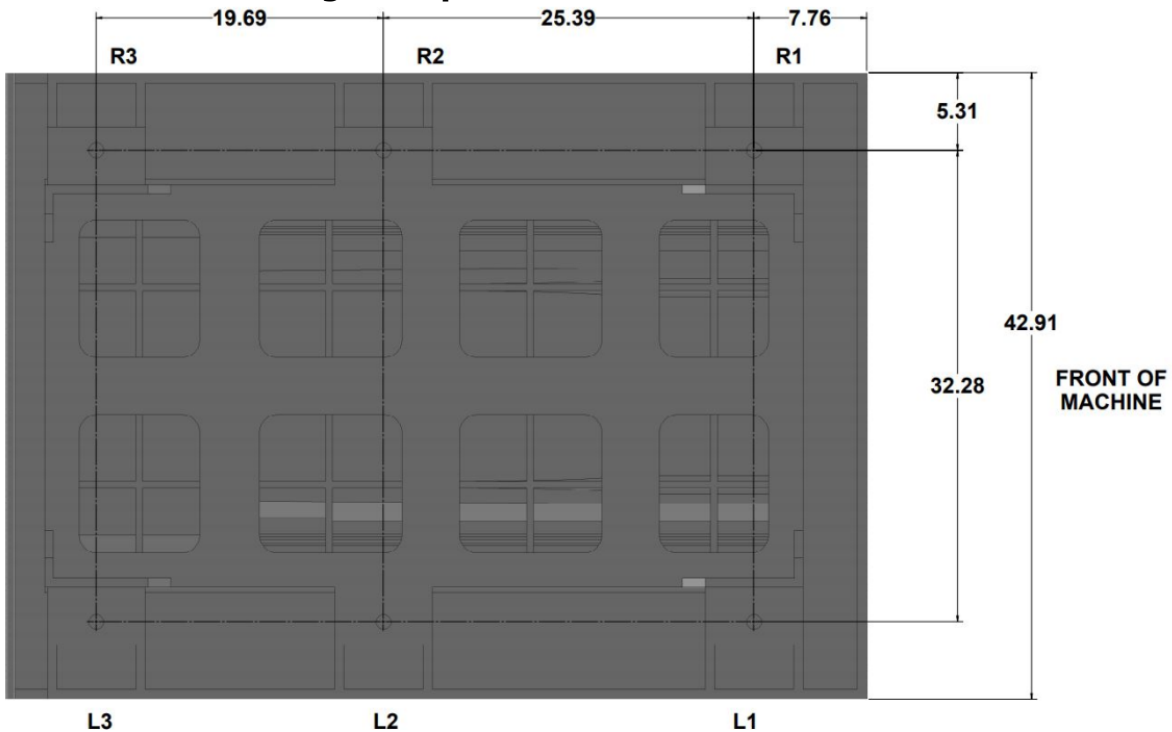

Figure 2.6.1a - TMC5 Leveling Pad Dimensions

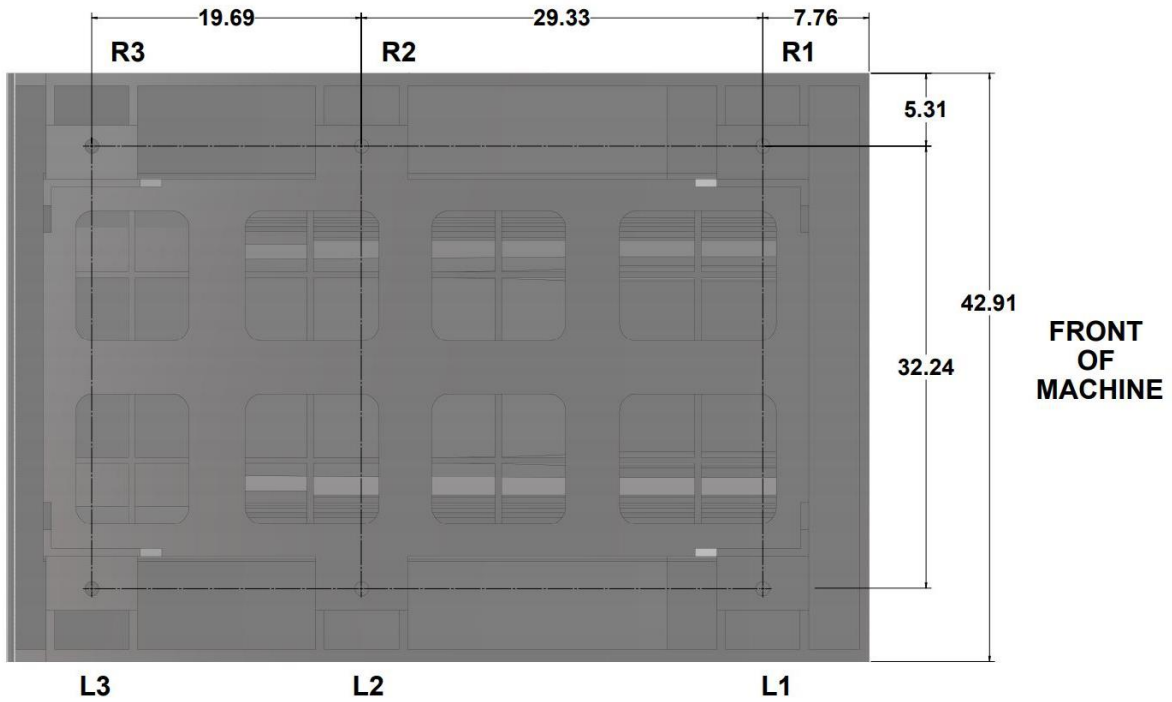

Figure 2.6.1b - TMC7 and TMC10 Leveling Pad Dimensions

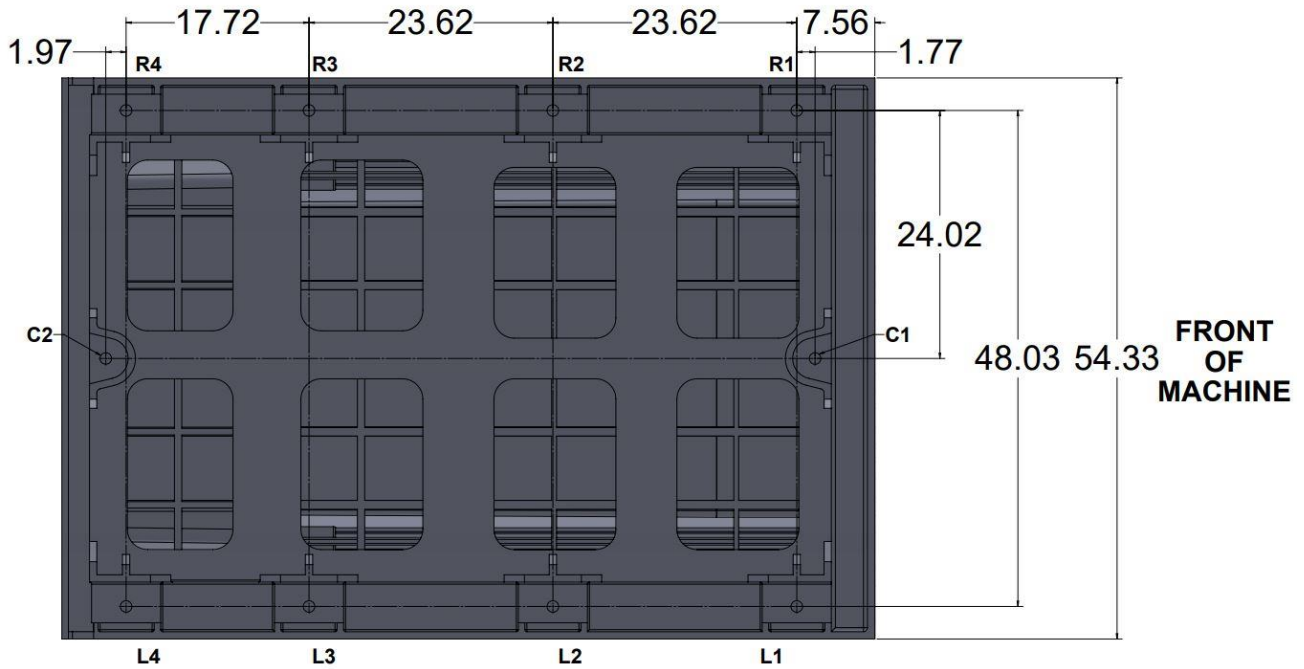

Figure 2.6.1c - TMC12 and TMC14 Leveling Pad Dimensions

2.6.2 Leveling Procedure

1. Set the TMC7 and TMC10 machines on its 4 leveling pads L1, L2, R1, & R2 on a solid, level floor prepared in accordance with the state and local rules for machine tool installation. For the TMC5, adjust the level with L1, L3, R1 and R3.
2. Clean the table thoroughly and place 1 or 2 precision Spirit levels or electronic levels in the center of the table in the positions illustrated in figure 2.6.2b.

CAUTION!

If using 2 levels, make sure each level is measuring correctly. To check, place the level in one direction and note reading and then flip 180° and see if the reading is the same. If not, have the level recalibrated.

3. On the TMC7 and TMC10, leveling is achieved by using leveling screws R1, R2, L1 and L2. See figure 2.6.1b. Adjusting screws R3 and L3 should be left loose with the leveling pads and have no pressure at this time. A 36 mm wrench is required to adjust the leveling bolts.
4. On the TMC5, leveling is achieved by using leveling screws R1, R3, L1 and L3. See figure 2.6.1a. Adjusting screws R2 and L2 should be left loose or just snug with the leveling pads and have no pressure at this time. A 36 mm wrench is required to adjust the leveling bolts.
5. On the TMC12 and TMC14, set all 10 leveling pads touching the ground. Leveling is achieved by using the seven leveling screws C1, L1, L2, L3, R1, R2, and R3. See figure 2.6.1c. All seven are tightened with about equal torque while adjusting screws C2, L4 and R4 should be left loose left loose with the leveling pads and have no pressure at this time. A 36 mm wrench is required to adjust the leveling bolts
6. With the precision levels placed on the worktable as shown in 2.6.2b, level the TMC to within 0.0005"/10 in.
7. If the machine must be anchored to the floor, follow the general instruction for installing machine tools when anchoring.
8. If the machine must be installed on vibration mounts/pads (rubber, commercially available leveling and vibration mounts, etc.) follow the instructions delivered with the mounts/pads, ordering them to satisfy the load of the machine and the maximum weight of the workpiece (~10,000 lb.).
9. When machine is correctly leveled, lock the adjusting screws in place with their hex nuts. See figure 2.6.2a.



Figure 2.6.2a

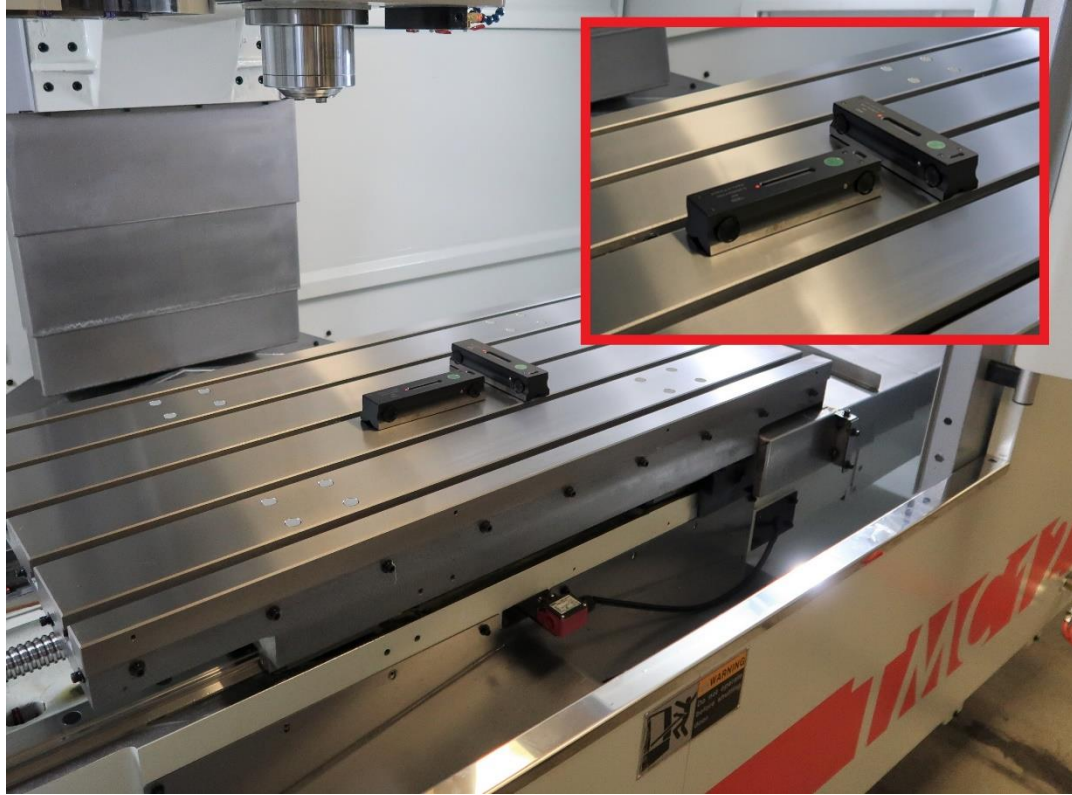

Figure 2.6.2b

2.6.3 Adjusting Level for Tram

1. Mount the .0001" test indicator to the spindle nose and sweep the table with a 12" span (6" radius).
2. If the tram measurement is not .0008 TIR on the TMC7 and TMC10, adjust the R3 and L3 leveling bolts to adjust the tram within specification. This will tend to help adjust any error you have in the X and Y axis for the tram. By adjusting these bolts, you can in affect slightly affect the column and bring in the tram.
3. If the tram measurement is not .0008 TIR on the TMC5, adjust the R2 and L2 leveling bolts to adjust the tram within specification. This will tend to help adjust any error you have in the X and Y axis for the tram. By adjusting these bolts, you can in affect slightly affect the column and bring in the tram.
4. If the tram measurement is not .0008 TIR on the TMC12 and TMC14, adjust the C2, L4 and R4 leveling bolts to adjust the tram within specification and not necessarily having equal pressure. This will tend to help adjust any error you have in the X and Y axis for the tram. By adjusting these bolts, you can in slightly affect the column and bring in the tram.
5. Once complete, lock all leveling screws in place with the lock nuts. See figure 2.6.2a

2.7 Shortages: Inventory Checklist

The following items will come standard with the TMC. Please note any optional items that have been ordered are present.

Loose Accessories Checklist:

Loose Parts See figure 2.7a

- (1) Self-coiling air hose – P/N 26961
- (1) Air nozzle – P/N 26960
- (1) Coolant nozzle and fitting – P/N 26958
- (1) 10' 120 PSI rated hose – P/N 26959
- (1) Air and coolant nozzle bracket



Figure 2.7a - Loose Parts Photo

Loose Parts See figure 2.7b

- (1) Toolbox – P/N 27646
- (1) Set of touch-up paint (1 can RAL 7035, 1 can RAL 7040, & 1 can of hardener) P/N 27644
- (1) 36mm Open End Wrench – P/N 27643
- (2) Leveling pads boxed on pallet

Note - (6) Leveling pads are shipped with TMC, (4) are located under the mill, on the pallet when delivered, and (2) are included on the pallet.



Figure 2.7b - Loose Parts Photo

Loose Large Items shipped Inside or with TMC

(4) Skirts

(1) X & (2) Y Axis Covers

(1) Large Coolant Tank with coolant and coolant wash pumps installed

(1) Auger motor and chute standard on TMC 7 & 10, optional on TMC 5

Brackets fastened to machine and need removal

(1) Column support bracket

(1) Bed shipping bracket

(1) X-axis shipping bracket

2.8 Electrical Connection

The TMC5, TMC7, and TMC10 are configured for 208-volt 3 phase electricity (200 to 240 volts is acceptable).

If 480-volt, 3 phase power is present, you must use a step-down transformer to 208-volt, 3 phase. Incoming 208 V power connects to the machine through the electrical box located on the back of the column. The power cable enters the electric's box through a hole on the top of the box.

DANGER!

Be certain that 208-volt electricity (typical range 200 – 240V) is used.

DANGER!

The 208-volt line must originate from a dedicated and independent fused box with a manual shut-off lever. It is the responsibility of the purchaser to supply a wired box that meets all local codes and regulations.

TRAK Machine Tools recommends the machine be earth grounded by driving a copper rod into the ground. It is the responsibility of the customer to install this rod.

DANGER!

Only a qualified electrician should wire the 208-volt 3 phase electricity.

2.8.1 Main Power to the Machine Connections

The 3 phase 220 voltage (208 – 240 V acceptable) is connected to L1, L2 and L3 at the power switch inside the electrical box. Connect the ground wire as shown in the figures 2.8.1 and 2.8.2.

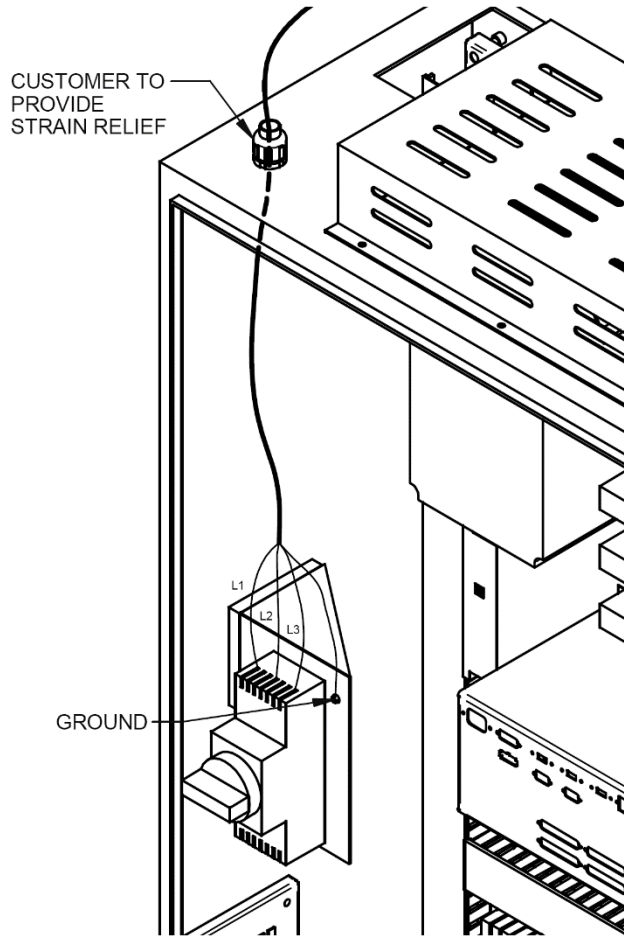

i26571

Figure 2.8.1

2.8.2 Transformer Option

The TRAK TMC comes with an optional step-down transformer, which takes 480 volts down to 220 volts. The transformer comes with multiple taps to allow for up to 3 different input voltages. The 3 taps are rated for 480 volts down to 220 volts. See figure 2.8.2a. The machine ships out from the factory with the wires attached to the 440-volt taps. Please adjust these 3 wires depending on the input voltage to the machine.

There is also a 200-volt and 220-volt tap on the secondary side of the transformer. In most cases the wires will be on the 220-volt tap. As a general rule, we would like the output voltage from the transformer to be between 220 and 230 volts. On a rare occasion where the customer's shop is around 500 volts, it may be necessary to move the wires from the 220 to 200-volt tap. You should also place the primary side wires on the 480 taps.

In the case of 415 volts, it is better to place the wires on the 400-volt taps as the output voltage will be closer to 230 volts.

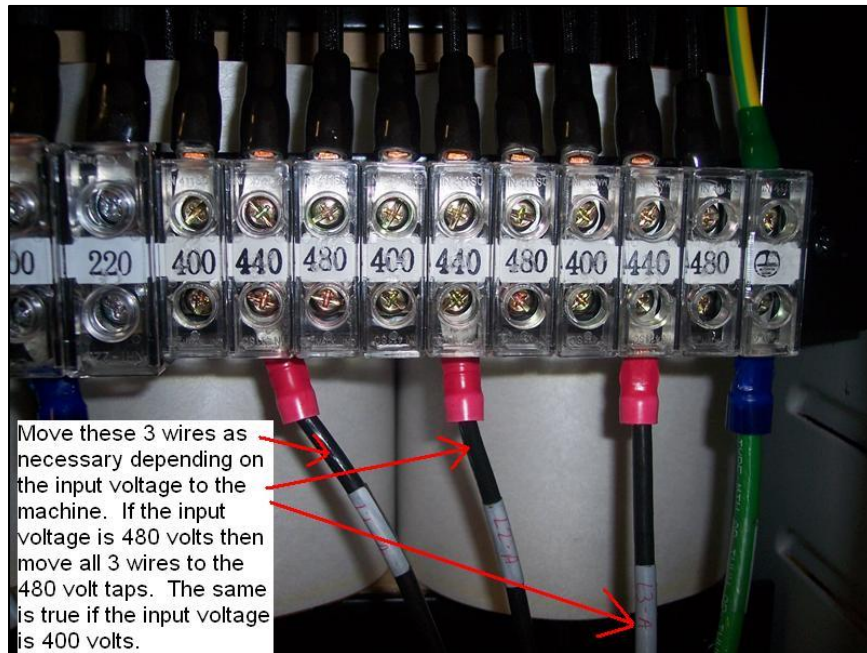

Figure 2.8.2

2.9 Air Connection

Connect the air supply to the quick disconnect coupling to the left of the pressure regulator and beneath the in-line air switch. The air supply line should have a minimum of ½" inside diameter. It is recommended that a water separator or air dryer be installed upstream of the TMC air supply. Connect the air supply to the quick disconnect coupling to the left of the pressure regulator and beneath the in-line air switch. The air supply line should have a minimum of ½" inside diameter. It is recommended that a water separator or air dryer be installed upstream of the TMC air supply.

2.9.1 Air Regulators and Solenoids

The TMC consists of 2 air regulators, 3 air flow valves and 3 solenoids that need no adjustment. They are all set at the factory but should be checked upon installation.

The main air regulator for the machine should be set at 90 psi and the secondary one that supplies air to the spindle cartridge should be set at 7 psi. These regulators are adjusted by pulling the cap upward and rotating the cap clockwise to increase the air pressure and CCW to decrease the air pressure.

The 3 air flow valves should be set at the factory but can be checked as follows. For the valve that controls the flow of air through the spindle during a tool change, close this valve and open it 6 or 7 turns and then lock it in place as shown in figure 2.9.1a. For the other 2 valves that control the speed by which the ATC moves in and out, they should be opened all the way and locked in place as shown in figure 2.9.1b.

The in-line air switch shown in figure 2.9.1b turns the system air on and off, put the collar in the lowered position (off) before connecting the air supply. Push upward to turn on the air.

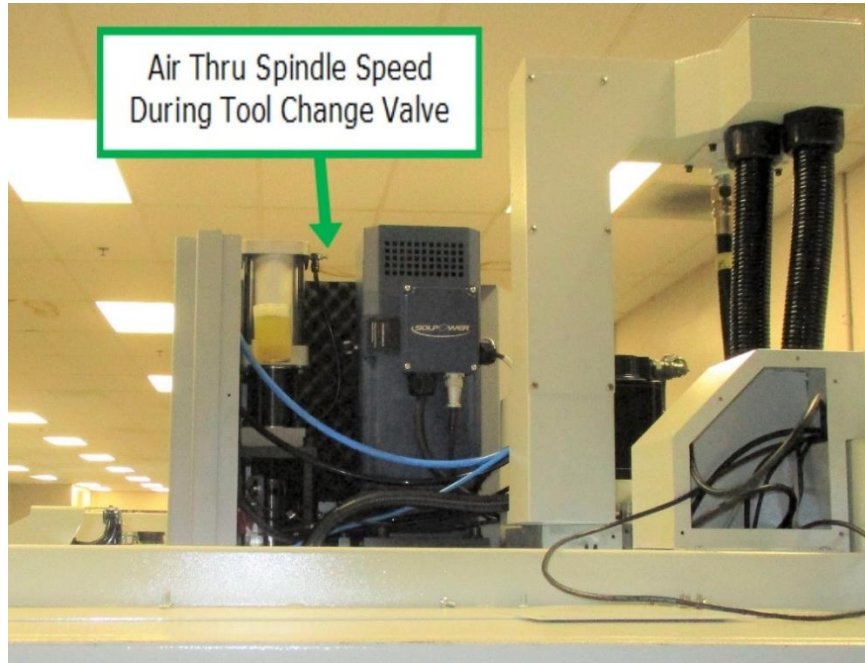

Figure 2.9.1a

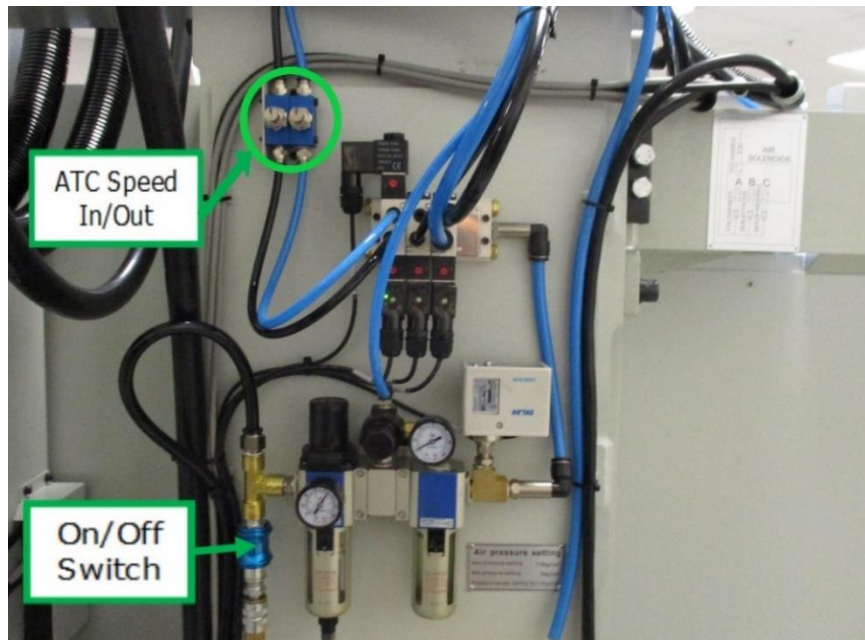

Figure 2.9.1b

The 3 air solenoids standard on the TMC provide switches to regulate air flow for the ATC In and Out, air blast for tool and air flow thru the spindle and locations are shown in figure 2.9.1c.

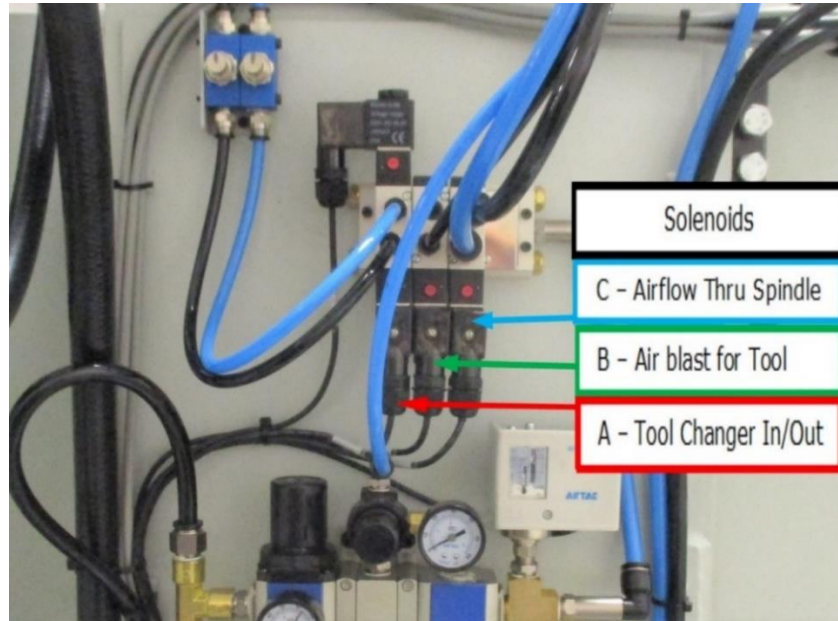

Figure 2.9.1c

2.10 Placing the Coolant System

1. Locate coolant tank beneath the rear of the machine.
2. Remove loose ends of coolant hoses from the underside of the TMC enclosure and route them to the pumps. The hoses and fittings are labeled prior to shipping.
3. Attach and secure these hoses with hose clamps per the figure 2.10 below:

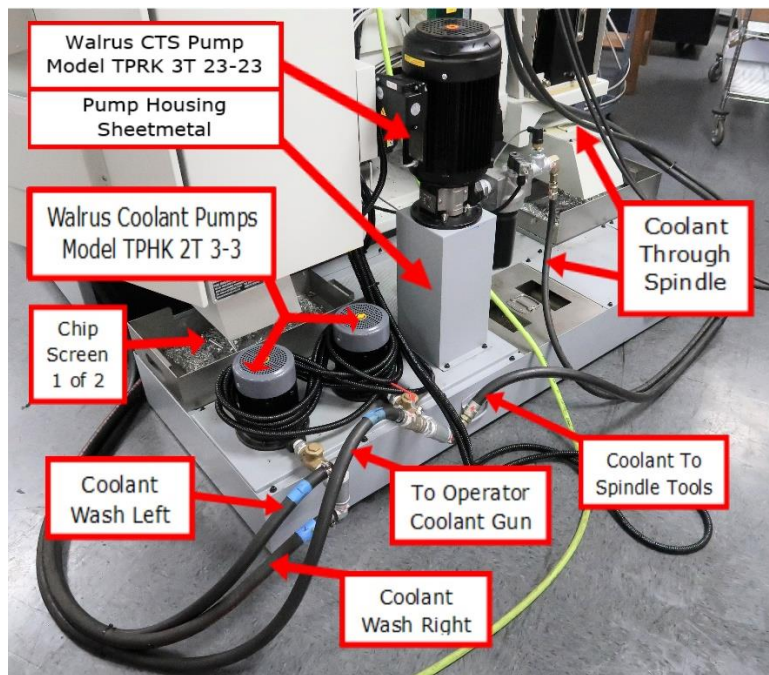



Figure 2.10

2.11 Installation Checklist

Installer – Use this checklist to assure a complete setup on the TMC.

Installation Checklist	
<input type="checkbox"/>	1. Shut off power to the machine.
<input type="checkbox"/>	2. Visually inspect the 208-volt wiring (or 480-volt if transformer option is installed) going into the electrical panel. Visually verify the wiring is correct per our wiring diagram and the voltage is between 200 and 240 volts. Make sure a strain relief is being used where the wiring enters the cabinet. Have the customer repair any wiring discrepancies. See figure 2.8.1a and 2.8.2a. Double check how the machine has been grounded and notify user if it is not done per our recommendations. See sections 2.8 & 2.8.1 for recommended grounding.
<input type="checkbox"/>	3. If 480-volt transformer option is installed, measure incoming voltage and adjust transformer taps as necessary. See section 2.8.2a.
<input type="checkbox"/>	4. Clean the machine if needed and remove any remaining protective grease.
<input type="checkbox"/>	5. Unlock table, saddle, head and tool changer by removing support brackets WARNING! Refer to section 2.5 before proceeding. Install 2 door handles on front door.
<input type="checkbox"/>	6. Install auger motor as it ships in a separate box. Auger screw fastens to motor shaft with 2 set screws and 2 brass pieces as shown. Hardware bagged and attached to auger motor.



Installation Checklist

- 7. Reinstall rear coolant bracket which prevents leaking of coolant through the rear of the machine. Hardware provided on coolant tank.

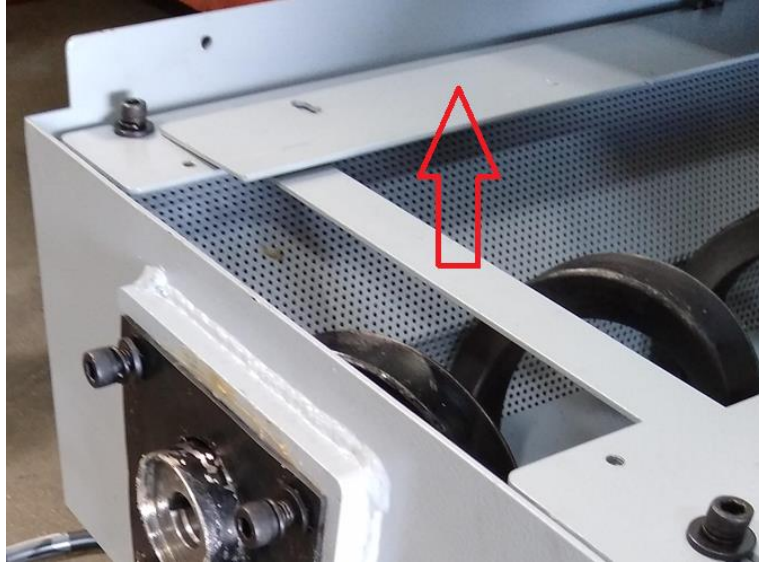

- 8. Wire up the auger, coolant pump and coolant wash pumps per section 5.1.8.
- 9. Re-attach the Z motor power and encoder cable if it was disconnected during shipment. Make sure to thread the cables on all the way.
- 10. Install the X and Y EHW's if they were sold with the machine. Reattach the cable carriers to the bottom portion of the EHW trough.
- 11. Turn on the power to the machine. Verify the lube pump cycles 1 time when machine is turned on.
- 12. Adjust air pressure on the main air regulator to 90 psi. Adjust air regulator for the spindle cartridge to 7 psi.

Installation Checklist

- 13. Prior to setting the machine down, thread each leveling bolt down approximately 1.25" as measured from the bottom of the leveling bolt to the bottom of the casting.



Prior to adjusting the final level on the machine, slide the coolant tank under the machine with the coolant chutes in place. Make sure the slots on the chutes are all the way up as shown. Now lower the chutes to confirm they reach the coolant tank and are flush or maybe a little of the way down inside the coolant tank. If the chutes do not reach the tank, then lower the machine with the leveling screws. This will allow the coolant/chip chutes to come down and minimize any coolant splashing.

Note - One of the coolant/chip chutes will need to be reattached as it is shipped separately with the machine.



- 14. Check the level of the machine. The machine should be level to within 0.0005"/12 inches front to back and 0.0005"/12 inches side to side. Adjust leveling feet as necessary to adjust for the spindle tram should it be out of spec.

Installation Checklist

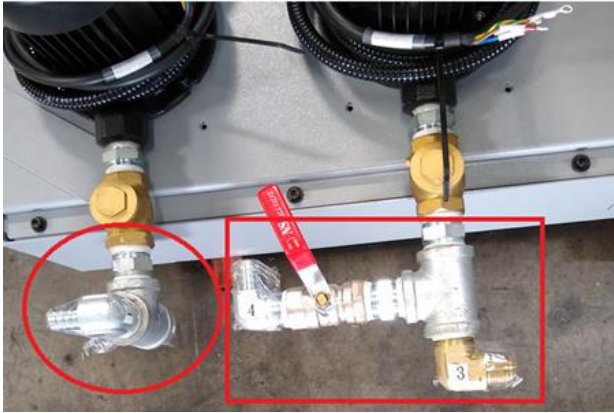
<input type="checkbox"/>	<p>15. Install coolant pump and coolant wash fittings as they are removed during shipment. Install hoses labeled 1 through 4 to the corresponding fittings labeled 1 through 4. Refer to section 2.10.</p> 
<input type="checkbox"/>	<p>16. Temporarily fasten the left side X axis way cover and front Y axis way cover prior to homing. This is to ensure we don't damage these covers by accident. We say temporarily because you should remove it again to check lubrication as step 18 states.</p>
<input type="checkbox"/>	<p>17. Press SET HOME to home machine. Did the X axis home properly? Did the Y axis home properly? Did the Z axis home properly? Did the ATC home properly? Station # 1 should be at the tool change position.</p>
<input type="checkbox"/>	<p>18. Jog the X, Y and Z axis back and forth until the linear guide surfaces are well lubricated. Oil should be visible on all the linear guide surfaces and ball screws. Once lubrication is verified, attach all way covers.</p>
<input type="checkbox"/>	<p>19. Go to DRO mode and move each axis in a positive direction. Select the X axis, does the table move to the left when turning EHW CW? Select the Y axis, does the saddle move toward the operator when turning the EHW CW? Select the Z axis, does the head move up when turning the EHW CW? Check that 1 click of the EHW in FAST mode is 0.100"</p>
<input type="checkbox"/>	<p>20. Double check the motor index angle for each axis using service code 505. Index angles must be checked in the positive direction, towards the homing switch. If this needs to be modified on the Z axis, then re-set the tool change height with service code 501.</p>
<input type="checkbox"/>	<p>21. If you have the EHW option then perform these checks: Make sure the EHW's on each axis work properly in FINE and COURSE mode. In Tool Room Ops, pull out the Z EHW from its parked position and move the head up as high as it can go and confirm you get a flashing Z EHW SOFT LIMIT message. In Production Ops, pull out the Z EHW from its parked position and try to run a program. Verify the control produces a fault message stating the Z EHW must be parked.</p>
<input type="checkbox"/>	<p>22. Final test each axis by using the JOG button. Verify the machine does not hit the hard stop on the machine. Re-adjust Home switch cam if it does. If the Z axis is adjusted, then service code 501 may need to be performed. The soft limits are set in service code 505, adjust as required but this should come from the factory with no changes necessary.</p>
<input type="checkbox"/>	<p>23. Install Y axis way cover bracket between front and rear way cover. Install the lower 3 sheet metal skirt covers on the front and sides of the machine.</p>
<input type="checkbox"/>	<p>24. Check to make sure that the E-Stop button is functioning correctly. Turn spindle on and power feed an axis. Press the E-stop button during this operation and verify the spindle and axis stops.</p>

Installation Checklist	
	You will need to press the POWER RESET button once this is done. Make sure the Z axis does not move when the E-stop is pressed. The brake on the Z axis motor will hold the head.
<input type="checkbox"/>	25. Turn the auger (chip conveyor) (an option on TMC5) on in the forward and reverse directions and make sure it turns in the correct direction. You need to hold the REVERSE key down for the auger to turn in reverse. FWD should cause the auger motor to turn CCW when viewing from the rear of the motor.
<input type="checkbox"/>	26. Turn the coolant wash pump on and make sure it rotates in the correct direction (Clockwise). Note - Coolant coming out of the wash down nozzles is not an indication that the pump is turning in the proper direction. Observe the direction of the motor fan.
<input type="checkbox"/>	27. Install the coolant and the air hoses to the front of the machine. Confirm the bracket to hold these hoses is installed on the right side of the pendant enclosure. Confirm both hoses work and do not leak.
<input type="checkbox"/>	28. Turn the coolant pump on by pressing the coolant ON button and make sure it rotates in the correct direction (Clockwise). Note - Coolant coming out of the nozzles is not an indication that the pump is turning in the proper direction. Observe the direction of the motor fan.
<input type="checkbox"/>	29. Turn the AIR blast on by pressing the Air ON button. Open and close the valves and make sure there are no leaks.
<input type="checkbox"/>	30. Is the spindle motor fan running? Is it turning in the correct direction? Air should be blowing up and away from the motor.
<input type="checkbox"/>	31. Close the door and make sure the control recognizes the door as being closed when in production ops. When the door is open a DOOR OPEN message should be on the screen when in DRO mode. It goes away when the door is closed. In tool room ops, there should be no DOOR OPEN message since you can run with the door open. Press the DOOR LOCK button to enable the door lock, powerfeed an axis and make sure the door is locked when the machine is moving while in production ops.
<input type="checkbox"/>	32. Press the manual tool change button on the head (GREEN button) and make sure air is coming down through the spindle. Adjust as required. Put a tool in the spindle and verify the tool clamps once the green button is released.
<input type="checkbox"/>	33. Move the ATC completely around all 16 stations using the ATC LOC # button in the tool table. The door must be closed and you must be in Production Ops. Also make sure the ATC is rotating in the correct direction.
<input type="checkbox"/>	34. Double check the tool change height with service code 501. Once verified, check to make sure that the tools load and unload properly into the tool carousel, the tool should not deflect as the tool is being loaded automatically into the spindle
<input type="checkbox"/>	35. Physically load a tool in and out of the carousel to make sure the orientation angle and tool change height are correct. This can be done by assigning a library tool to the ATC. Use CALL TOOL to bring it back to the spindle.
<input type="checkbox"/>	36. Turn off air to the machine (in-line switch) and verify the control recognizes low air pressure. There should be a warning message on the screen.
<input type="checkbox"/>	37. Run spindle in DRO in forward and reverse at low speeds.
<input type="checkbox"/>	38. Run the 10-minute warm up program.

Installation Checklist	
<input type="checkbox"/>	<p>39. Spindle head test Run spindle at 1000 RPM for 5 minutes Run spindle at 8000 RPM for 5 minutes. Must be in Production Ops. Run spindle at 500 RPM increments for a few seconds per increment. Please note any of the following: Head noise, excessive heat on spindle, vibration, spindle fan noise.</p>
<input type="checkbox"/>	<p>40. Make sure the "ATC Tool Detect Sensor" is working and seeing a tool in the location. Reference section 4.4.3 in manual. It is recommended to add 3 tools side by side in ATC to verify it only sees the tool for the spot that is in front of it. Check the tool in spindle sensor is working properly. Load a tool in the spindle when the tool status bar says NO TOOL and you should see the status bar change to say TOOL #? and be highlighted in yellow. Remove tool and it should go back to NO TOOL.</p>
<input type="checkbox"/>	<p>41. In production ops, run one of the axis rapid test programs in the TMC Inspection Programs folder called AXIS RAPID TEST TMC5 OR 7 or 10.PT10. This will run machine at maximum rapid speed. Confirm machine runs with no issues. See NOTES section of program for how to set up program.</p>
<input type="checkbox"/>	<p>42. If the user ordered an RSG, plug it in and verify it works.</p>
<input type="checkbox"/>	<p>43. Assemble the tool measurement cart and tool measurement gage if this option was ordered. Make sure to align the tool measurement gage per the instructions included with the kit. Make sure to attach the SWI logo that comes in the hardware kit to the cart.</p>
<input type="checkbox"/>	<p>44. If CTS option is ordered:</p> <ul style="list-style-type: none"> <input type="checkbox"/> • Wire up the CTS pump and clog sensor and attach hose fittings to the CTS pump filter. <input type="checkbox"/> • Fill the supply tank with the coolant and turn the CTS pump on making sure it rotates in the correct direction (There is an arrow on the motor to check this). NOTE-Coolant coming out of the spindle is not an indication that the pump is turning in the proper direction. <input type="checkbox"/> • Test filter dog sensor: <ul style="list-style-type: none"> <input type="checkbox"/> ○ With the pump turned on and unplug the inputs to see the CTS FLOW IS LOW message flash on the screen <input type="checkbox"/> • Calibrate the coolant pressure sensor: <ul style="list-style-type: none"> <input type="checkbox"/> ○ Remove any tool from the spindle prior to calibration <input type="checkbox"/> ○ Using a screwdriver slowly tighten the screw on the top center of the sensor approximately 1/8th of a turn per second. <input type="checkbox"/> ○ When the machine faults out, loosen the screw ¼ turn, and clear the fault on the pendent. <p><input type="checkbox"/> Run the CTS pump for 10 minutes and check for leaks. Please note that the spindle does not need to be turned on during this process.</p>
<input type="checkbox"/>	<p>45. Remove front door sill protective material.</p>
<input type="checkbox"/>	<p>46. If machine came with a 4th axis, please see 4th axis installation checklist in section 6.</p>
<input type="checkbox"/>	<p>47. Wipe down machine.</p>

2.12 Lubrication

2.12.1 Way Lubrication

The auto lube system provides centralized automatic lubrication for the linear guides and ballscrews. The lube pumps 1-liter reservoir is serviced with ISO VG 32/SAE 10W slideway oil. The pump is factory set to distributor 2.7 ml of oil for every cycle of the lube pump. The lube pump cycles automatically 1 time upon initial startup of the control and then 1 cycle for every 30 minutes of axis movement time. Each cycle of

the lube pump lasts for 5 seconds or so, once the lube pump is turned off, oil is then discharged from the spring loaded oil manifolds to the linear guides and ballscrews.

Discharge Pressure - Approximately 200 psi

To adjust the amount of Discharge Pressure displayed on the lube pump gauge, turn the adjustment screw clockwise to increase the pressure. 1 turn of this screw will raise the pressure about 100 psi.

At the beginning of each day, check the oil level in the Auto Lube system. If low, fill with ISO VG 32/SAE 10W slideway oil. If the lube pump runs dry or has low pressure, a flashing message will appear on the screen that says LOW OIL or LOW PRESSURE. The control will allow the machine to complete its current cycle and not allowing it to run the next part until the lube oil gets replenished.

CAUTION!

Failure to manually activate the pump at the beginning of each day if the control was left on and the machine has been idle for a long period of time may cause severe damage to the TRAK TMC linear guides and ballscrews.

To manually activate the lube pump, use service code 300. Repeat this process 2 or 3 times.

2.12.2 Other TMC Lubrication Points

1. Tool Change Air Cylinder Oil Cup supplies oil to the "Air Over Oil" cylinder and should not require replenishment. However, if it does fill the oil cup on the front of this cylinder with ISO VG 32/SAE 10W slideway oil.
2. Oiler
Once every 2 weeks:
Fill the oiler that supplies lubrication to the solenoid valves and other various components within the pneumatic system with ISO VG 32/SAE 10W slideway oil. It holds approximately 5 ounces.
3. Grease fitting on ATC
Yearly:
Apply a good grade of general-purpose grease like Shell GADUS S3 V220 C2 or equivalent through the grease fitting on the top of the ATC. This provides lubrication to the sliding rails as the ATC moves in and out from the spindle. Make sure to supply enough grease to distribute grease through the grease line that connects between the top and bottom rail.

2.13 Machine Specifications

MODEL NAME	TMC5	TMC7	TMC10
Table Size	27.56" x 15.75"	35.43" X 19.69"	44.09" x 19.69"
T-Slots (number x width x pitch)	3 x 18 x 100 mm 3 x .709" x 3.937"	5 x 18 x 100 mm 5 x .709" x 3.937"	5 x 18 x 100 mm 5 x .709" x 3.937"
Travel (X, Y, Z axis) with Soft Limits	20" x 16" x 20"	30" x 20" x 20"	40.75" x 20" x 20"
Travel (X, Y, Z axis) with No Soft Limits *User may cause damage if they crash. Travel distance is just shy of hard stops	21.25" x 17.50" x 21.25"	30.75" x 21.25" x 21.25"	42" x 21.25" x 21.25"
Spindle Taper	40 Taper		
Spindle Speed Range – Production Ops	50-8000		
Spindle Speed Range – Production Ops with 12K spindle option	50-12,000		
Spindle Speed Range – Tool Room Ops	50-5000		
Spindle Nose Diameter	3"		
Tool Clamping Force (90 psi)	1500 lbs.		
Tool Holder Type	CAT 40 or BT40		
ATC Tool Capacity	16		
Maximum Tool Weight Including Holder	15 lbs.		
Maximum Tool Diameter	3.14"		
Carousel Speed	.8 sec from station to station		
Tool Selection System	Bi-directional/ shortest path		
Retention Knob	See drawing of retention knob		
Spindle Motor Power (continuous)	10 HP Full load amps 27.7		
Spindle Motor Power (peak)	15 HP		
Power requirements – 208V (volts, phase, current) 8k Spindle	208V (200-240V is acceptable), 3P, 68A (Current can be as high as 87 amps with all options ordered – CTS (+14 amps), 4 th axis (+5 amps))		
Power requirements – 208V (volts, phase, current) 12k Spindle	208V (200-240V is acceptable), 3P, 69A (Current can be as high as 88 amps with all options ordered – CTS (+14 amps), 4 th axis (+5 amps)) Includes cooler current		
Power requirements – 480V (volts, phase, current) 12k Spindle	480V with transformer option (432-528V is acceptable), 3P, 46A (46 amps-based nominal rated current of transformer)		
Power requirements – 480V (volts, phase, current) 12k Spindle	480V with transformer option (432-528V is acceptable), 3P, 46A (46 amps-based nominal rated current of transformer)		
Maximum Weight of Workpiece	880 lbs	1320 lbs	1760 lbs
Height of Table from Bottom of Bed ***	38"	38"	38"

MODEL NAME	TMC5	TMC7	TMC10
Minimum Spindle Nose to Table Distance****	3.5"	3.5"	3.5"
Maximum Spindle Nose to Table Distance****	23.50"	23.50"	23.50"
Distance of Tool Carousel to Table	18"	17.5"	17.5"
Spindle Center to Spindle Head Casting Face	16.50"	18.25"	18.25"
Minimum Machine Height ***	90"	90"	90"
Maximum Machine Height (head all the way up) ***	106.50"	106.50"	106.50"
Minimum Height to Fit TMC's Through Doorway **	84"	84"	84"
Length (pendant enclosure rotated at 90° and coolant tank in place)	129"	134"	134"
Overall width of machine no auger chute, auger motor or chip container	84"	97"	111"
With optional auger installed	94"		
Overall width of machine with side doors open and auger chute and chip container in place	138"	167.25"	165.50"
Overall length of machine with electrical cabinet full open 180°	142"	147"	147"
Footprint of Machine (width x length) (coolant tank in place)	84" x 129"	97" x 135"	111" x 135"
With optional auger	94" x 129.25"		
Weight (lbs.)	7260	8360	9900
Shipping Weight (lbs.)	7610	8710	10250
Rapid traverse X, Y, Z	400 ipm in Tool Room Ops 1000 ipm in Production Ops		
Coolant Capacity	56 gallons		
Coolant Pump and Wash Power	750 Watt		
Air - Pressure CFM or SCFM	2.5 CFM at 90 psi or 18 SCFM		
Air Quality	Air dried / water separator upstream of the TMC		
Lube Pump Capacity	2 liters		
CTS (Coolant Through Spindle) Power	3 KW		
CTS Max Pressure	319 psi		

* Specs subject to change.

** Must remove resistor and all sheet metal attached to top of electrical cabinet. The cable way for Z axis also needs to be removed. The lifting point on the electrical cabinet is now the highest point.

*** Height changes slightly based on how machine is leveled on leveling screws.

**** Can vary slightly due to home switch location and soft limit settings.

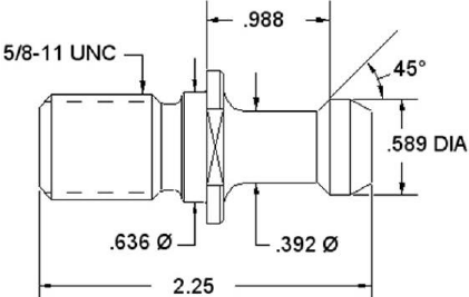
MODEL NAME	TMC12	TMC14
Table Size	23.62" x 51.18" 600 x 1300 mm	23.62" x 62.99" 600 x 1600 mm
T-Slots (number x width x pitch)	5 x 18 x 125 mm 5 x .709" x 4.921"	5 x 18 x 125 mm 5 x .709" x 4.921"
Travel (X, Y, Z axis) with soft limits	50" x 27" x 25"	60" x 27" x 25"
Travel (X, Y, Z axis) with no soft limits	~51.28" x 27.66" x 26.12"	~61" x 27.66" x 26.12"
Spindle Motor Power (continuous) – 8K	15 HP	
Spindle Motor Power (peak) – 8K	22.5 HP	
Spindle Motor Torque (continuous) – 8K	43.77 ft-lbs	
Spindle Motor Torque (peak) – 8K	65.66 ft-lbs	
Spindle Taper	40 Taper	
Spindle Speed Range – 8K	50-8000	
Spindle Motor to Spindle Pulley Ratio – 8K	1 to 1	
Tool Clamping force (90 psi)	2200 lbs	
Tool Holder Type	CAT 40 or BT40	
Spindle Nose Diameter	3 ¾"	
Diameter of spindle	70 mm	
# of Spindle Bearings	4 total - 2 lower and 2 upper	
Spindle Bearing Sizes	110 x 70 x 20 mm	
Spindle Cooler Oil Capacity (option)	TBD	
ATC Tool Capacity	16	
Maximum tool weight including holder	15 lbs	
Maximum tool diameter	3.14"	
ATC tool change time	.8 sec from station to station	
Tool selection system	Bi-directional/ shortest path	
Retention knob	<p>Same one used on all TMC and VMC machines</p> 	
# of X, Y and Z axis linear bearing blocks	<p>3 on each guide on X axis 2 on each guide on Y and Z axis</p>	

X, Y and Z axis linear guide size	45 mm	
X axis linear guide way span	380 mm	
Y axis linear guide way span	900 mm	
Z axis linear guide way span	440 mm	
X, Y and Z axis ballscrew diameter	40 mm	
Pitch of ballscrew (X, Y and Z axis)	10 mm	
Ballscrew accuracy class	C3	
Rapid traverse X, Y, Z	1000 ipm	
Cutting max speed X, Y, Z	1000 ipm	
Power Requirements – 208V (volts, phase, current) 8k spindle	208V (200-240V is acceptable), 3P, 93A <i>(Current can be as high as 112 amps with all options ordered - CTS (+14A), 4th axis (+5A))</i>	
Power Requirements – 208V (volts, phase, current) 12k spindle	208V (200-240V is acceptable), 3P, 96A <i>(Current can be as high as 115 amps with all options ordered - CTS (+14A), 4th axis (+5A))</i>	
Power Requirement – 480V (volts, phase, current) 8k spindle	480V w/ transformer option (432-528V is acceptable), 3P, 49A <i>(Current can be as high as 58 amps with all options ordered - CTS (+6A), 4th axis (+3A))</i>	
Power Requirement – 480V (volts, phase, current) 12k spindle	480V w/ transformer option (432-528V is acceptable), 3P, 49A <i>(Current can be as high as 58 amps with all options ordered - CTS (+6A), 4th axis (+3A))</i>	
Coolant Pump (Watts)	750	
Coolant Pump Pressure and Volume	32.8 liters/min at 3 kg/cm ² 8.7 gpm at 42 psi	
Coolant Wash Pump (watts)	1290	
Coolant Wash Pressure and Volume	66.3 liters/min at 3 kg/cm ² 17.5 gpm at 42 psi	
Tank Capacity	267 liters 70.5 gallons Use 71 gallons in spec	
Maximum Weight of Workpiece	1000 Kg 2200 lbs	1200 Kg 2640 lbs
Height of table from bottom of bed ***	38.37" 1000 mm	
Minimum spindle nose to table distance****	2.25" 57 mm	
Maximum spindle nose to table distance****	28.75" 735 mm	
Distance of tool carousel to table.	21.5"	
Spindle Center to spindle head casting face	27.56" 700 mm	
Minimum machine height ***	105"	

Maximum machine height (head all the way up) ***	120.5"	
Minimum height to fit TMC's through doorway. Remove Z motor and sheet metal on top of column	93"	
Length (pendant enclosure rotated at 90° and coolant tank in place)	144.76"	
Overall length of machine with electrical cabinet full open 180°	156.22"	
Overall width of machine no auger chute, auger motor or chip container	133.86"	157.48"
Overall width of machine with side doors open and auger chute and chip container in place	206.27"	224.13"
Footprint of Machine (width x length) (coolant tank in place)	133.86" x 144.76"	157.48" x 144.76"
Weight (lbs.)	14300 lbs 6500 kg	16500 lbs 7500 kg
Shipping Weight (lbs.)	14800 lbs 6727 kg	17000 lbs 7727 kg
Air - Pressure CFM or SCFM	3.0 CFM (at 90 psi) or 25 SCFM	
Air Quality	Air dried/ water separator upstream of the TMC	
Lube Pump Capacity	2 liters	
Lube Oil	ISO 32 or 10 W	

* Specs subject to change.

*** Height changes slightly based on how machine is leveled on leveling screws.

**** Can vary slightly due to home switch location and soft limit settings.

2.13.1 Maximum Spindle Torque & HP

The following graphs illustrate the continuous and peak torque vs RPM and horsepower vs RPM for the TMC machines at the spindle. Peak torque and horsepower values can only be attained for a short period of time before the spindle drive will fault out to protect the motor.

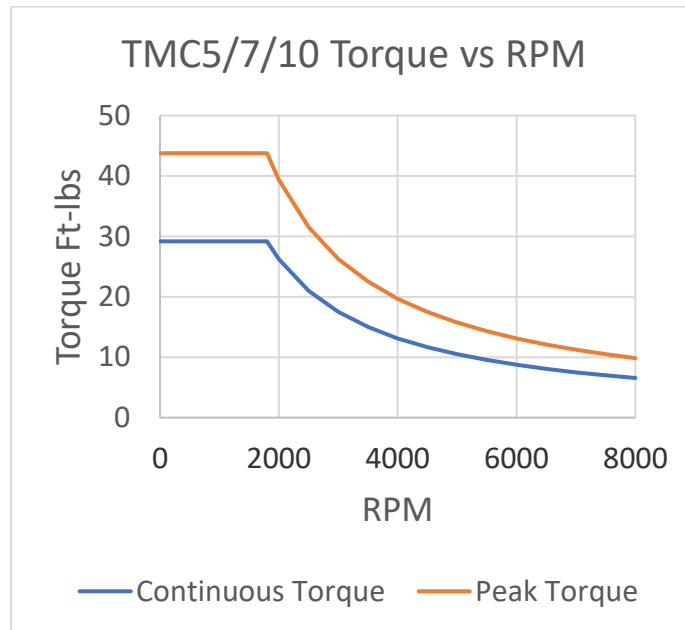

Figure 2.13.1a

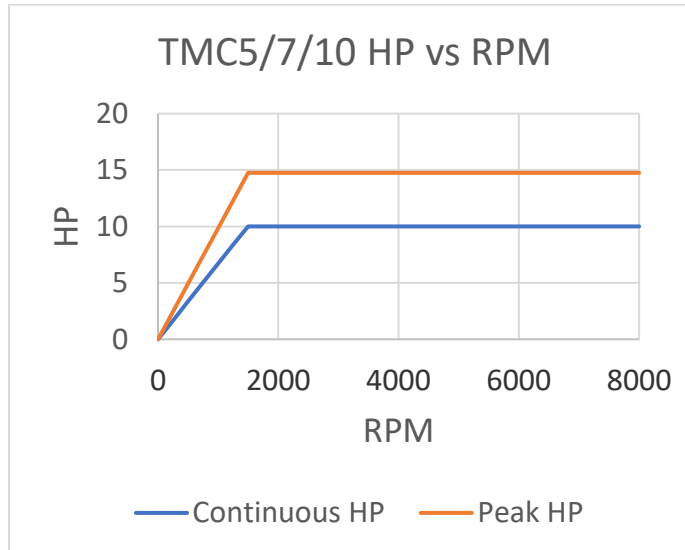

Figure 2.13.1b

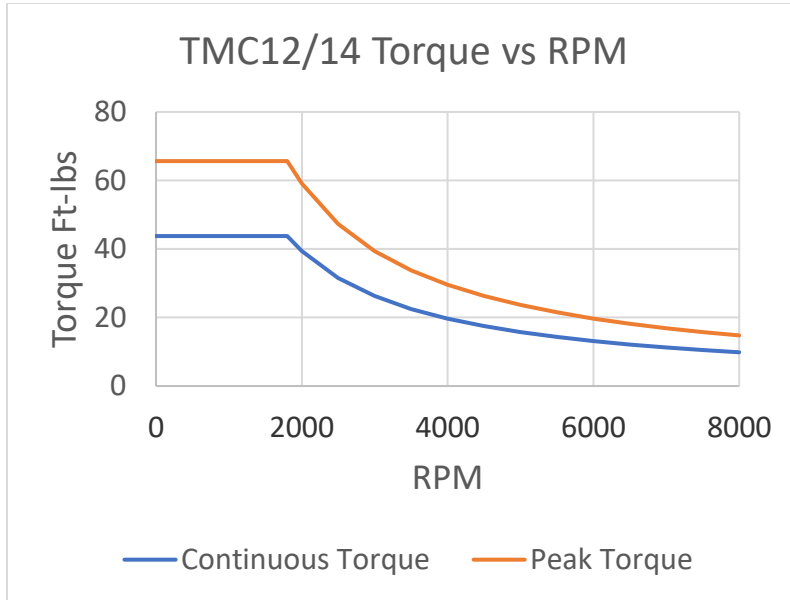

Figure 2.13.1c

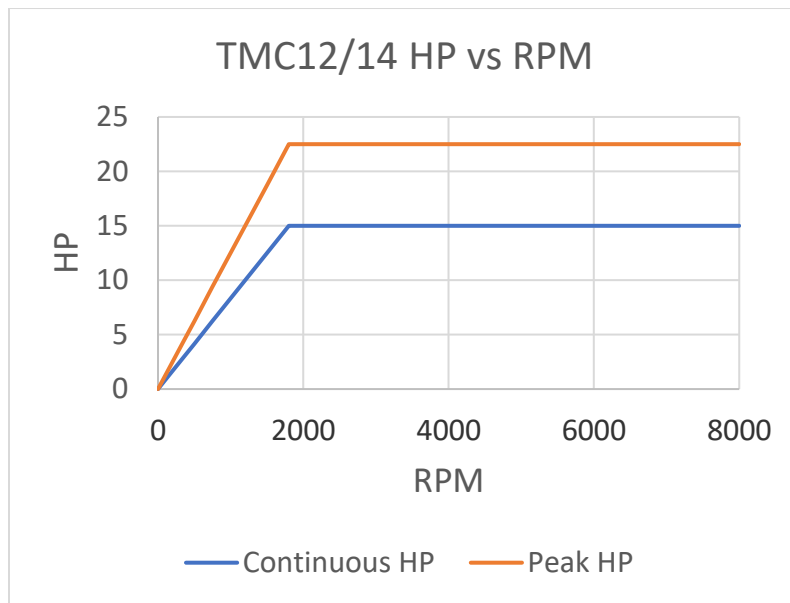

Figure 2.13.1d

Note - Maximum work capacities are dependent on a lot of variables that cannot be controlled by the machine manufacturer. Each one of the following will have an impact on the above numbers: speeds, feeds, cutter, cutter sharpness, material, setup, coolant and machine adjustments.

2.14 ProtoTRAK RMX Euclid Block Procedure

The test part should be machined at the completion of the installation.

The material for the Euclid block test part is found in the toolbox.

- Material Specification: Aluminum, 6061-T6 or T4
 - Blank Size: (minimum dimensions) 3 x 3 x 1", provided in tool box
 - Tool: .750 end mill, 2 flute, high speed steel, **sharp**
 - Coolant: Flood coolant, Cool-Tool or Kerosene
1. Mount vise and indicate the back jaw parallel to the table within .0005".
 2. Clamp material in vice with a minimum of .800" above the vise jaws.
 3. Load in the Euclid block program. It is found under the C drive, PROTOTRAK folder, and TMC INSPECTION PROGRAMS folder, click on EUCLID.PT10 to run and follow instructions.
 4. Use an edge finder to set Absolute 0 on X and Y. Absolute zero is the front left corner of the block as viewed from in front of the machine.
 5. Load the .750 end mill and set Z Absolute 0 at the top of the part, and set Z total length offset in the tool table.
 6. Begin to run the program. The part will be machined in the following sequence:

Event(s) #	Description	Depth of Cut
1	circle pocket – cuts middle circle	-0.250"
2	circle profile – cuts outer 1.830 diameter circle	-0.250"
3	circle profile – removes extra material outside of circle	-0.250"
4	milling event - removes extra material outside of triangle	-0.250"
5-12	irregular profile – cuts material from corners remaining on Euclid block and cuts triangle on Euclid block	-0.500"
13	rectangular frame – cuts outer 2.750" rectangle	-0.750"
14	position event – check for accuracy of circle	0.050"

7. After the program runs, the program will locate to the following position.
 - a. X = 1.318
 - b. Y = 1.318
8. Mount a dial indicator in the quill and check the circles using figure 2.14 as a reference.
9. Check the runout of the sides of the square frame.
10. Inspect the machined surfaces for smoothness.

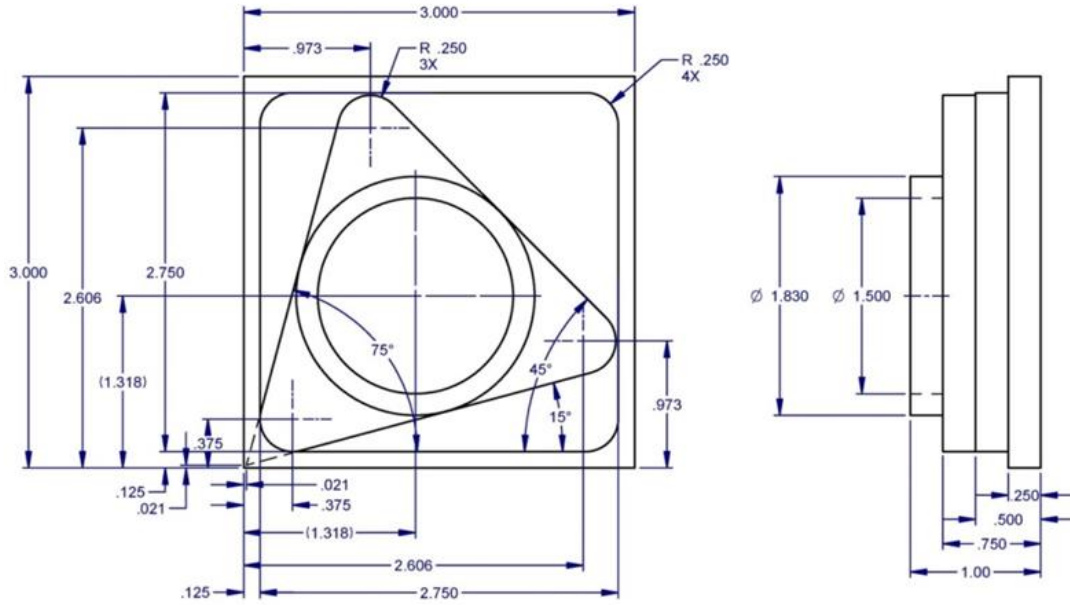

i15537-1

Figure 2.14

3.0 Troubleshooting by Symptom

Use this section to begin the process of resolving a service problem. Each symptom type is described in a few words and then more fully described in an explanatory paragraph. Following this is a chart that directs in the most logical steps.

FOR ADDITIONAL DETAILED TROUBLESHOOTING PROCEDURES, PLEASE VISIT OUR DOZUKI WEBSITE:

<https://trakmtsupport.dozuki.com/>

3.1 Problems Relating to Machining Results

3.1.1 Poor Finish

The part finish is marred with scallops or is very rough.

Do the following Service Codes and document values:

- **Code 33** - Software Identification. This is needed if you call SWI Customer Service
- **Code 128** - Enter backlash compensation
- **Code 134** - Friction Feed Forward

Possible Cause	Check This
Too much backlash entered for code 128.	Verify nothing is mechanically loose and the backlash values are not higher than what physically is in the system.
Friction feed forward set too high or low	Check the value of code 134 and adjust as required.
Machine Tool & Setup problem	Check for any looseness in the setup (Tool, Tool holder, Part, Vise, or Fixture). Check the condition and type of cutter being used, type of material, RPM and Feed rate, etc.
Inadequate or no Lubrication to Ballscrews and Linear Guide surfaces	Make sure all the Linear Guide surfaces are getting proper lubrication. If not, check to make sure that the lube pump is functioning properly. Also check for any pinched or blocked oil lines.
X & Y-axis Drive Trains are loose	Check Repeatability using the Repeatability and Positional Accuracy procedure. Step by step, carefully inspect the Drive Train for any looseness. It may be necessary to disassemble and then reassemble the Drive Train.
Linear Guide surfaces are scarred, exhibit noise or vibration, or are excessively worn	Visually check the condition of all the Linear Guide surfaces. For machines that may have excessively worn Linear Guide surfaces, a trained SWI Technician may need to inspect this area to determine if they need to be replaced. Check lubrication to affected areas.

3.1.2 Circles Out of Round

Circles are not round within 0.001" TIR over a 1.830" dia. This is best measured by placing a dial indicator in the spindle and sweeping around circle on the Euclid block part.

Do the following Service Codes and document values:

- **Code 33** Software Identification. This is needed if you call SWI Customer Service
- **Code 128** Enter backlash compensation
- **Code 134** – Friction Feed Forward

Possible Cause	Check This
Backlash values set too high or low	Check code 128. Typically values for backlash should be less than 0.0005". Reset values as necessary.
Friction feed forward set too high or low	Check the value of code 134 and adjust as required.
Machine Tool and Setup problem	Check for any looseness in the setup (Tool, Tool holder, Part, Vise, or Fixture). See Machine Tool & Setup
Machine not level	Verify that the machine is level to specification.
Head is not trammed	Verify that the Head is trammed to specification.
X & Y-axis Drive Trains are loose	Check Repeatability using the Repeatability and Positional Accuracy procedure. Step by step, carefully inspect the Drive Train for any looseness. It may be necessary to disassemble and then reassemble the Drive Train.

3.1.3 Parts Have Incorrect Dimensions

Parts are being machined with dimensions that are different than those programmed. Typical accuracy expectations should be:

- **Circles:** 0.001" TIR over a 1.830" DIA (assumes cutting Euclid block)
- **Positional Accuracy:** 0.0002"
- **Repeatability:** 0.0002"

Do the following Service Code:

- **Code 33** Software Identification. This is needed if you call SWI Customer Service
- **Code 123** Calibration
- **Code 128** Enter backlash compensation

3.1.3.1 Every Part Has the Same Error

Possible Cause	Check This
Machine Tool & Setup problem	Check and verify correct tools & setup.
Programming Error	In the program, look for common errors in programming such as transposing numbers, tool diameters, and pressing INC SET when ABS SET is meant. This is especially suspected if the dimensional errors are larger than a few thousandths. See the Controls Programming, Operations and Care manual.
Configuration file that contains calibration file that has been erased or corrupted.	Make sure there are values for calibration under service code 123. Default values would read all zero's which means the machine needs to be calibrated. A back up copy of the configuration will be available at SWI. We will need the machines serial number when you call us.

Possible Cause	Check This
Backlash problem	Unusual high backlash values are causing slight variations in your part dimensions. Values for backlash should be less than 0.0005".

3.1.3.2 The Dimensional Errors Are Random or Accumulate in Size Over the Part Program Run

Possible Cause	Check This
X and Y-axis Drive Trains are loose	Check Repeatability using the Repeatability and Positional Accuracy procedure. Step by step, carefully inspect the Drive Train for any looseness. It may be necessary to disassemble and then reassemble the Drive Train

3.2 Motion Related Problems

3.2.1 Run Away Axis

The axis makes an unwanted move at rapid speed in one direction and faults out. This is usually caused by an encoder signal being interrupted or following error building up on that axis. Following error is when the control sends a signal to the motor and the motor does not respond as it should. Once the error builds up to a certain point this will lead to a following error fault.

Do the following Service Codes:

- **Code 33** Software Identification. This is needed if you call SWI Customer Service

Possible Cause	Check This
Poor cable connection	Check the cable connections at the motor, computer module and servo amp
Bad Servo Amp	Check the status of LED lights on servo amp when problem occurs.
Bad Motor Encoder	Contact TRAK to arrange service.
Computer module	See section 5.1.2 to replace computer module.

3.2.2 Axis Will Not Jog with Electronic Handwheel

The system powers up but will not respond to the jog command using the electronic handwheel.

Do the following Service Codes and procedures:

- **Code 33** Software Identification. This is needed if you call SWI Customer Service
- **Code 132** Each revolution of the EHW should display 100 counts on the screen

Possible Cause	Check This
Software may be in an indeterminate state	Press the MODE button and reenter the same screen and see if EHW works.
E-Stop is pressed in	Check E-Stop. Make sure the servo ON button has been pressed to energize the servo system.
EHW has failed	Verify the wiring of the EHW and replace as necessary. If only 1 axis will not jog, then it is not the EHW.
Poor cable or wiring connections	See Electrical Sections 2.8.
Servo Drive failure	See Section 5.1.9
Motor failure	Contact TRAK for service.
Computer module failed	See section 5.1.2 to replace computer module.

3.2.3 Searching Axis

The DRO screen is flickering back and forth when the servos are engaged. Several ten thousandths of motion are observed and the frequency is one cycle every couple of seconds.

Do the following Service Code and procedures:

- **Code 128** Backlash compensation

Possible Cause	Check This
Most often caused by excess backlash compensation	Check physical backlash in system and re-enter in code 128.
Looseness or excessive friction in the drive train	The drive train of the axis that is searching, especially the tightness of the drive assembly.

3.2.4 Homing Error – Axis, Tool Changer

The homing function is a very critical function that locates and identifies the absolute machine zero position, where all other positions and offset are derived from. This function is to be performed every time the system has been turned on or reset. The homing function will cause the tool changer to move to tool position one, it will also cause each axis to move in the most positive direction that it can.

Do the following Service Code and procedures:

- **Code 505** Overtravel Soft Limits

Possible Cause	Check This
Door is open.	If the Door is open the tool changer will not turn, a "Door Error" should be displayed.
Wiring problem with tool changer.	Verify that the tool changer wiring is correct.
Tool changer in or out failure. Note the tool changer should be in the out position when homing.	Contact TRAK for service
Tool changer will not rotate. Note the tool changer should home to where tool position 1 is facing toward the spindle.	Contact TRAK for Service
Home Switch failure.	Contact TRAK for Service
Servo Drive failure	See Servo Driver replacement, Section 5.1.9.
Motor failure	Contact TRAK for Service
Computer Module failure	Contact TRAK for Service

3.3 Computer Related Issues

3.3.1 USB Not Working on Pendant Enclosure

When plugging in a USB device the control does not recognize it. Service Code 540 may be needed depending upon repairs needed.

- **Code 540** Disable File-Based Write Filter

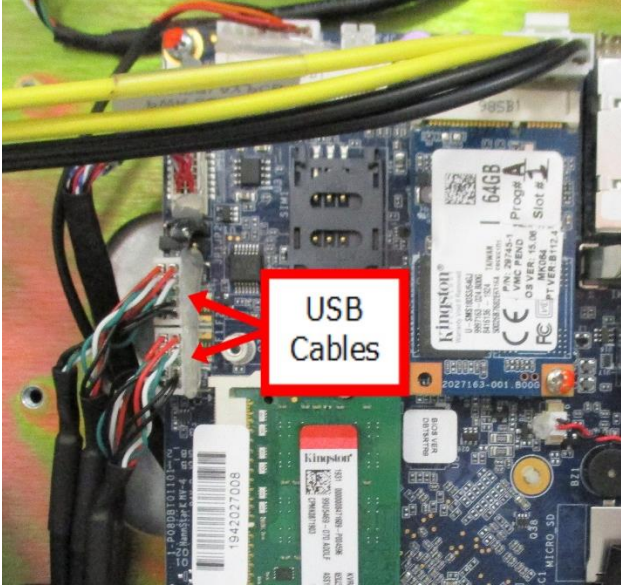
Possible Cause	Check This
USB drive not working	Verify USB works on known good PC, replace USB drive if it failed.
Device driver not loaded on control	Device driver may not be installed for USB device or be corrupted. Run service code 540 and load USB driver.
Poor USB cable connections	<p>Check different USB port. If good problem with previous USB port. Check cable from bad USB to computer board following cable from USB to computer connections as shown on the photo. Make sure both cables are properly seated. Check all USB ports.</p> 
All USB drives not working	Motherboard problem, contact TRAK for service to replace programming panel.

3.3.2 Programming Panel Does Not Power On

When you see this symptom, we need to make sure power is getting to the programming panel from the computer module.

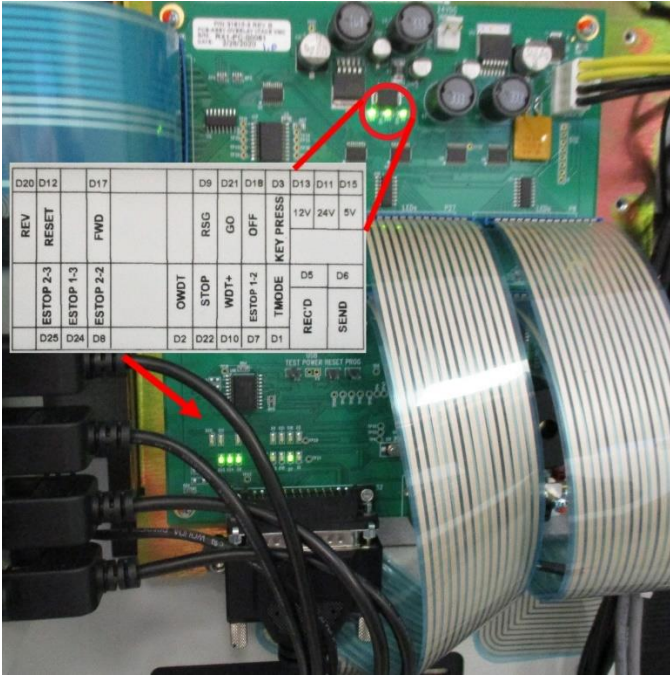
Possible Cause	Check This																																												
Poor Cable Connections	Verify the DB25 pin connector and Computer Module Ethernet cables are connected.																																												
Power not getting to programming panel	<p>Verify 24 VDC is making it to the programming panel enclosure. Remove programming panel rear cover leaving the two screws at the top for easy removal. Check LEDs on the inside of the programming panel enclosure as shown below. If no LEDs are on, then the computer likely has no power. Make sure the computer module is getting power.</p>  <table border="1" data-bbox="734 808 1088 997"> <tr> <td>D20</td> <td>D12</td> <td>D17</td> <td></td> <td>D9</td> <td>D21</td> <td>D18</td> <td>D3</td> <td>D13</td> <td>D11</td> <td>D15</td> </tr> <tr> <td>REV</td> <td>RESET</td> <td>FWD</td> <td></td> <td>RSG</td> <td>GO</td> <td>OFF</td> <td>KEY PRESS</td> <td>12V</td> <td>24V</td> <td>5V</td> </tr> <tr> <td>ESTOP 2-3</td> <td>ESTOP 1-3</td> <td>ESTOP 2-2</td> <td></td> <td>OWDT</td> <td>STOP</td> <td>WDT+</td> <td>TMODE</td> <td>D5</td> <td>D6</td> <td></td> </tr> <tr> <td>D25</td> <td>D24</td> <td>D8</td> <td>D2</td> <td>D22</td> <td>D10</td> <td>D7</td> <td>D1</td> <td>REC'D</td> <td>SEND</td> <td></td> </tr> </table>	D20	D12	D17		D9	D21	D18	D3	D13	D11	D15	REV	RESET	FWD		RSG	GO	OFF	KEY PRESS	12V	24V	5V	ESTOP 2-3	ESTOP 1-3	ESTOP 2-2		OWDT	STOP	WDT+	TMODE	D5	D6		D25	D24	D8	D2	D22	D10	D7	D1	REC'D	SEND	
D20	D12	D17		D9	D21	D18	D3	D13	D11	D15																																			
REV	RESET	FWD		RSG	GO	OFF	KEY PRESS	12V	24V	5V																																			
ESTOP 2-3	ESTOP 1-3	ESTOP 2-2		OWDT	STOP	WDT+	TMODE	D5	D6																																				
D25	D24	D8	D2	D22	D10	D7	D1	REC'D	SEND																																				
Motherboard failure	<p>If 24 volts reaches the programming panel enclosure, then verify the 12 VDC and 5 VDC LEDs are on. If they are on, there is a failure in the motherboard. Check connections. If they are good, replace programming panel.</p>																																												

3.3.3 Blank Display

TMC seems to be operational; however, the display is blank.

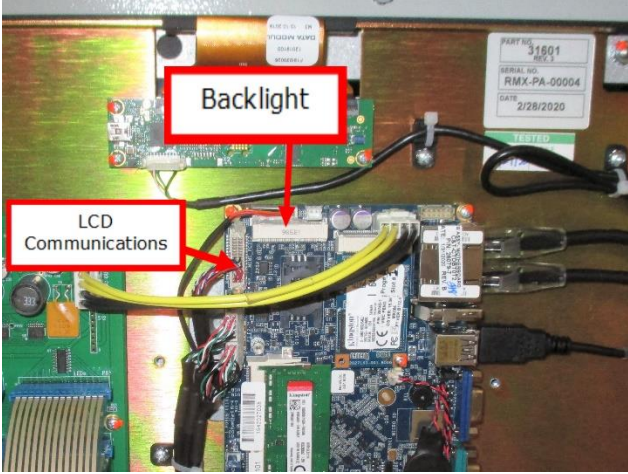
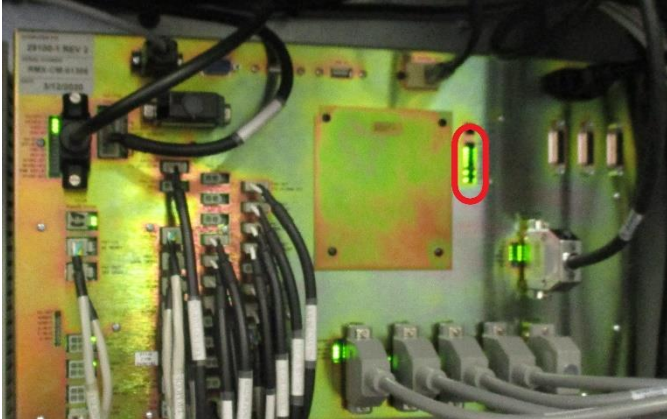
Possible Cause	Check This
Electronics did not power on properly.	Reboot TMC by turning off power, reapply power and see if problem goes away.
Cable connections loose	<p>Check for working LEDs on run panel, if working press keys on programming panel. Should hear a beep, if not working check two cables (backlight and LCD comm cables) as shown:</p> 
Failure on programming panel	Replace programming panel.
Power is not getting to programming panel	<p>Check for working LEDs on run panel. If LEDs not working, move to electric cabinet and check power cord is plugged into the panel. Then verify LEDs are working in such as: 24V, 5V, 3.3V, and 1.2V as shown below. The 24V is the most important to make sure it is working. If not working, replace computer module.</p> 

3.3.4 White Display

TMC has a white display.

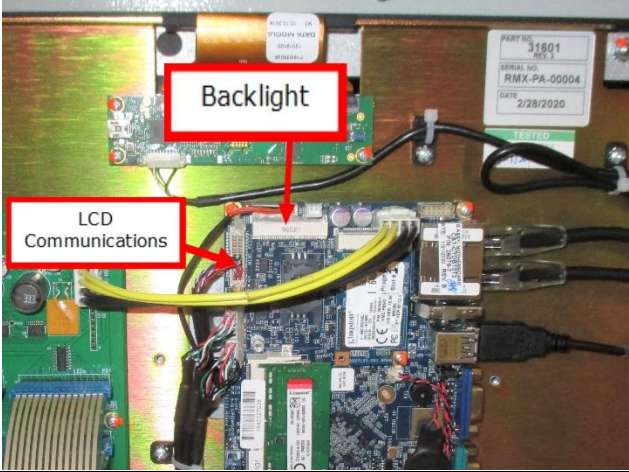
Possible Cause	Check This
Possible LCD Communication cable connection failure	Verify the LCD Communication cable is connected correctly as shown: 
Failure on Programming Panel	Replace programming panel.



3.3.5 System Will Not Boot

TMC will not boot up. TMC has power, run panel and programming panel are operational. There is text on the screen again a black background. (A flashlight might help to see the reflection of the text on the black screen.)

Possible Cause	Check This
Boot process failed on motherboard	EFI Shell Error displayed on screen, power off TMC, restart and see if control boots up.
Poor connection of MSATA drive to motherboard	Verify MSATA Drive is attached correctly and single screw is in place as shown below: 
Motherboard failure	Replace Programming Panel.

3.3.6 E-Stop Error

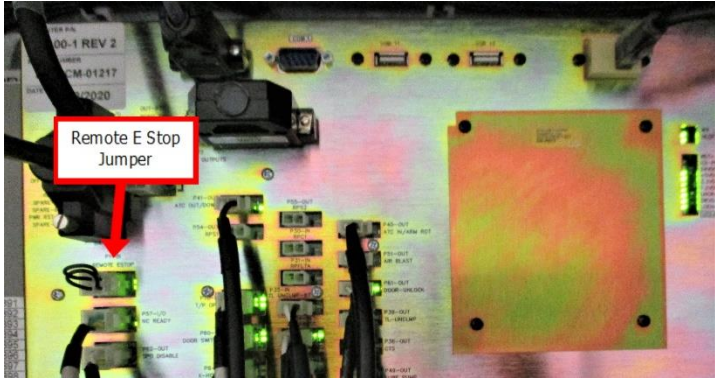
The Warning button is flashing and has an E-stop message, error code 261. It will not allow the machine to be moved around.

Possible Cause	Check This
Make sure E-Stop switch is out and not pressed	Clear message and make sure Power Reset button is turned on. If problem persists reboot control and see if message goes away.
Jumper may have come loose	Check removable jumper is in place and connected properly as shown below:  If connected, restart TMC.
Computer module internal failure	Make sure both E Stop jumper lights are on. If either is off, computer module failure, call TRAK for service. If both are on, more to next step.
Computer module internal failure	Check E-Stop lights in electric cabinet, make sure 2 LEDs are on as shown below:  Either light off, computer module failure, call TRAK. If both are on, move to next step.

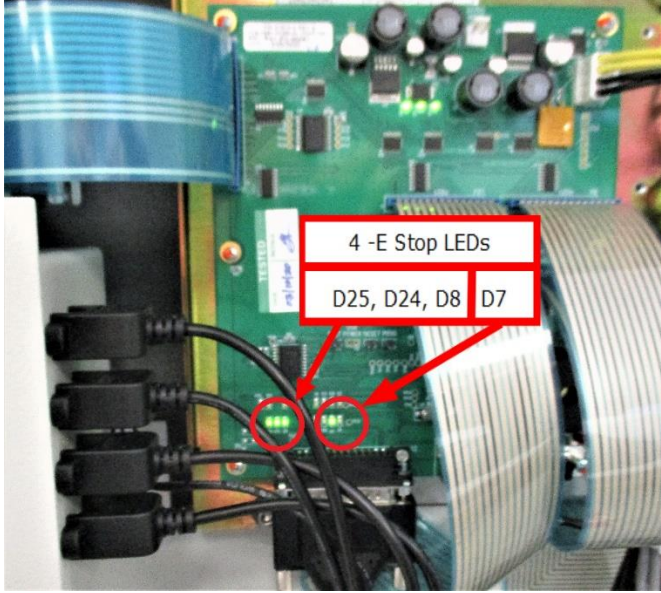
Possible Cause	Check This
LED lights on overlay interface board on programming panel are off.	<p>Check E-Stop 4 LEDs on the programming panel overlay interface board as shown below:</p>  <p>If any of the lights are off, check RS232 cable to electric cabinet. If the connection is good, programming panel likely needs to be replaced.</p>
Faulty E Stop switch or wiring	Check E Stop switch inside pendant and its cable to circuit board for connections on both ends. If hardware problem, replace parts, otherwise run panel problem. Call TRAK for service.

3.3.7 Overlay Keys Not Responding

Keys from any section of the Programming or Run Panels are not responding. Do the following Service Code and procedures.

- **Code 81** Front Panel Keyboard Test

Possible Cause	Check This
Control did not recognize the correct product model	Run Service Code 81 and verify that the screen displays the same key panels as the TMC. If wrong key panels, reboot and retest Code 81. If problem persists, call customer service.

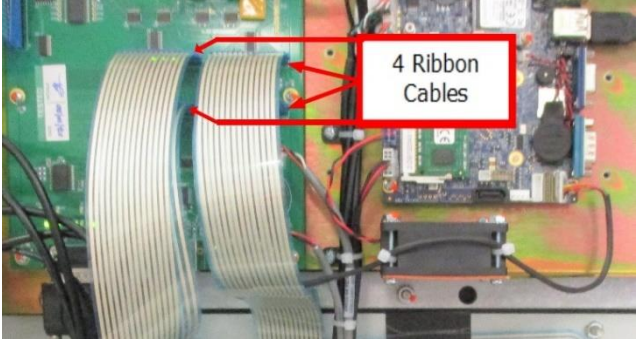
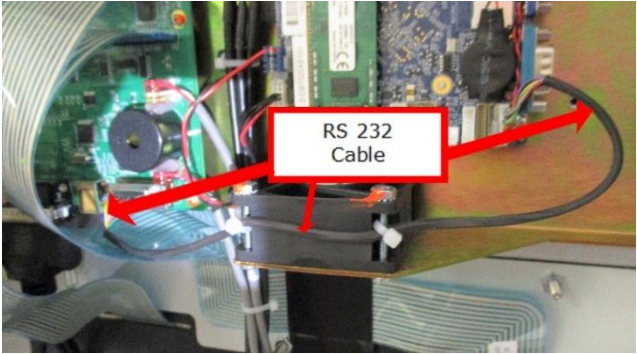
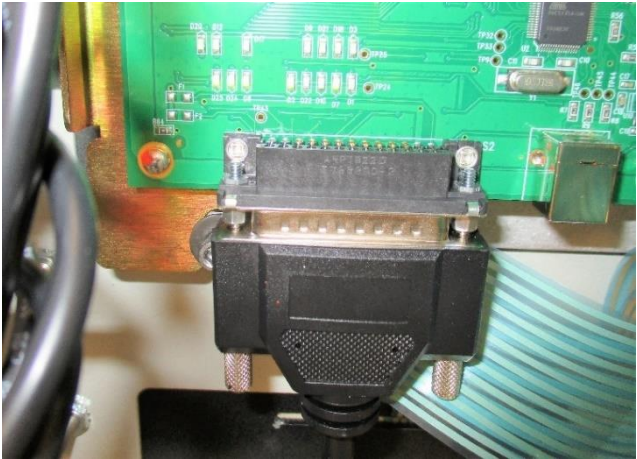
Possible Cause	Check This
Keys work but erratic, some work, some don't	<p>Open the rear panel and check to make sure all 4 ribbon cables are tight and seated correctly as shown:</p>  <p>If they are, call TRAK customer service. Likely need programming panel replacement.</p>
No keys work at all	<p>Check 4 ribbon cables shown above and RS232 cable from overlay PCB to motherboard are seated as shown:</p>  <p>If RS 232 seated correctly, call TRAK customer service.</p>
Connection problem with DB25 cable	<p>These are critical keys and can be checked by running Code 81. If problem, check ribbon cables in step 2 as well as DB25 cable on lower left of programming panel as shown:</p>  <p>Likely programming panel problem. Call TRAK Customer Service.</p>

4.0 Automatic Tool Changer Operation and Service Codes

4.1 Tool Changer Operation

The Automatic Tool Changer or the ATC, as it is referred to throughout this manual, consists of two major assemblies, the ATC Assembly, Upper and the ATC Assembly, Lower.

The ATC Assembly, Upper is responsible for the ATC movement toward the spindle (In) as well as the movement away from the spindle (Out). This movement is achieved by the means of a double acting pneumatic (air) cylinder. The ATC's movements In and Out are also cushioned at the end of travel by means of hydraulic cushioning cylinder.

The ATC Assembly, Lower is responsible for the ATC indexing from tool location to tool location by means of a Geneva mechanism, which consists of an indexing carousel, an indexing pin, a locking segment and a geared indexing motor.

4.2 Spindle Orientation

An automatic tool change requires that many components of the TMC work in concert with one another. These components include the ATC (Position relative to the centerline of the spindle), the spindle (Orientation of the spindle drive dogs relative to angle of the tool holder held in the ATC), the Z-axis (tool change height) and the Automatic Draw Bar (being in state of clamped or unclamped).

Let's start with spindle orientation. Spindle orientation is like any other setting regarding the ATC, it is a critical one, as a crash would be the result of an improper setting. Spindle orientation centers the drive dogs of the spindle for proper engagement of the CAT40 tool holder when it is held in the tool carousel of the ATC. Service code 510 will safely walk you through this procedure. Make sure to follow the procedure precisely.

4.3 Tool Change Height

Service code 501 will take you through the procedure for setting the tool change height. This will set the position where the Z-axis will clamp or unclamp the tool by the automatic draw bar. Like the spindle orientation, this setting is also critical.

During this procedure you will hear the "air through the spindle", this is not a nuisance, but rather a valuable tool for this procedure. As you near the proper tool change height while performing service code 501, you will hear the sound of the air slowly being blocked off, simply creep down at .010" jog feed rate until the sound of the air just disappears, then back it off one click and the slight sound of air will once again be heard. That is the proper tool change height.

It should be noted, that the tool clamping mechanism will give the CAT40 tool holder a slight bump at "Unclamp", to dislodge the tool holder from the spindle. Likewise, it will give the tool holder a slight tug at "Clamp". This action is both normal and proper.

Any improper setting of the tool change height would result in unnecessary stresses on the gripper assemblies and the tool carousel.

4.4 Tool Changer Sensors

The automatic tool changer as a system has seven limit switches and/or sensors that monitor its state:

- ATC Home Position Sensor (proximity switch)
- ATC Count Sensor (proximity switch)
- ATC Tool Detect Sensor (optical)
- ATC "In" (limit switch)
- ATC "Out" (limit switch)
- Tool "Unclamp" (limit switch) Found on milling head
- Tool "Clamp" (limit switch) Found on milling head

4.4.1 ATC Home Position Sensor

Is used to tell the control where home is location as shown in figure 4.4.1. During the Homing sequence, the carousel will continue to index in the clockwise direction until the home position stud is detected. If for some reason the stud is not detected, the ATC will simply "time out". At which point it must be determined whether or not the sensor is functioning or not.

At the pendent, index the tool changer until it is in the home position. Run service code F to determine whether or not the sensor is detecting the home position stud.

If it is determined that the stud is not being detected, press the E-Stop and place a steel object, such as a screw driver beneath the sensor and see if the amber LED illuminates. If not, the sensor is either not receiving power, is faulty or the home position stud is not properly set.

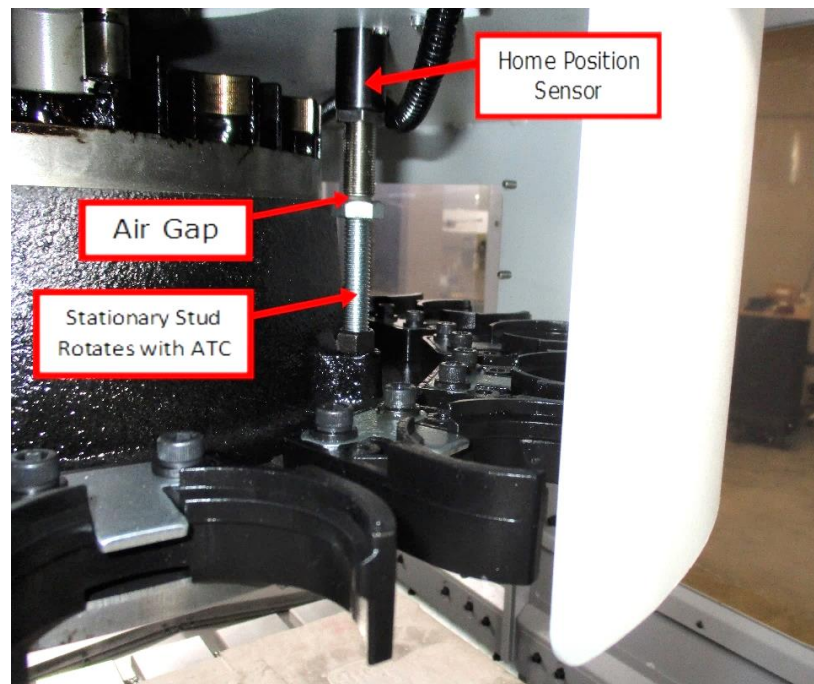

Figure 4.4.1

4.4.2 ATC Counter Sensor

Consists of a proximity switch, and cam with a window. One rotation of the cam represents one station index. When the cam is in the home position, the proximity switch recognizes it and illuminates an amber LED. Once the cam has rotated and the sensor recognizes the window, the logic waits for the cam to once again be recognized. Once recognized, a timer begins, and for a calculated amount of time, the motor continues to drive until home position is reached. It is critical that the cam be oriented as shown in figure 4.4.2. This puts the locking segment in the optimum position. The sensor should be positioned in the center of black bracket you see in figure 4.4.2. It is critical to keep this mechanism clean for trouble free operation.

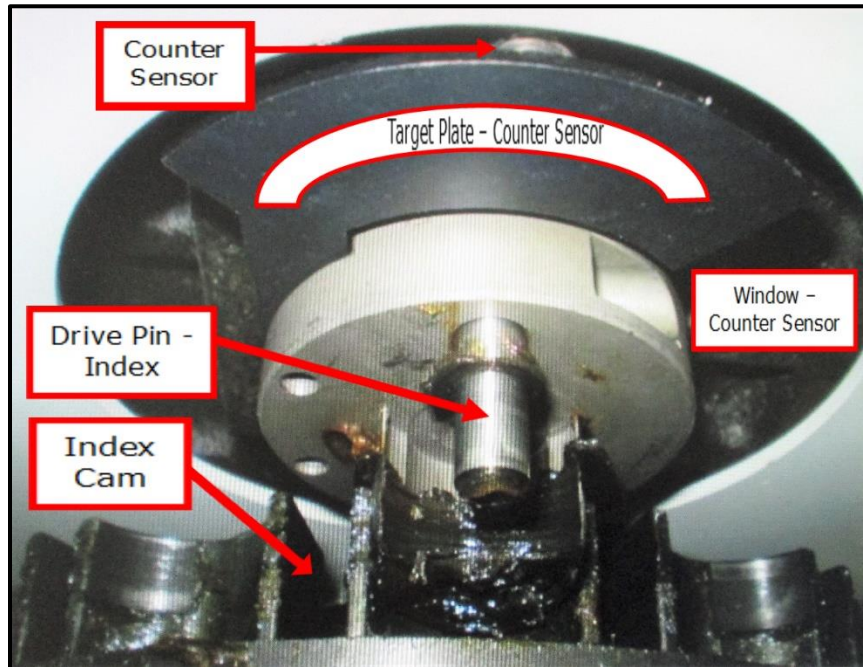

Figure 4.4.2

4.4.3 ATC Tool Detect Sensor

The tool detect sensor is used as the name suggests, to detect whether a tool is present in the tool carousel at the tool change position. If a tool change was attempted with a tool in the spindle and in the tool change position in the carousel a crash would occur.

If the tool detect sensor detects a tool that is not present, check the sensor lens for contamination. Debris on the lens can cause a false detection of a tool.

The Tool detect sensor is an optical type sensor, it sends out a "fan" beam that can set as vertical, horizontal or anywhere in between. The sensor must be set to send out a vertical beam.

Failure to do so runs the risk of the sensor picking up parts of the tool changer other than the tool holder itself. The tool detect sensor uses LED's that change color, green LED indicates no tool is present, and orange LED indicates that a tool is present. These LED's can be found on the underside of the barrel of the tool detect sensor when it is mounted properly. The front of the sensor should be mounted approximately one inch from the sensor bracket. To set the intensity of the tool detect sensor start with a tool in the carousel in front of the sensor, adjust the pot on the sensor counterclockwise until the LED

turns green which means no tool detected, then turn the pot clockwise until the LED just turns orange then continue clockwise no more than 1/8 of a turn. The sensor LED should be orange. Now test the adjustment by commanding the carousel to rotate 1 position to either side of tool change position to verify the sensor sees the tool when it is in tool change position and it doesn't see the tool when it is not in tool change position. See figures 4.4.3a and 4.4.3b. See section 6.2 for replacement instructions.

The angle of the tool detects sensor bracket (20°) is designed to cast a beam that is as perpendicular as possible to the angle of the tapered shank of the CAT40 tool holder.

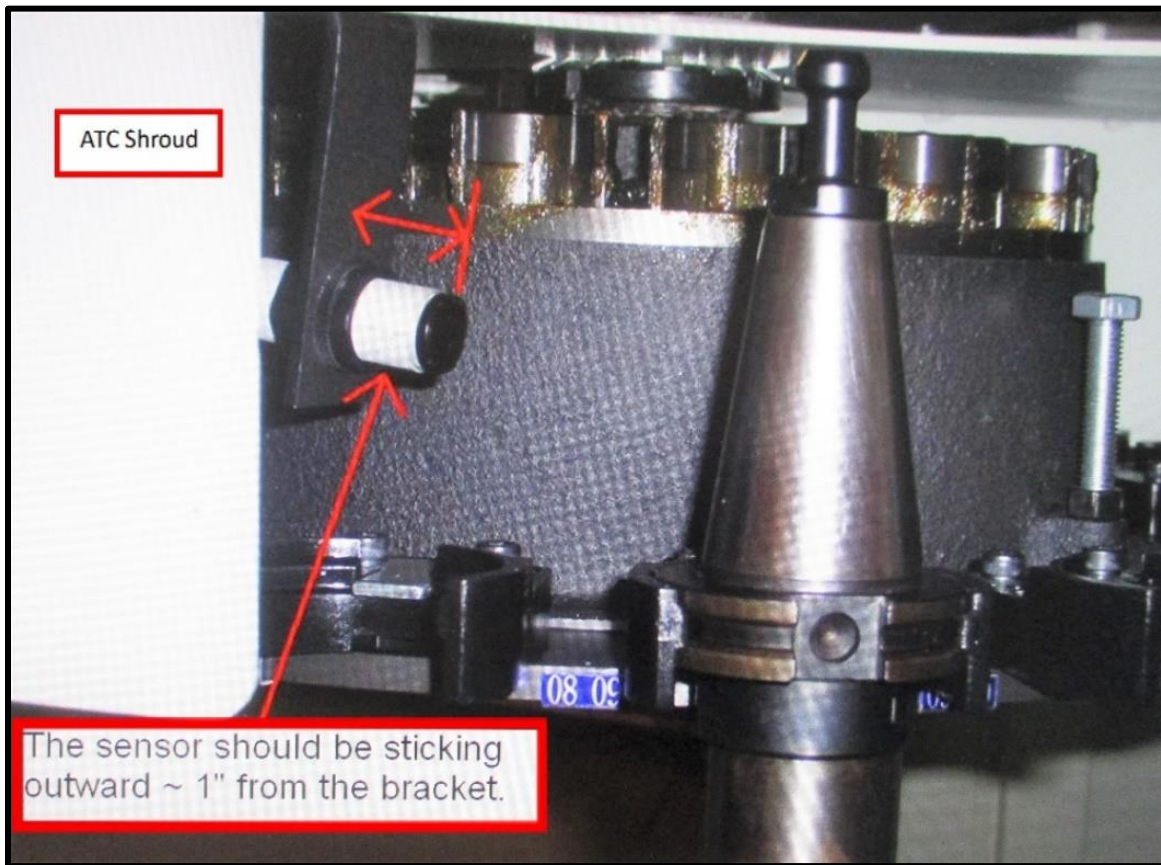

Figure 4.4.3a

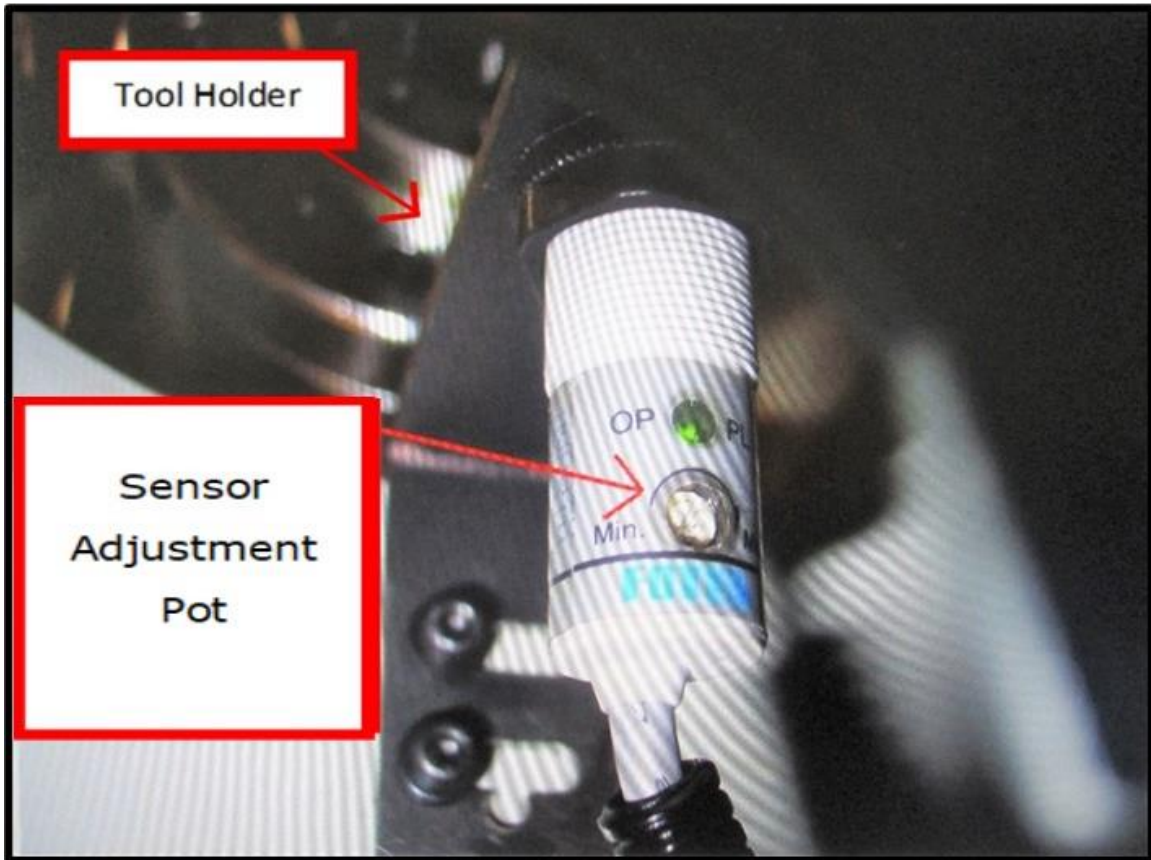

Figure 4.4.3b

4.4.4 ATC "In"

Is a limit switch that detects that the ATC has advanced all the way forward to the spindle.

4.4.5 ATC "Out"

Is a limit switch that detects that the ATC has retracted all the way back from the spindle.

4.4.6 Tool "Unclamp"

Is a limit switch that detects that the tool unclamp mechanism is in the unclamped state. If this limit switch is not set or functioning properly, there is the potential that the draw bar could get friction welded to the air cylinder adjusting screw. This switch is triggered only when you are physically loading a tool in and out of the spindle. Pressing the green button on the head puts the machine in this state.

4.4.7 Tool "Clamp"

Is a limit switch that detects that the tool clamp mechanism is in the clamped state.

4.5 ATC Flow Control Valves

The speed at which the ATC can move inward or outward can be controlled by the flow control valves. The flow control valve on the left controls the speed at which the ATC travels inward. The flow control valve on the right controls the speed at which the ATC travels outward. In the case of either valve, an adjustment in the clockwise direction reduces the speed of the ATC sliding assembly, and an adjustment in the counter clockwise direction increases the speed of the ATC sliding assembly.

4.6 Error Messages Relating to the ATC

The following is the list of error messages that the ATC might generate:

Error Number	Error Message
124	The spindle did not orient correctly. Please use service code 510 to double check that the spindle is orientating to the correct position vs the position that's commanded.
126	The spindle is in the unclamped position and needs to be clamped to proceed. The unclamp limit switch is detecting that the tool clamping mechanism is still in the unclamped state, this might occur when a tool is being called, but it is not clamped in the spindle. In this state if the ATC was to move, the tool could be dropped on the table.
127	The spindle is in the clamped position and needs to be unclamped to proceed. The clamp limit switch is detecting that the tool clamping mechanism is still in the clamped state, this might occur when a tool has been returned to the tool carousel, but is still clamped in the spindle. In this state if the Z axis was to move, the tool gripper in the ATC could be damaged.
128	The ATC carousel was unable to find its home position. This likely occurs if the home position sensor is not functioning properly, or the home position stud is not set properly. See Section 4.4.1
129	The ATC IN vs OUT location has become unknown, and you must use code 513 to re-home the ATC. If problem persists, check that air pressure is available and ATC limit switches are functioning properly.
130	The ATC carousel is unable to rotate position because of some obstruction or Z axis position error. If you were mid tool change when this error occurred, then use service code 513 to reset the ATC.
131	The ATC timed-out moving IN to the tool change location. Check air pressure and the ATC limit switch functionality. If you were mid tool change when this error occurred, then use code 513 to reset the ATC.
137	The ATC is unable to move in because there is currently a tool in the spindle and one in the carousel location. This message appears whenever the tool detect sensor detects that there is a tool in a location of the tool carousel where the tool in the spindle is being commanded to call or return.
138	The ATC is trying to unclamp the spindle but the spindle is still in motion. This message appears when the system detects any amount of velocity from the spindle. The system will not allow the spindle to unclamp under this condition.
139	The ATC carrier is trying to move but the air pressure is too low. Check air pressure and make sure it is set to the correct amount. If you were mid tool change when this error occurred, then use service code 513 to reset the ATC.
143	The ATC carousel received a false trigger from the counter sensor. Check that the counter sensor is clean of debris, then try re-homing the ATC using service code 513. See Section 4.4.2
144	The ATC counter sensor is detecting that the carousel is not in location properly. Please use code 513 to reset the ATC. If problem persists, check that the carousel is in location properly, and that the ATC counter sensor is functioning properly. See Section 4.4.2
150	System has timed out waiting for the ATC Counter Sensor to change state. Confirm that ATC Carousel is moving. Then check to make sure that the ATC Counter Sensor is free of any oil or debris and retry. Use code 513 to reset the ATC. See Section 4.4.2

Error Number	Error Message
208	ATC limit switch failure. Both ATC IN and OUT limit switches are active. Check that both ATC limit switches are functioning properly. If ATC was mid tool change when this error occurs, then use service code 513 to reset the ATC.
218	The ATC timed out moving OUT to the stored location. Check the air pressure and the ATC limit switches. If ATC was mid tool change when this error occurs, then use service code 513 to reset the ATC.

4.7 Diagnostics Table

There are two types of motion we discuss regarding the automatic tool changer, the inward and outward motion of the tool changer sliding assembly, and the rotational movement of the tooling carousel. The following table will attempt to simplify problem diagnosis:

Symptom	Possible Cause	Remedy
ATC will not advance towards the spindle.	<ul style="list-style-type: none"> The front sliding door is open Compressed air is not being supplied to the machine. The in-line air switch is in the closed position Low air pressure The solenoid is not receiving an electrical signal. Is the solenoid LED illuminated? The blue polyurethane tube supplying air to advance the sliding mechanism toward the spindle became pinched or obstructed. An obstruction is preventing movement. 	<ul style="list-style-type: none"> Close the door or defeat the safety interlock limit switch. Supply 90 psi air to the machine Make certain the in-line air switch is in the open position (upward) please refer to pneumatic assembly drawing 26930 found at the rear of this manual. Find the cause of the low air pressure. Pressure should be 90 psi at the machine's regulator. Check that the solenoid has not been manually over ridden. Replace and re-route pinched tubing. Remove the obstruction
ATC will not retract away from the spindle	Automatic Draw Bar has failed to release the tool from the spindle	Re-set the air gap between the automatic draw bar actuator, and the automatic draw bar (5mm)
The ATC is commanded "In", however, the ATC advances towards the spindle, pauses then retracts on its own.	<ul style="list-style-type: none"> The ATC "IN" limit switch is not being recognized. Air pressure is too low Low air pressure sensor is not set or functioning properly The ATC "IN" limit switch is not functioning properly 	<ul style="list-style-type: none"> Remove the obstruction that is preventing the ATC from reaching the limit switch Check the system air pressure at the regulator, it should read 90 psi Check the Low air pressure sensor, it is set at the factory to trigger at 60 psi Replace the ATC "IN" limit switch

Symptom	Possible Cause	Remedy
ATC carousel fails to find HOME	Home position sensor is not set or functioning properly.	Manually index ATC carousel until the Home Position Stud is aligned with the Home Position Sensor. Adjust the Home Position Stud toward the sensor until the sensor is recognized. The LED will illuminate if the sensor is functioning properly.
ATC carousel fails to index	<ul style="list-style-type: none"> There is an obstruction in the Geneva mechanism The indexing pin has been broken 	<ul style="list-style-type: none"> Check for a heavy chip or other debris that is prohibiting the indexing pin from entering the Geneva plate (the ATC motor overload relay would be tripped under this condition). Find the cause of the breakage and then replace the pin
The tool holder "pops" when being removed from the spindle	Tool holder or the spindle bore taper is contaminated with dry coolant causing it to be tacky	Clean all mating surfaces
Tool holder falls from the spindle during a tool change	<ul style="list-style-type: none"> The wrong retention knob is being used. The pull fingers inside the spindle are damaged or missing 	<ul style="list-style-type: none"> Locate and use the proper retention knob. Visually inspect the pull fingers.

4.8 Service Codes

These are the most commonly used service codes for the TRAK TMC's.

Service codes are broken down into the following categories: software, machine setup, diagnostics, user options/defaults, lube pump, and I/O testing.

All Service Codes are accessed in the SET-UP Mode by pressing the soft key for "SERV CODES". The service codes can be found under one of the headings listed on the main screen. Press the heading you want to access the code in question. If you know code # you want, press the CODE # softkey and it will take you directly to the code in question. Press CODE #, enter the number you want, then press SET.

Warning!

Certain service codes must be performed when servicing certain items on the TMC. Failure to do so can lead to machine crashes and expensive repair work.

Do not work on the TRAK TMC unless you have been trained on these service codes.

Please see a table at the end of the service code section for the list of service codes that must be run when certain machine components are worked on.

The Service Codes are divided into logical categories. The table below is a quick summary of the service codes. More detailed information can be found below:

Software Services Codes		
Code	Description	Comment
33	Software, Firmware and PLC versions	Displays current software versions, master and slave operating system versions, machine ID key and software option versions.
141	Load configuration file from USB thumb drive	To load configuration files from a USB thumb drive to the RX control.
142	Save configuration file to USB thumb drive	To save the configuration files for reloading later. When a computer replacement (Section 5.1.2) is necessary, saving the settings to a thumb drive for reloading them later is highly desirable.
316	Update Software	Runs the routine that copies new software from a USB thumb drive device to the ProtoTRAK system. Use this routine to install new ProtoTRAK software.
318	Activate Converter	Displays which software options are turned on. Options in bold letters mean the option is active.

Machine Set-Up Service Codes		
Code	Description	Comment
123	Calibration Mode	Use to laser calibrate the RX control
128	Backlash Calibration Constant	Use to load backlash compensation for each axis.
134	Friction Feed Forward Constant	Compensates for friction variance from machine to machine
308	Reverse EHW Direction	Change movement direction of EHW
311	Run machine with spindle off	Disables spindle
400	Load foreign language MLS files	Used to download language tables that have been translated into a foreign language.
501	Set Z Tool Change Height	Used to enter the offset for the tool changer height relative to the Z home position.
505	Over-travel Limits	Used to setup and troubleshoot software limits.
510	Spindle Setup	Used to calibrate spindle, orient the spindle in relation to the ATC, and troubleshoot any spindle encoder related issues.
513	Reset ATC	Return Auto Tool Changer to initial position pointing to tool #1
530	Serial Numbers	Display serial numbers of major TMC components
540	Disable File Based Write Filter	Enable is default. Disable allows changes to Windows system settings (i.e. network or driver changes). Note - Save any programs in memory, this command forces a system reboot.

Diagnostic Service Codes		
Code	Description	Comment
1	Program, file, log, backup	Stores a file to flash drive documenting TMC operations for debugging uses
54	Continuous Run Mode	Cycles through the program in current memory.
81	Program Panel Keyboard Test	Gives a tone feedback to a button push and highlights the button.
131	Manual DRO	Turns off servo's so you can check encoders
132	Electronic Handwheel Test	Test the EHW signals
314	Toggle Test Lights in Status Line	Used to troubleshoot control issues
319	Error Logging	Logs the machine as it runs
320	Fault Log	Error log access
326	Error Message Display	Displays error messages on screen
327	Display Memory Check	Displays memory availability of various devices
521	Check Control/Indexer IO	Launches application to test all system I/Os
522	Diagnostic Charting Tool	Diagnostic used for plotting various inputs

Operator Defaults/Options Service Codes		
Code	Description	Comment
79	Turn On Beeper	Turn the beeper on when pressing keys on either of the front panels
328	EPA On/Off	Enables/Disable EPA section
600	Manager User Profiles	Allows user to define multiple user profiles for machinists accessed in DEFAULTS section

Lube Pump Setup Service Codes		
Code	Description	Comment
300	Lube Pump Switch Discharge	Allows the user to manual discharge the lube pump
301	Set Lube Pump Cycle Time	Sets the time in minutes between pumping cycles
302	Set Lube Pump Discharge Time	Sets the time in seconds for how long to pump for each cycle.

4.8.1 Section A - Software Code Details

The following codes pertain to software functions in the control. To get to any of these codes go to Service Codes, press "A" and press the code you wish to view.

Note - If you are working with the SWI Customer Service Group, write the values down for Code 33. These values will be valuable for troubleshooting.

4.8.1.1 Code 33: Software ID

The Code 33 is the software identification procedure. This will most likely be used when a customer service representative asks to identify what version(s) of software is being run on your machine.

4.8.1.2 Code 141: Load Configuration File from USB Flash Drive

This code allows you to load your configuration file from a USB flash drive to your machine's compact flash drive. The configuration file consists of items such as calibration, backlash constants, ball lock locations, base tool length and tool changer height. This code is useful when a computer module or compact flash card has been replaced, and you want to restore a machine to its previous state.

In order to load the files correctly on the TMC, you must have the file name will be of the format "RMX Configuration Machine ID" where machine ID is the number of the TMC.

4.8.1.3 Code 142: Save Configuration File to USB Flash Drive

This code allows you to save your configuration file to a USB flash drive. The configuration file consists of items such as calibration, backlash constants, ball lock locations, base tool length and tool changer height. This code is used when a computer module or compact flash card needs to be replaced. This stores the configuration file from the machine's compact flash drive to a portable USB flash drive. It is a good idea to do this code after the machine is initially setup so these values can be saved and used in the future. If the computer or compact flash card fails, then you will not have the ability to save the configuration file and the machine will need to be re-setup when the computer or compact flash drive is replaced.

4.8.1.4 Code 316: Update Software

Insert the USB flash drive that contains the software update and press this service code. New software will automatically download and the control may need to be shut down if prompted.

4.8.1.5 Code 318: Activate Converters or Options

This service code will allow you to check the status of, or activate any available converter or option for the machine.

4.8.2 Section B - Machine Set-Up Code Details

The following codes are used primarily when setting up a new machine. To get to any of these codes go to Service Codes, press "B" and press the code you wish to view.

4.8.2.1 Code 123: Calibration

See Section 5.3 for a further explanation of this code.

4.8.2.2 Code 128: Input Backlash Constant

Code 128 allows you to enter the backlash values for each axis. It displays the value after it is entered.

4.8.2.3 Code 134: Friction Feed Forward Constant

This is a tuning parameter for adjusting the machine's friction characteristics. It is set at the factory by running a ballbar plot using a measurement probe device, such as one made by Renishaw, and adjusted to obtain minimal error. It is not recommended to change the values unless told to do so by a service representative.

4.8.2.4 Code 400: Update Foreign Language MLS Files

If you have received a foreign language update for your machine, you can put it on a USB flash drive, and enter this service code to update your control.

4.8.2.5 Code 501: Set Z Tool Change Height

Sets the location, relative to home, where the Z axis will change its tools for the Automatic Tool Changer. This will need to be set if the Z motor or Z ballscrew is ever replaced. Major changes to the Z limit switches or limit switch cams may also require this. See service code screen for instructions.

4.8.2.6 Code 505: Over Travel Limits

When entering this service code, both the soft limits will be disabled so as to allow for setup or troubleshooting. If a soft limit is triggered, it will stop the motor from moving any further, but will not fault out or kill power to the motor.

In addition to the DRO, the motor index angle for each axis relative to the limit switch can be seen. This is to ensure that the index pulse for the motor is close to 180 degrees when it hits the limit switch. This is done to obtain maximum reliability when the machine performs its homing routine. The angle should be 180 degrees +/- 45 degrees. Values from 135 to 225 degrees are acceptable. Failure to set this correctly may cause the machine to not home properly which can lead to major problems.

1. **SOFT LIMIT ON / OFF** – You can choose to toggle the soft limits on or off. They will default to off when entering this service code, but will always turn back on after exiting.
2. In order to find the index angle, you manually select the desired axis and then carefully move it using the handwheel. When the home switch banner lights up on the screen you are able to view the index angle.

4.8.2.7 Code 510: Electronic Spindle Setup

Use these service codes to setup or troubleshoot the electronic spindle.

1. **CAL RPM** – Running this routine will automatically calibrate the spindle over several increments from its minimum to maximum rated speed. The process should take between 1-2 minutes to complete.
2. **ORIENT SPINDLE** – This sets the orientation of the spindle in relation to the ATC when the machine performs a tool change. Follow the instructions on screen to set or verify the orientation of the spindle.
 - a) **ATC IN** – Brings the ATC in towards the spindle. Make sure the Z axis is high enough to clear the ATC before using.
 - b) **ATC OUT** – Moves the ATC back out and away from the spindle.
 - c) **ORIENT ON / OFF** – Pressing this button will make the spindle turn to the orientation offset that is currently saved, and hold position. Pressing it again will release the spindle so that it can be turned manually if necessary.
3. **ENC CHECK** – Use to verify the spindle encoder is functioning properly. For every revolution of the spindle, you should see 4096 counts on the screen. The counts should also reset to 0 once the encoder reaches the index pulse. You can turn the spindle manually, or use SPIN SPEED to enter an rpm, and press FWD to power on the spindle.

4.8.3 Section C - Diagnostic Code Details

The following codes are used primarily when diagnosing a problem with the machine. To get to any of these codes go to Service Codes, press "C" and press the code you wish to view.

4.8.3.1 Code 54: Program Continuous Run

This Code runs a program continuously without stopping for GO commands. It is helpful in running a long period to identify an intermittent problem.

Prepare a program as you normally would.

Press **MODE, SET UP, "C", Code 54, INC SET**. The program run will start automatically.

Press **STOP** to stop, and **GO** to continue.

4.8.3.2 Code 81: Program Panel Test

This code is used to check if the buttons located on the program panel are functioning correctly. It allows you to test each key individually. When you press the keys, the corresponding box for that key will highlight on the screen. The pendant will also beep, indicating that the key is working correctly. If one of the keys does not work, the program panel assembly or run panel may need to be replaced. If none of the keys are working, you may want to check the connections from the back of the program panel or run panel to the overlay interface board.

4.8.3.3 Code 131: Manual DRO

A manual diagnostic routine used to check the motors' encoders. Manually turn the X or Y axis ballscrew to display the actual DRO counts and the raw encoder counts. The DRO will display counts unaffected from calibration compensation.

4.8.3.4 CODE 132: Electronic Handwheel Test

This service code can be used to troubleshoot any issues seen with the electronic handwheel. Simply turn the handwheel in either direction, and the display should increment 1 count per click, 100 counts per revolution. The counts are the same for the front panel handwheel on the run panel as well as the three EHWs.

4.8.3.5 Code 314: Toggle Test Lights 'On' in Status Line

This code toggles a group of test lights up on the top of the display when turned ON. The lights are used to help determine if there are any communication problems between the computer and the motion control hardware. They would ideally be used for issues where the control appears to be slow to respond, or not responding at all, especially when trying to run a program. An SWI Service Rep may ask you to turn these lights on and describe their status while troubleshooting.

4.8.3.6 Code 319: Error Log

This code when turned on captures the commands that were sent to the servo system. It includes items such as positioning commands, errors, stop and go commands, feed rates, etc. It may be helpful for identifying problems between programmed commands and executed commands. To turn the error log on / off, press the F6 softkey. Use the left and right arrow keys to scroll through the file one page at a time. Use the up and down arrow keys to scroll through the file one line at a time. The DATA BOTTOM key takes you to the bottom of the file and then changes to DATA TOP which will take you back to the top. The file will capture data until the file reaches a size of approximately 20 MB. At this time the file is saved to a backup file and the original file is cleared and data is once again captured. Once again as the file

reaches a size of 20 MB it copies over the previous backup file. From here the user can save the file to a USB flash drive by pressing the F8 softkey. Once this is done it prompts you to save the file. The file will be saved as a zip file to your USB device. The file will be called errorlog.zip. To clear the contents of the current log, press the CLEAR FILE button.

4.8.3.7 Code 326: Error Message Display

Useful for checking error messages if the error number is already known.

4.8.3.8 Code 327: Display Memory Check

This service code is used checking the amount of free memory available from system RAM. This can be useful for troubleshooting any issues where memory may be a factor, such as system slowing down, or intermittently not responding. Press the **DRIVE SPACE** button to check the amount of free space on the system drive as well as removable devices such as USB flash drives. A service technician may ask you to take note of these screens while troubleshooting certain computer related issues.

4.8.4 Section D - Operator Defaults/Options Codes Details

The following codes allow the user to set programming defaults or turn features on or off. To get to any of these codes go to Service Codes, press "D" and press the code you wish to view.

4.8.4.1 Code 79: Beeper On

This turns on the beeper to the control keys.

4.8.4.2 Code 521: Check Control /Indexer IO

This service code will launch an external application that can be used to check all the control's inputs and outputs. This service code should be used only by qualified service technicians.

4.9 Critical Service Codes that Must Be Performed

The following table summarizes the critical service codes that must be performed after working on certain aspects of the machine.

#	Service Code	When	Consequence
2	501 – setting the tool change height	<ol style="list-style-type: none"> 1. Motor removed or replaced 2. Ballscrew coupling slips 3. Limit switch replaced or a major mounting adjustment is made. 4. Limit switch cam replaced or a major adjusted is made. (This only applies to the limit switch cam used for homing) 5. ATC carousel replaced (Should be OK but this needs to be checked) 6. Spindle cartridge replaced (The height of the tool relative to Z home may be slightly different) 7. Ballscrew replaced 8. Angular contact bearings on motor end replaced 9. Head removed from machine and hence separated from linear guides 10. Computer module or compact flash has been replaced and the configuration file was not loaded into the new computer. 	<ul style="list-style-type: none"> • The user may crash the tool into the tool changer and damage key components. Repairs could be expensive and time consuming to replace • Some of these items refer to when working on the Z axis
4	505 – checking the motor index angle. Must be set to 180° +/- 45°	<ol style="list-style-type: none"> 1. Motor removed or replaced 2. Ballscrew coupling slips 3. Limit switch replaced or a major mounting adjustment is made. 4. Limit switch cam replaced or a major adjusted is made. (This only applies to the limit switch cam used for homing.) 5. Ballscrew replaced 6. Angular contact bearings on motor end replaced 	<ul style="list-style-type: none"> • This code applies to any work done to the X, Y and Z axis. • As a secondary item, you should rerun this same code and reset the soft limits.
5	510 – setting the spindle orientation angle	<ol style="list-style-type: none"> 1. Spindle motor belt has been removed, replaced or has slipped during operation 2. Spindle motor has been replaced 3. AC spindle drive has been replaced (Need to reset parameter 10-19, each machine has a unique value) 4. Computer module or compact flash has been replaced and the configuration file was not loaded into the new computer. 	<ul style="list-style-type: none"> • The user will most likely break a finger on the ATC. More severe damage could also occur which could be costly to the user.

5.0 Procedure for Replacements & Maintenance

5.1 Replacements

5.1.1 Servo Drive Replacement

The Servo Drive (figure 5.1.1) for each axis is mounted in the electrical cabinet using (4) M8-25 25B cap screws.

1. Press in the Emergency Stop.
2. Remove power from the machine.
3. Disconnect the two digital cables with DB connectors (CN1 and CN2).
4. Disconnect the incoming motor power 8 individual wires with lug termination from the X & Y drives (labelled L1-6, L2-6, L1-7, L2-7, L3-7, U, V, W). Do not pull on the wires.
5. Disconnect the incoming motor power 10 individual wires with lug termination from Z drive (labelled L1-6, L2-6, L1-7, L2-7, L3-7, U, V, W, P, C). Do not pull on the wires.
6. Remove the three green ground wires (labeled "GND") by removing the green screws on the bottom left corner of the unit.
7. Mount the new servo drive in the cabinet using (4) M5-0.8X10 25B cap screws.
8. Reconnect the green ground wires followed by the two digital cables and 8 or 10 power wires based upon the drive.

WARNING!

Do not remove the Servo Drives unless the power is disconnected from the machine. The servo drives are run by 220 VAC. There is possibility of death by electrocution!

Do not work with the brushless motors unless the power is disconnected from the machine. The motors are run by 220 VAC. There is possibility of death by electrocution!



Figure 5.1.1 - Servo Drive and Motor

5.1.2 Programming Panel, Run Panel and Computer Module Replacement

Note - The design of the TMC allows easy replacement of the programming and run panel assemblies. The sections below will provide instructions for Programming Panel, Run Panel, Hand Wheel, Key Lock, Emergency Knob, and Computer Module replacement if needed.

5.1.2.1 Programming Panel Replacement

1. Turn power off to the machine and control.
2. Remove all cover bolts on the rear of the Pendant except the top two which allow support of the panel while you remove the remaining bolts. The holes are slotted so you can lift the panel with the top two bolts in place.
3. Disconnect the following cables as shown in figure 5.1.2.1:
 - a. USB Ports (4) and Audio mounted on the medal pendant casing
 - b. DB25 Umbilical cable assembly
 - c. 4 ribbon cables from RUN PANEL to Programming panel overlay interface board
 - d. Both LAN cable assembly
 - e. E-stop cable wire assembly
 - f. RSG connector remove screws from the bottom of medal pendant casing as shown in image

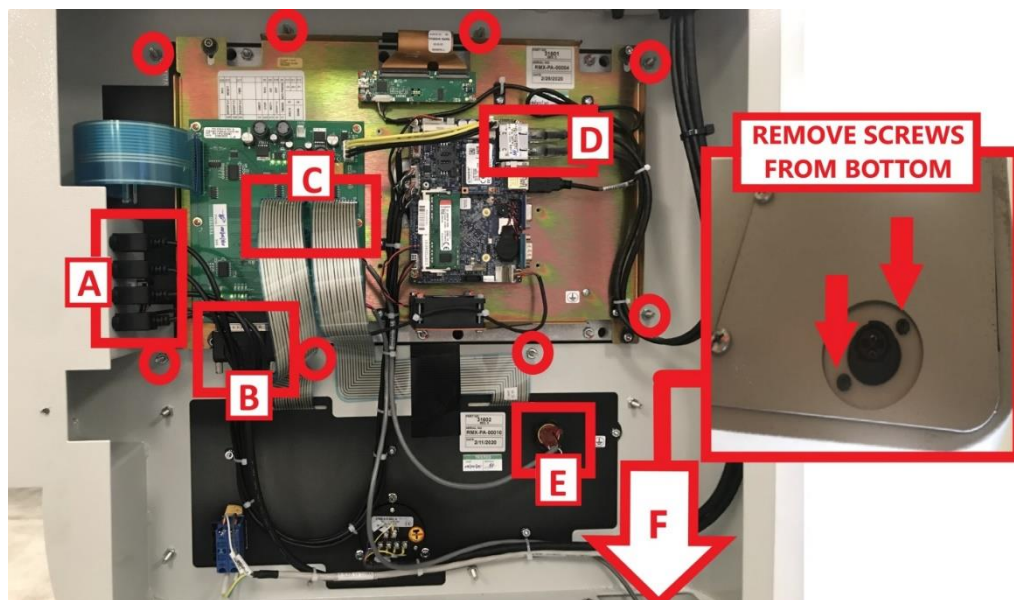

Figure 5.1.2.1 - Panel Cabling

4. Support programming panel from the front and remove the 8 bolts from the programming panel perimeter and remove the panel from the front of the pendant as shown in figure 5.1.2.1.
5. Replace programming panel, replace the bolts and tighten just past finger tight, connect the data wires listed in step 3 and shown in figure 5.1.2.1. Replace rear cover and tighten bolts.
6. Power up the TMC.
7. May need to update software, check Service Code 33. See section 4.8 Software Service Codes.

5.1.2.2 Pendant Run Panel Replacement

1. Turn power off to the machine and control.
2. Loosen all cover bolts on the rear of the Pendant.
3. Remove all cover bolts except the top two which allow support of the panel while you remove the remaining bolts.
4. Four ribbon cables on the run panel are not field removable from the run panel so, carefully remove them from the programming panel end as shown on figure 5.1.2.2.
5. Disconnect the tape, tie downs, cables to the E-Stop switch, EHW, and key switch as shown in figure 5.1.2.2.
6. Support the run panel from the front and remove the seven bolts circled as shown in figure 5.1.2.2.

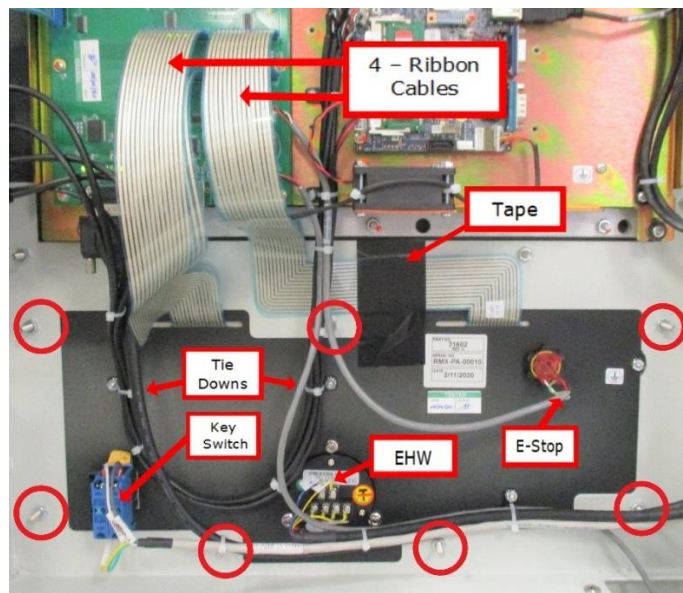

Figure 5.1.2.2

7. Replace run panel, replace the bolts and tighten just past finger tight, reconnect the data wires, ribbon cables, tie downs, tape, rear cover and tighten bolts.
8. Power up the TMC.

5.1.2.3 Pendant Hand Wheel, Key Lock Switch or Emergency Off Knob Replacement

1. Turn power off to the machine and control.
2. Remove the wires and hardware to the part being replaced as shown in figure 5.1.2.2.
3. Replace the part and reconnect hardware and wires.
4. Replace the rear cover and tighten bolts.
5. Power up the TMC.

5.1.2.4 Computer Module Replacement

1. Turn power off to the machine and control. Disconnect TMC from power source.
2. Start with the power cord in the upper right-hand corner and unplug all the cables connected to the Computer Module as shown in figure 5.1.2.4.
3. Remove the Computer Module from the Programming Panel by removing the 6 screws (circled in figure 5.1.2.4), 3 along the top and three along the bottom of the enclosure.

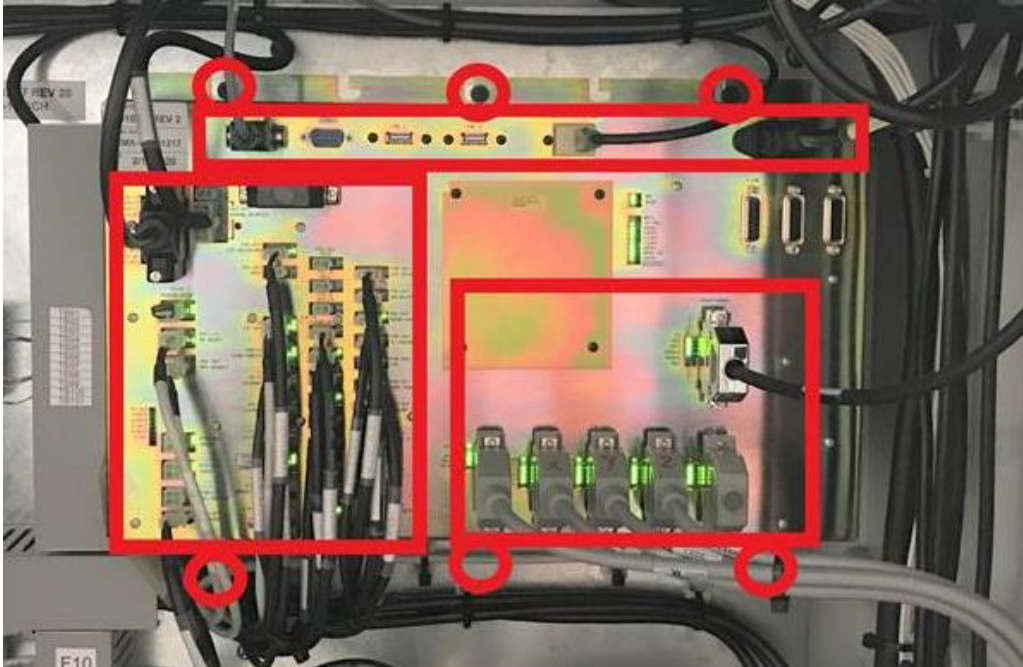

Figure 5.1.2.4 - Computer Module Replacement

4. Replace the Computer Module and reinstall.
5. Replace the cables connected to the Computer Module as shown in figure 5.1.2.4. Each cable is marked with its location on the enclosure, be sure to double check the correct wiring before attaching the power cord.
6. Attach the power cord to the computer module and power up the TMC.
7. May need to update software, check Service Code 33. See section 4.8 Software Service Codes.

5.1.2.5 TMC Computer Components

TMC Computer Components		
Item	P/N	Description
1	31601	TMC PROGRAMMING PANEL (In Pendant)
2	31602	TMC RUN PANEL (In Pendant)
3	29100-1	TMC COMPUTER MODULE (In Electric Box)

5.1.3 Updating the Pendant and CM Software

1. On the pendant, touch the "Status" soft key on the upper left portion of the touch screen. This will display the pendant and CM software version.
2. To verify the current software versions, go to <https://www.southwesternindustries.com/software>
 - Click on the "Current ProtoTRAK CNCs Software" tag. Find the RX section and refer to the software versions list.
3. To update to a more current version, first download the software from the website onto a USB Flash Drive.
4. Plug the USB Flash Drive into one of the pendant USB ports.
5. On the Pendant, select the soft key "Service Codes". Type in "316" and press the ABS Set key. Follow the instructions on the screen.

Note - Your configuration/calibration settings will not be changed by this procedure. If you wish to store your settings on a USB Flash drive, install a drive in one of the ports and use Service Code 142 to save the values. Service Code 141 can be used to restore the values on your Flash Drive back onto the pendant.

5.1.4 Adding Solid State Drive (SSD) Memory Option

TRAK provides an option for the TMC that allows customers access to a large amount of disk storage space for their custom programs specific to their business. Part number for this kit is: MEM-TMC or 31508. This provides an archive of production programs in the Pendant readily accessible for operations and reduce the need to transfer programs from other storage devices.

1. Power down the TMC. Pendant rear cover must be removed. Use caution, this is a heavy cover. There are slots for each bolt that allow the technician to loosen the upper bolts to support the weight of the cover while the remaining bolts are loosened and removed. The Pendant circuit board is Part # 31601.
2. Memory kit includes the needed hardware for this installation:

Part Number	Quantity	Description
31616	1	Bracket
31625	1	Programmed 2.5" SSD Memory Card
6-32X1/4 X1 1/4	4	Standoff- HEX Male/Female Aluminum
6-32x1/4	4	Screw PH Phil EXT SEMS STL BO
Small	4	Screws to attach Memory card to bracket

3. Use the four standoff studs and place them in the threaded holes that match the pattern for the memory bracket as shown in Photo 5.1.4a. These do not need to be very tight, just firm. Align the bracket on the four standoffs and use the supplied screws and tighten just past finger tight.

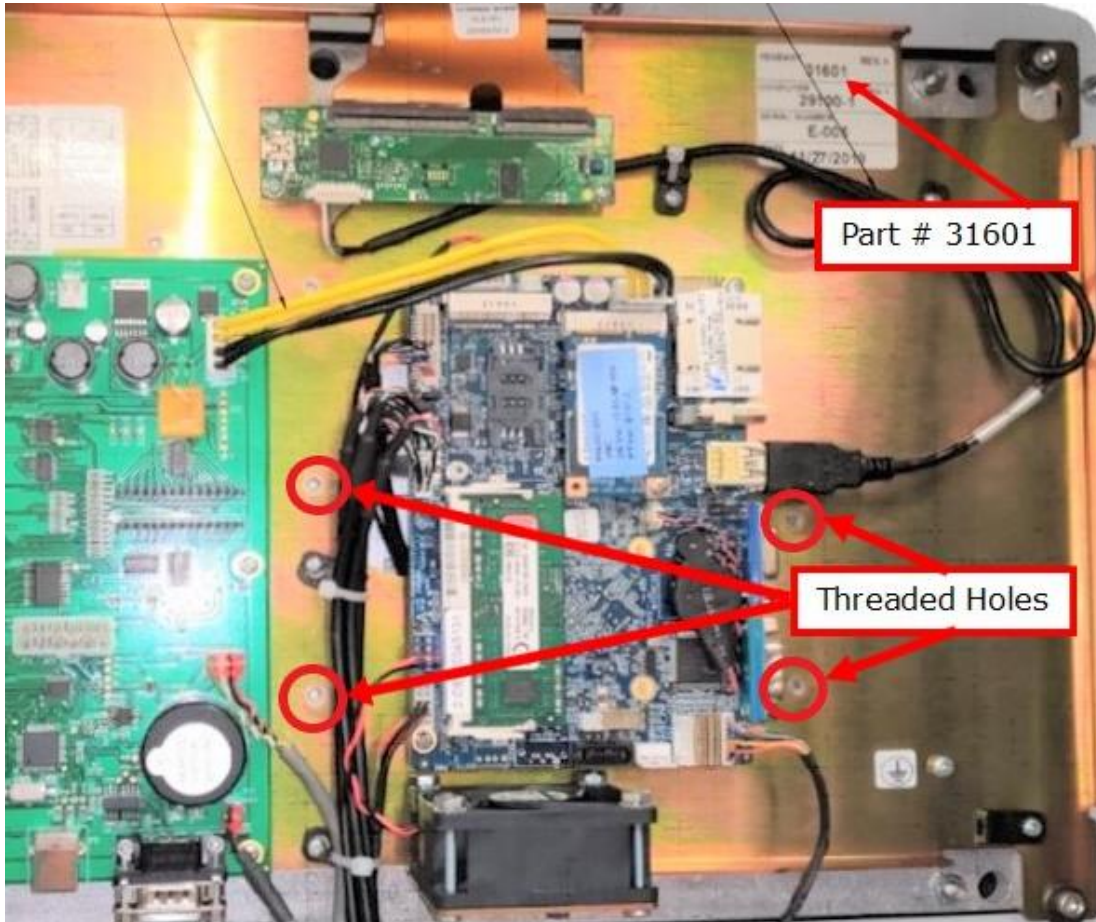

Figure 5.1.4a

4. The memory card needs to be installed on the bracket with the four small screws provided from the rear of the bracket into the memory card. The bracket is then installed on the four standoffs with screws provided. Figure 5.1.4b shows the bracket installed and where to locate the memory card.

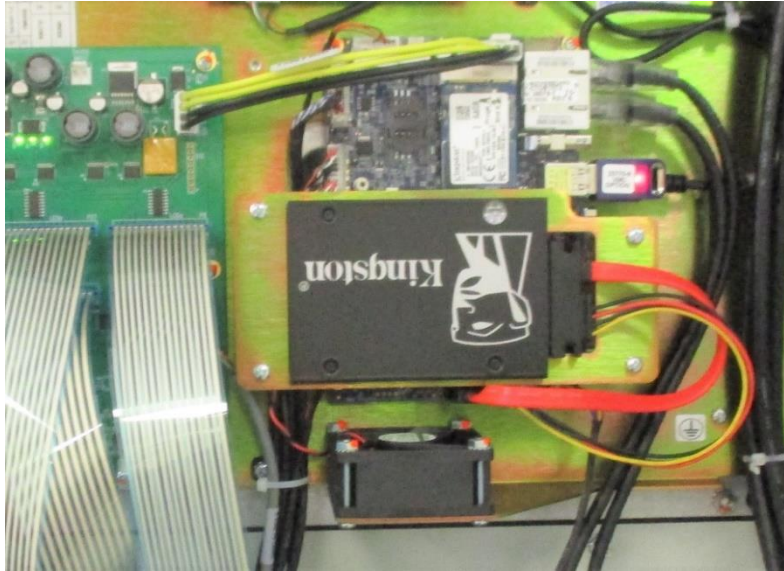

Figure 5.1.4b

5. Install Cable on SSD card which consists of either two separate cables (power and data) or one cable with two wires attached. Each cable has a notch on the connector that only permits the cable to be installed one way due to the matching notch on the memory card and the sizes of the wires as shown in Figure 5.1.4c.

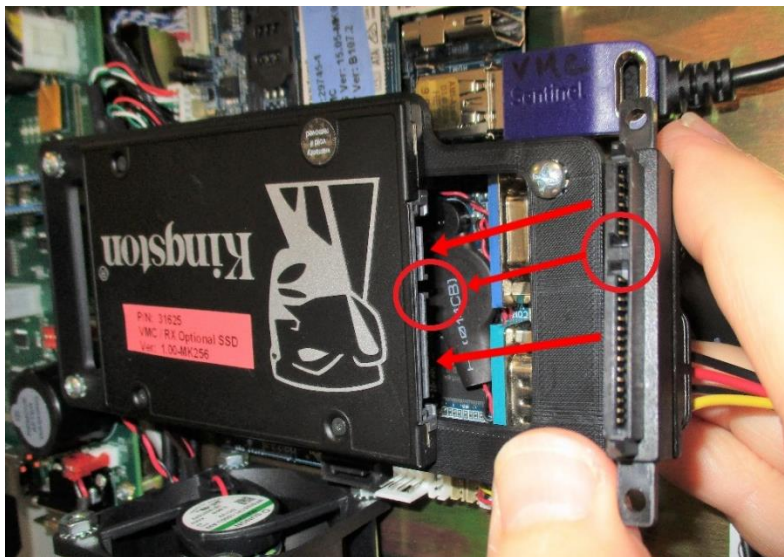

Figure 5.1.4c

6. The memory card cable branches into a data and power cables to be connected into the circuit board behind and below the memory card just installed. The data cable terminates with same type of notch as used in the large end preventing an error while attaching the connector. The smaller white power connector has a wide notch with a tab along the bottom which forces the install only one way as shown in Figure 5.1.4.d.

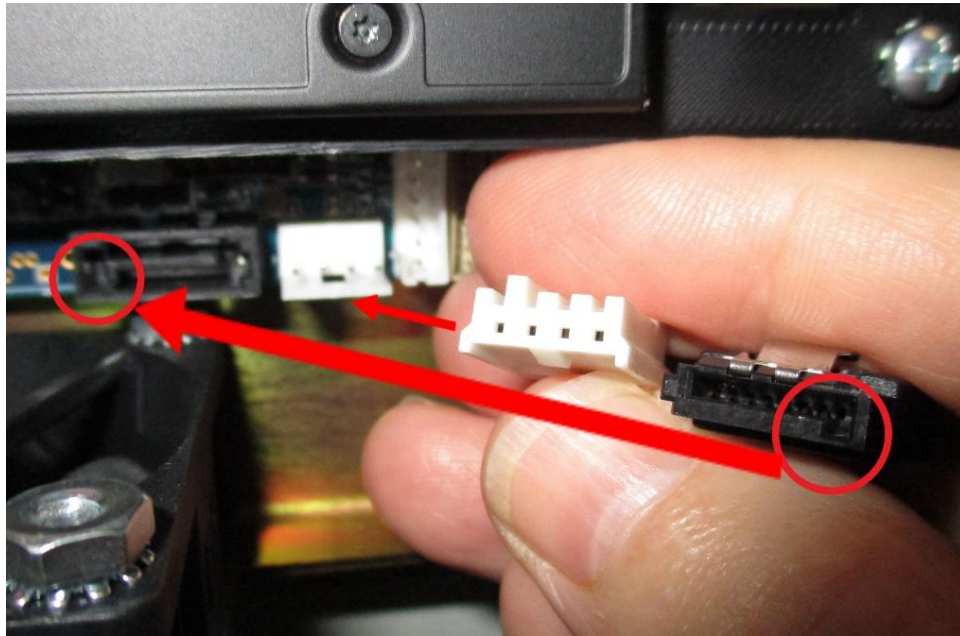

Figure 5.1.4d

7. Make sure the cable is safe the way it is routed from the SSD card to the circuit board connections. The cable should be loose and not bound on a metal corner, cover or another object. Reattach the cover and firm the bolts. They do not need to be very tight. Power up the TMC and test the installation by inserting a removable USB drive into either USB port inside an alcove along the right edge of the pendant. Copy from the removable USB (Usually Drive E) to the new SSD memory (Drive D) to make sure the new memory card is working by sliding the Programming screen at the lower right corner to open the keyboard pop up. Press the Windows key on the lower left-hand corner of the keyboard to bring up Windows Menu. Select Devices & Printers and the Device Display lists the USB. Copy a test file from the USB to drive D the new memory card.

5.1.5 Cable Routing on Machine

Whenever you replace a cable or reroute a cable it is very important to keep the power cables and logic cables separated from each other. The power cables consist of the (3) 208-volt motor cables and (2) 208-volt power cables for the Computer Module and a coolant pump or lube pump cable. The logic cables are used to carry encoder signals between the servos and computer module. Mixing of the power and logic cables may cause noise from the power cables to interrupt the signals in the logic cables. This can lead to intermittent axis faults or repeatability problems.

5.1.6 Electronic Handwheel Option

TMC has the option to have X, Y and Z handwheels included with your mill. The handwheels are mounted on the machine by the use of 4 SHCS.

Electronic Hand Wheels are a proprietary option on a wide range of TRAK Mills, which provide a high level of precise control over the movement of X, Y and Z axis while providing a high level of protection for the operator. Operator safety as well as precise control of the machine are provided with our hand wheel option.

Our ProtoTRAK software provides control of these handwheels at various speeds. There is a fast course mode to allow rapid movement on a mill when not close to a work area or other objects. We also provide precise fine control over the hand wheels when needed for slow accurate movement while zeroing out an axis as well as other tasks.

Figure 5.1.6a shows a detailed photo of a handwheel before installation on a TMC.



Figure 5.1.6a

Photo 5.1.6b shows the X, Y, & Z axis of a TMC on the job using the Electronic Hand Wheel option. In practice, the EHW are a big help and time saver for the production floor.

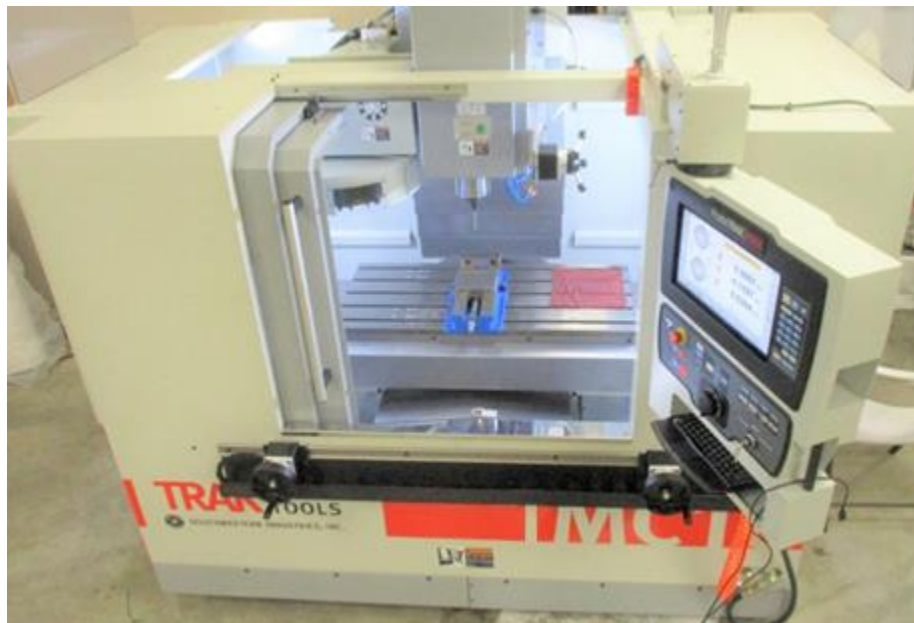

Figure 5.1.6b



Figure 5.1.6c

The X and Y axis EHWs are mounted on a track along the front of the mill. Not only do the EHWs give you precise control over the table movements, but you have the flexibility to use them wherever along the track works well for the current production task or the needs of the operator. They can be easily moved because of the type of track we use along the mill. The Z axis handwheel is installed on the spindle which will function like a quill on other TRAK Mills.

Two EHWs are attached to the rail and easily adjustable. Wiring for X & Y EHWs are protected in a special conduit which is also protected by the rail and can be adjusted many times. Figure 5.1.6c shows the external EHWs installed on a TMC and a detailed enlargement photo showing the conduit protecting the wires and how our rail design protects the wiring and conduit from damage on the shop floor. The handwheels are plugged into the Computer Module on the upper right section in the electrical cabinet. EHW cables are clearly marked for which axis they serve and the computer panel is also clearly marked with the connection for each EHW. See figure 5.1.6d for a photo of the upper right-hand corner of the computer panel located in the main electrical cabinet showing the location of the EHW wiring.

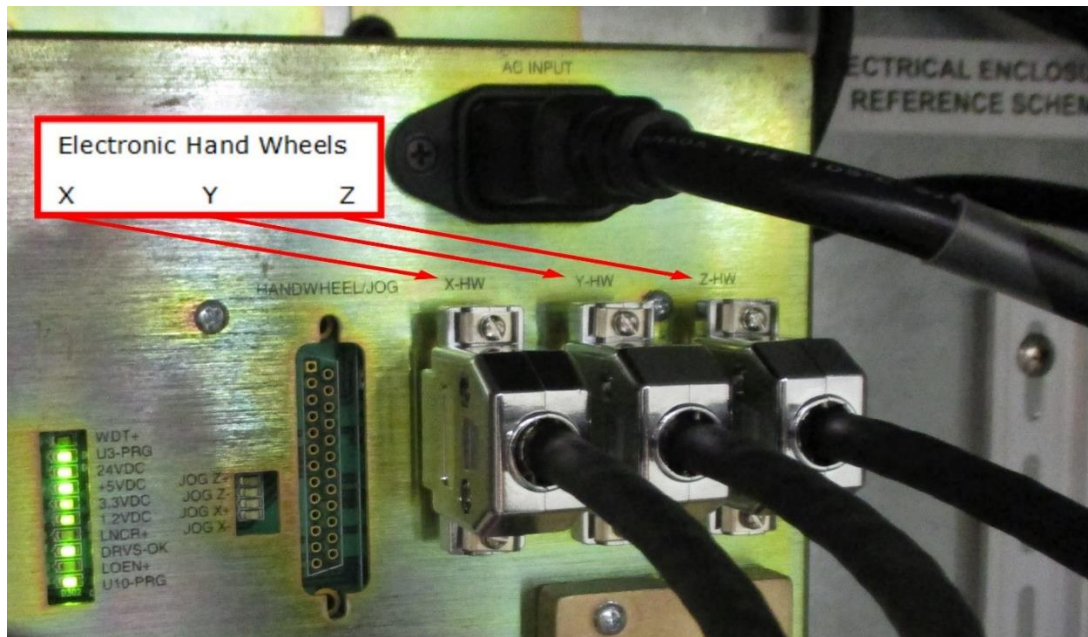

Figure 5.1.6d

Z axis EHW must be in a parked position (all the way back) when running in Production Ops. When Z axis is not parked, the PROTOTRAK control will limit how high Z axis can go. This prevents the Z axis EHW from crashing into the upper door rail.

5.1.7 Electronic Handwheel and Sensor Replacement

Instructions follow for the removal and replacement of optional EHW's.

5.1.7.1 Axis EHW Removal and replacement

The following instructions are to remove and replace the Z Axis EHW.

1. Move Y Axis forward to soft limit, move X Axis to negative soft limit.
2. Remove right side window or door.
3. Two cables from electrical cabinet should be disconnected from bracket on spindle side panel as shown in figure 5.1.7.2a.
4. Remove liquid tight fitting from panel.
5. Cut tie wraps holding cable to slide.
6. Disconnect Z EHW cable connector from bracket on side panel shown in figure 5.1.7.2a.
7. Remove 3 screws from EHW to slide and remove EHW. Install new EHW to slide.
8. Connect EHW cable connector into bracket mounted to panel
9. Connect liquid tight fitting to panel and new tie wraps.
10. Reinstall panel to Z Axis head while connecting cable from electrical cabinet back to bracket.
11. Replace window or door as needed.

5.1.7.2 Z Axis EHW Front or Rear Sensor Removal and Replacement

1. Move Y Axis forward to soft limit, move X Axis to negative soft limit.
2. Remove right side window or door.
3. Two cables from electrical cabinet should be disconnected from bracket on spindle side panel as shown in figure 5.1.7.2a and liquid tight fitting, which you will disconnect while doing step 4.

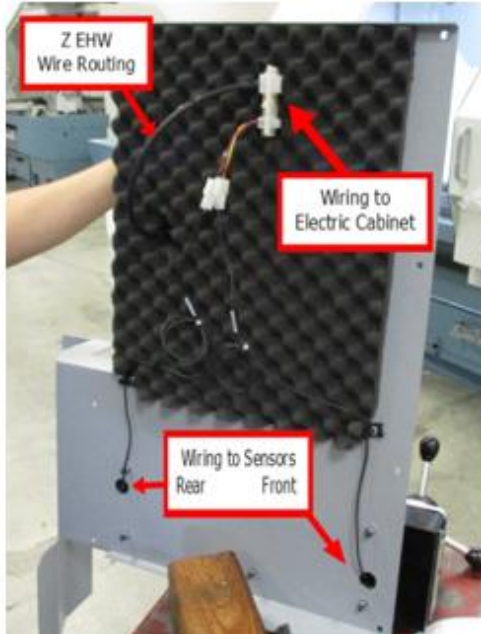

Figure 5.1.7.2a

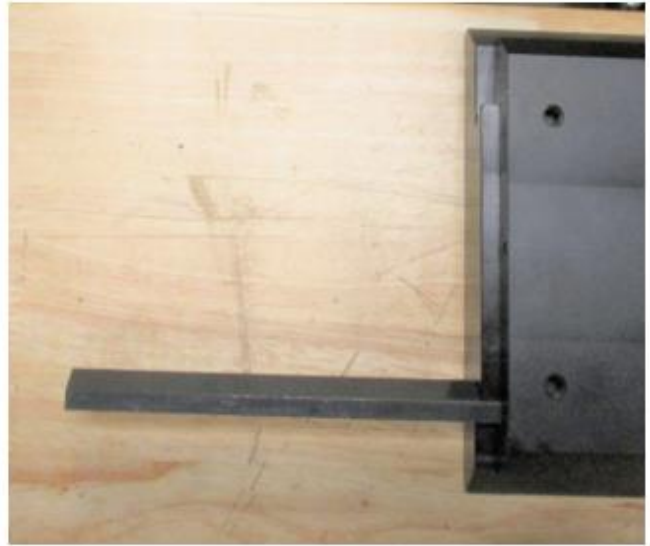

Figure 5.1.7.2b

4. Use M4 and M5 Allen wrench to remove spindle side panel, prop it for rear access.
5. Remove rear stop bracket and wiper.
6. Slide rail far forward enough to expose sensor needing replacement, gib may become loose as shown in figure 5.1.7.2b. Don't let it fall and keep it clean. You May need to cut tie wraps holding EHW cable for access.
7. Unplug front or rear sensor cable from bracket on side panel shown in figure 5.1.7.2a (viewed while removed from TMC for access).
8. Remove single Philips head screw holding sensor along rail without losing bracket behind sensor.
9. Reinstall rear stop bracket and wiper.
10. Install sensor cable to "Y" connector.
11. Reinstall panel to Z Axis head while connecting cables from electrical cabinet back to bracket.
12. Lightly grease gib and dovetail sliding surfaces.
13. Reinstall outer rail on inner rail and insert gib
14. Replace window or door as needed.

5.1.8 Auger Motor, Coolant and Coolant Wash Down Pump Replacements

5.1.8.1 Auger Motor Replacement

1. E-stop machine, power off Machine.
2. Trace electric wires from auger motor needing replacement. Auger motor connects to junction Q11 in the electrical cabinet as shown in figure 5.1.8.1a.

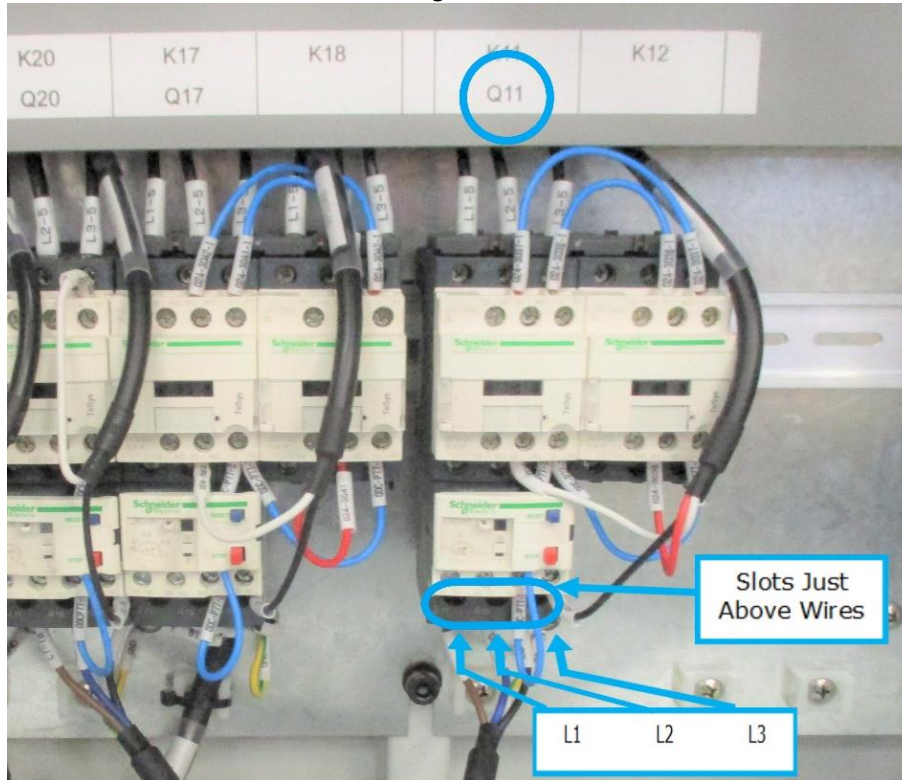

Figure 5.1.8.1a

3. Disconnect wires from Q11 and follow wires and remove them from the machine along with ground wire behind Q11 attached to plate.
4. Remove access plate above auger motor and loosen set screws attaching motor to auger bit. Be careful not to lose brass plugs behind coupling set screws.
5. Remove 4 SCHS head screws holding motor. Carefully slide out motor and remove set screws on coupler to release motor. Care needs to be taken not to lose brass plugs used at the end of the screws. Remove old motor.
6. Insert the motor into the housing using the 4 SCHS head screws and torque to specification.
7. Verify brass plugs are in auger coupling, tighten set screws.
8. Route power cable back thru machine following the same route during removal.
9. Connect L1, L2, L3 labeled wires as shown in figure 5.1.8.1a.
10. Power up machine and check operation making sure the motor turns the correct direction.

5.1.8.2 Coolant/Wash Down Pump Replacement

1. E-stop machine, power off Machine.
2. Trace electric wires from coolant or wash down pump needing replacement. Coolant pump connects to junction Q5 coolant and wash down pump connects to junction Q20 wash down in the electrical cabinet as shown in figure 5.1.8.2a.

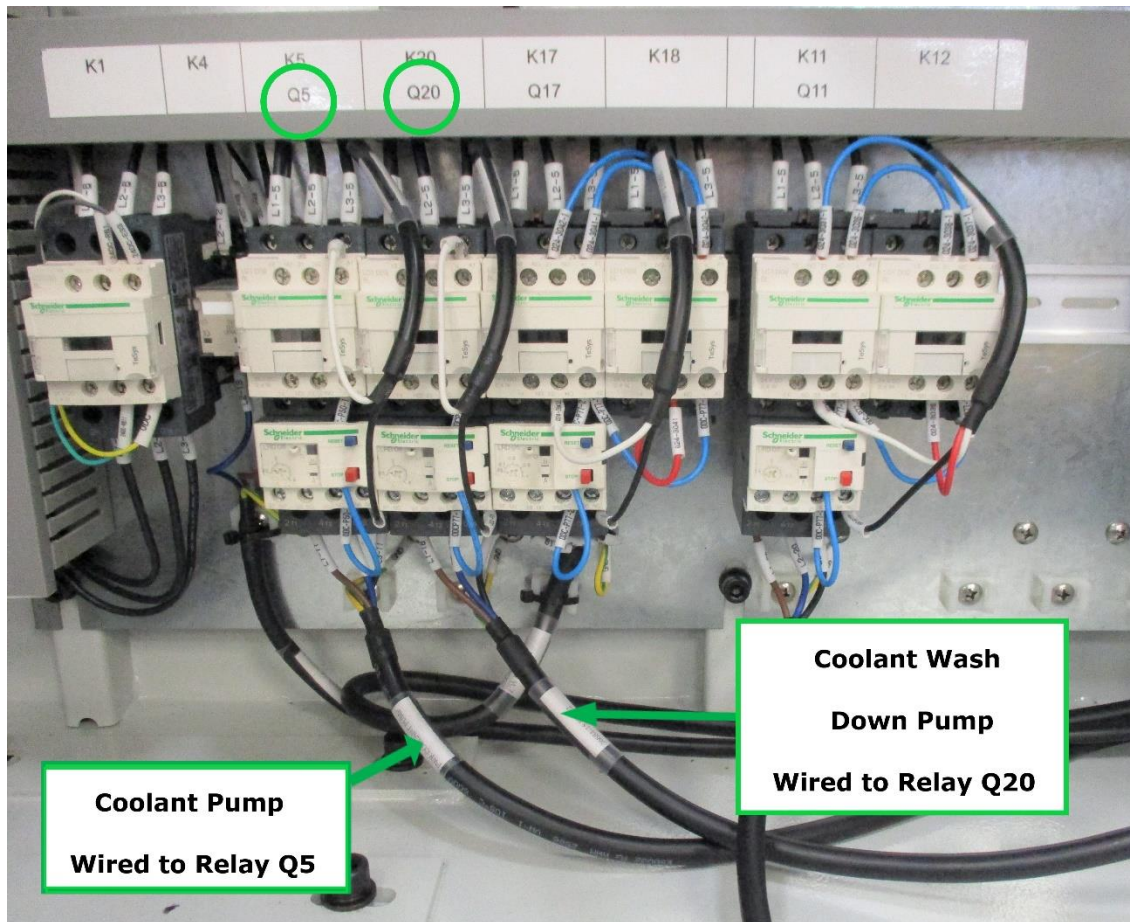

Figure 5.1.8.2a

3. Disconnect three power wires plus ground wire from junction and follow wires and remove them from the machine.
4. Disconnect coolant hoses from motor. Have container to catch any fluid remaining in lines.
5. Remove 4 SCHS head screws holding motor and remove motor from machine.
6. Replace motor, and replace the 4 SCHS head screws and tighten.
7. Route power cable back thru machine following the same route during removal.
8. Connect L1, L2, L3 labeled wires and ground wire as shown in figure 5.1.8.2b.
9. Power up machine, check operation and leaks, making sure the motor turns the correct direction.

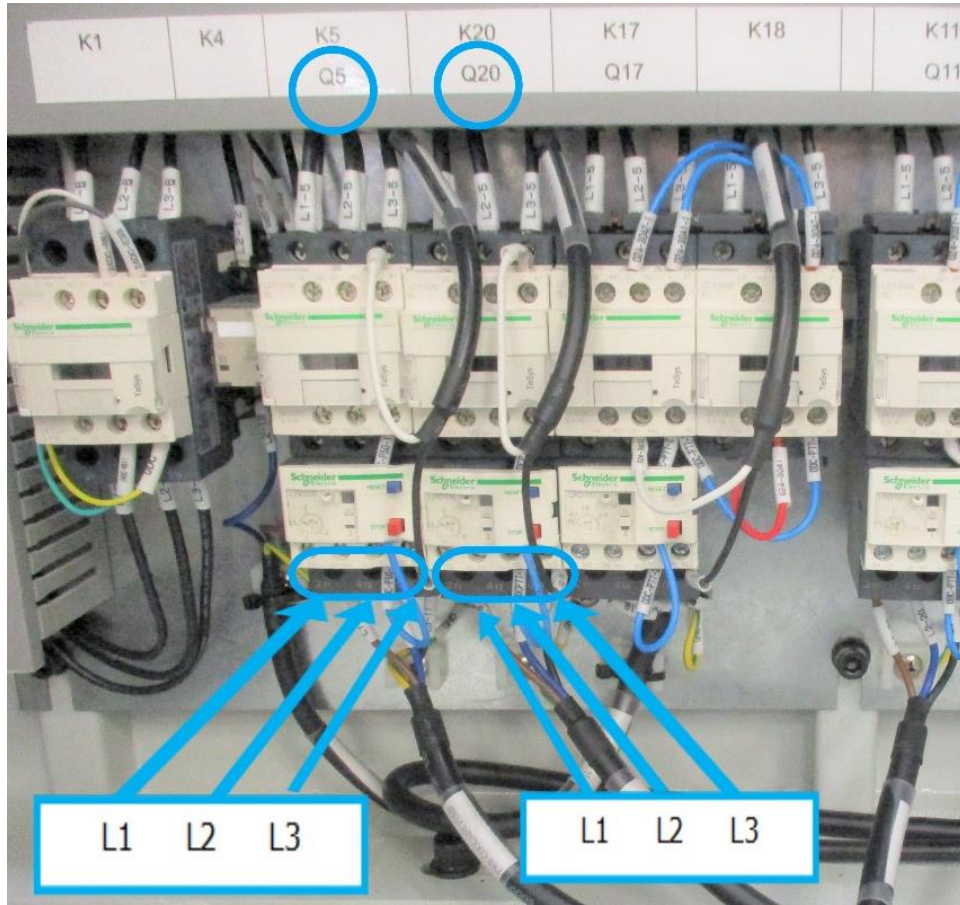

Figure 5.1.8.2b

5.1.9 Servomotor Replacement

The following service codes **must** be performed when a motor is replaced. Tool change heights will be off in the Z axis and should be adjusted. The machine may crash if these items are not set correctly.

- **Service Code 505** – Reset the motor index angle (machine may not home properly) and reset soft limits. Must be redone after any motor is removed.
- **Service Code 501** – Reset the tool change height. Performed after Z motor axis removal

5.1.9.1 X Axis Servomotor Removal and Replacement

1. Center X Axis, E-Stop machine and disconnect power to the machine.
2. Remove right way cover shown in figure 5.1.9.1a, coupling cover and rear motor panel cover for motor access as shown in figure 5.1.9.1b.

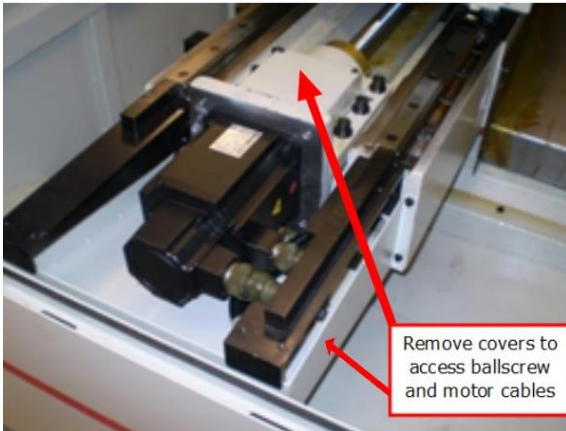

Figure 5.1.9.1a

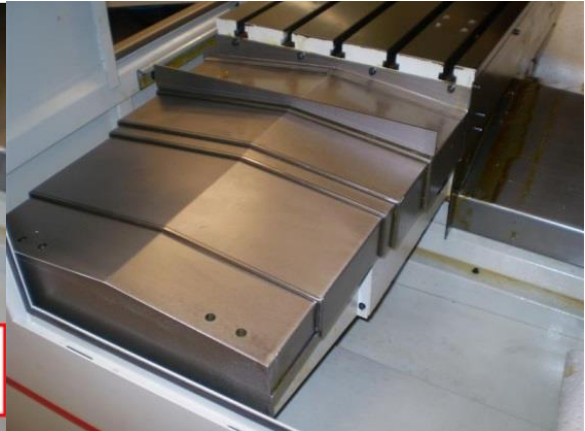

Figure 5.1.9.1b

CAUTION!

Edges of the way covers can be sharp, use leather gloves while handling.

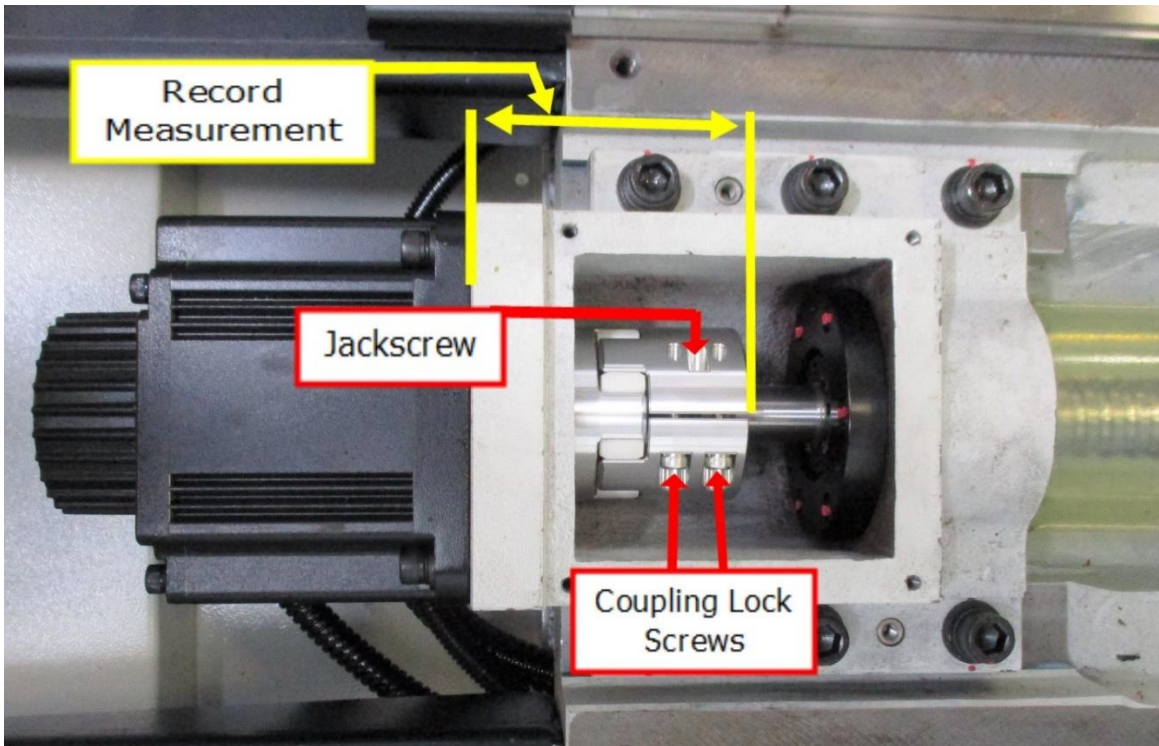

Figure 5.1.9.1c

CAUTION!

Do not touch the ball screw or linear ways with your bare hands.
Wear latex or other suitable gloves to protect precision surfaces from your hands.

3. Rotate the coupling until the slot is at twelve o'clock and you have equal access to the jack screw and the two clamping screws.
4. Use scale or caliper to measure distance from coupling edge on ballscrew side to the motor casting and take note of the measurement as shown on figure 5.1.9.1c. Loosen coupling lock

screws on ballscrew side of coupling. Tighten jackscrew to separate coupling from shaft as shown on figure 5.1.9.1c.

5. Disconnect two electric cables to motor. Remove four SHCS screws holding motor to mill.
6. Remove motor then remove coupler from motor shaft, examine the polyurethane spider element for excessive wear (there should be no visible backlash). If it is suitable for reuse, install it onto replacement motor shaft and set coupler distance from motor casting to coupler far edge using your recorded measurement.
7. Reinstall motor into mill.
8. Install and tighten four SHCS to 30 ft lbs.
9. Reconnect the power and encoder cables to the servo motor.
10. Enable servos, perform Service Code 505, slowly jog X axis into X Axis hard stop. Back out one ballscrew revolution and adjust home switch to trigger. Adjust index angle to 180 degrees +/- 40 degrees at 0.500" from hard stop.

WARNING!

After completing the replacement of the servomotor or ballscrew on the X or Y axis, service code 505 MUST be performed.

5.1.9.2 Y Axis Servomotor Removal and Replacement

1. Jog the Y-axis toward the operator as far as possible, E-Stop machine and disconnect mill power.
2. Y-axis access to the motor may require sliding the rear most way cover forward after removing way covers from inside the machine.
3. Rotate the coupler until the slot is at twelve o'clock and you have equal access to the jack screw and the two clamping screws.
4. Use scale or caliper to measure distance from coupler edge on ballscrew side to the motor to motor casting and take note of the measurement as shown on figure 5.1.9.1c. Loosen coupler lock screws on ballscrew side of coupling. Tighten jackscrew to separate coupling from shaft as shown on figure 5.1.9.1c. Y-axis may require touching as a reference or use of a mirror to complete this task.

CAUTION!

Do not touch the ball screw or linear ways with your bare hands. Wear latex or other suitable gloves to protect precision surfaces from your hands.

5. Disconnect two electric cables to motor. Remove four SHCS screws holding motor to mill.
6. Remove motor then remove coupler from motor shaft, examine the polyurethane spider element for excessive wear (there should be no visible backlash). If it is suitable for reuse, install it onto replacement motor shaft and set coupler distance from motor casting to coupler far edge using your recorded measurement.
7. Reinstall motor into mill.
8. Install and tighten four SHCS to 30 ft lbs.
9. Reconnect the power and encoder cables to the servo motor.

10. Enable servos, perform Service Code 505, slowly jog X axis into X Axis hard stop. Back out one ballscrew revolution and adjust home switch to trigger. Adjust index angle to 180 degrees +/- 40 degrees at 0.500" from hard stop.

WARNING!

After completing the replacement of the servo motor or ballscrew on the X or Y axis, service code 505 MUST be performed.

5.1.9.3 Z Axis Servomotor Removal and Replacement

1. Position the table to the approximate center of axis X and Y.
2. Jog the Z-axis upward and clear enough to allow the head support bracket to be placed beneath it.
3. Place the head support (supplied with the machine) on the protected table as shown in figure 5.1.9.3a and 5.1.9.3b. Place wood, foam, or some protection on top and bottom of the head support as shown in figure 5.1.9.3c.



Figure 5.1.9.3a

Figure 5.1.9.3b

4. Slowly and very gently jog head downward until contact is made with the table as shown in figure 5.1.9.3c. USE EXTREME CARE NOT TO PUT ANY UNNECESSARY FORCES ONTO THE TABLE!

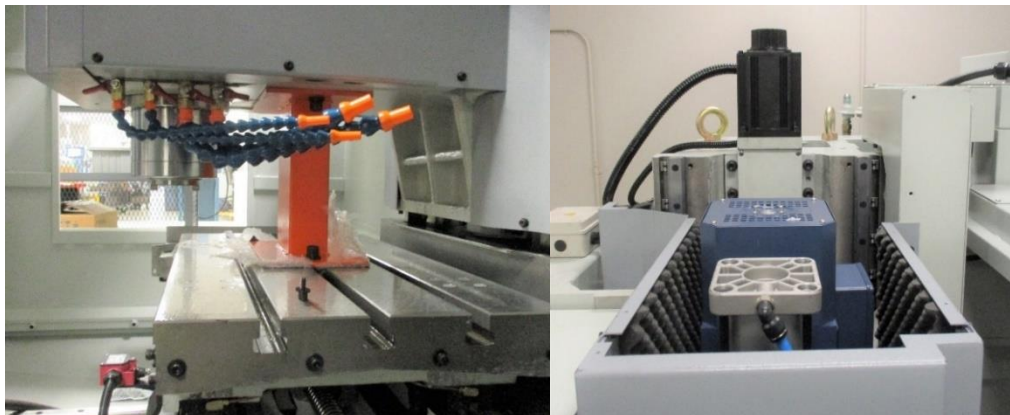

Figure 5.1.9.3c

Figure 5.1.9.3d

5. Press E-Stop
6. Turn off the power at the machines disconnect switch, and disconnect power.

7. Remove the coupler cover from the motor mounting bracket located behind the spindle drive motor as shown in figure 5.1.9.3d. The coupler slot should be facing outward toward the front of the machine.
8. Rotate the coupler until the slot is at twelve o'clock and you have equal access to the jack screw and the two clamping screws.
9. Use scale or caliper to measure distance from coupler edge on ballscrew side to the motor casting and take note of the measurement as shown on figure 5.1.9.3c. Loosen coupler lock screws on ballscrew side of coupler. Tighten jackscrew to separate coupler from shaft as shown on figure 5.1.9.3c.
10. Disconnect two electric cables to motor. Remove four SHCS screws holding motor to mill.

CAUTION!

Do not touch the ball screw or linear ways with your bare hands. Wear latex or other suitable gloves to protect precision surfaces from your hands.

11. Remove the coupler from the old motor, examine the polyurethane spider element for excessive wear (there should be no visible backlash). If it is suitable for reuse, set coupler distance on new motor using recorded measurement before reinstalling motor in mill.
12. Loosen the two SHCS that clamp the coupler, tighten the jack screw to open the coupler.
13. Set a gap of approximately 0.050" between each coupler half where they come together.
14. Install the motor onto the ball screw. Attach the four SHCS screws holding motor to mill to 30 ft lbs.
15. Loosen the jack screw (ball screw side), then tighten the two clamp screws opposite the jack screw.
16. Reconnect the power and encoder cables to the servo motor. Turn the power on the machine.
17. Enable servos, perform Service Code 505, slowly jog Z axis into Z Axis hard stop. Back out one ballscrew revolution and adjust home switch to trigger. Adjust index angle to 180 degrees +/- 40 degrees at 0.500" from hard stop.
18. Set the tool change height, perform service code 501.

WARNING!

After completing the replacement of the servomotor or ballscrew on the Z axis, service code 505 and 501 MUST be performed.

5.2 Maintenance

5.2.1 How to Clean the Touchscreen

When cleaning the touchscreen, make sure to turn off the machine. You can use any window cleaning solution to get any debris off of the screen. It is preferable to use a non-lint cloth when cleaning.

Note - *If you clean the screen with the power on, you may get false triggering or no touchscreen detection at all.*

5.2.2 Periodic Maintenance

The following table lists the periodic maintenance that must be done on a daily, weekly, month(s) and yearly basis. Contact TRAK to set up on site maintenance for your TMC and other TRAK Products. See section 2.15 for more information on lubrication related checks.

Maintenance Time Period	Items
Daily	<ol style="list-style-type: none">1. Drain the water from the air regulator assembly by either turning off the air to the machine or depressing the valve at the bottom of the water collector tank.2. Check to make sure there are no obvious oil leaks to the lubrication system.3. Check coolant level.
Weekly	<ol style="list-style-type: none">1. Check the level of the lubrication pump.2. Check the oil level in the oiler that supplies oil to the pneumatic components.
Month(s)	<ol style="list-style-type: none">1. Check the oil level of the Tool Change Air Cylinder Oil Cup, which is found under the sheet metal that surrounds the head. You can view this oil cup when the sheet metal is on by looking down from above.2. Every few months we recommend you remove the coolant tank and clean all debris and replace the coolant.3. Remove the air filters in the electrical cabinet every few months and clean.4. Check the level and tram of the machine every 6 months and adjust as necessary.5. Check the spindle motor belt tension every 6 months.
Yearly	<ol style="list-style-type: none">1. Check backlash on each axis and adjust as necessary.2. Remove all covers and clean chips and debris that may have built up.3. Inspect the ATC by removing the covers4. Inspect the tool change air cylinder5. Apply grease to the grease fittings on the ATC unit.

5.3 Laser Calibration

5.3.1 Accuracy

Your ProtoTRAK TMC is calibrated before it is shipped out to you using a highly accurate laser interferometer system. It is calibrated over 25mm increments along the length of each ballscrew, and saved onto a table within service code 123. We highly recommend creating your own backup onto a USB flash drive using service code 142, in the event that you need to replace your computer in the future. If needed, you can also contact us and we can email you the file from the time it was inspected.

5.3.2 Code 123: Calibration

From the main ProtoTRAK screen, go into SETUP, SERV CODES, CODE #, then type in 123 and press ABS SET. This will bring up the calibration page.

INFO	CODE 123 - Axis Calibration										MODES
STATUS	The ProtoTRAK VMC is to be calibrated with a laser system every 25mm of travel.										DRO
TOOL TABLE	To calibrate, select the axis to be calibrated. Press the RUN CAL PROG button to run the calibration program. The machine will move to the start position and prompt the user to press GO. The program will then move 25 mm with each GO press. The machine will move from the negative direction to the positive direction, starting at the most negative position in reference to machine home.										PROG
EPA											EDIT
MATH HELP	Note the position on the laser. A positive or negative calibration offset can be entered. The offset will be the machine position minus the laser position. A negative offset would indicate that the machine moved too far and a positive offset would indicate the machine is short of its target.										SET-UP
DEFAULTS	For example: If the calibration test program commanded the machine to move to -100mm, but the laser read -100.002mm, then enter -0.002mm for the offset.										RUN
KEY BOARD	"Clear All" resets all the calibration files and the offsets in the servo.										PROG IN/OUT
CALC	To check your calibration, press the RUN CAL CHECK button. This will run the program with the calibration offsets entered so you can check the accuracy of the machine.										
	X	Y	Z			CLEAR ALL					RETURN

X, Y, or Z – Will take you to the calibration offsets of the axis selected.

CLEAR ALL – This will erase all values within the calibration tables, for X, Y, and Z axis. This should only be used in the event that the system is being recalibrated by a qualified technician.

5.3.3 Calibration Table

Once an axis is selected, you will see the table where all the calibration offsets are stored.

INFO		X AXIS CALIBRATION									MODES	
STATUS	Pos	Distance	Offset	Pos	Distance	Offset	Pos	Distance	Offset	X	Y	Z
		1	0 mm	0.0000	15	-350 mm	0.0000	29	-700 mm	0.0000	-381.000	-254.000
TOOL TABLE	2	-25 mm	0.0000	16	-375 mm	0.0000	30	-725 mm	0.0000			
	3	-50 mm	0.0000	17	-400 mm	0.0000	31	-750 mm	0.0000			
EPA	4	-75 mm	0.0000	18	-425 mm	0.0000						
	5	-100 mm	0.0000	19	-450 mm	0.0000						
MATH HELP	6	-125 mm	0.0000	20	-475 mm	0.0000						
	7	-150 mm	0.0000	21	-500 mm	0.0000						
DEFAULTS	8	-175 mm	0.0000	22	-525 mm	0.0000						
	9	-200 mm	0.0000	23	-550 mm	0.0000						
KEY BOARD	10	-225 mm	0.0000	24	-575 mm	0.0000						
	11	-250 mm	0.0000	25	-600 mm	0.0000						
CALC	12	-275 mm	0.0000	26	-625 mm	0.0000						
	13	-300 mm	0.0000	27	-650 mm	0.0000						
	14	-325 mm	0.0000	28	-675 mm	0.0000						

Offset : 0.0000

RUN CAL PROG RUN CAL CHECK SAVE OFFSETS CLEAR RETURN

Press the **RUN CAL PROG** button, followed by the GO button to have the machine move to the home position of the axis you are calibrating. The other two axis will stay wherever they are. The first offset should always have a 0 value for its offset, since it's the starting point. Once the machine is at home, press the **GO** button to have the machine move to the next position.

Assuming that you have a laser system or some means of measuring the amount of table movement, you can now compare the actual distanced traveled versus what is displayed on the mini-DRO. Enter the difference between the two into the offset field. Enter a positive value in order to increase the travel, or a negative value in order to decrease the travel. So, for example, if after moving to the first position the mini-DRO read -25.000mm, but your laser system measured -25.002mm of actual movement, you would enter -0.002 as the offset value.

Note - This calibration table will always display metric values.

Press the **GO** button again to move to the next position. Keep entering the offset values for each position as described above. Once you have finished calibrating the axis, press the **SAVE OFFSETS** button to save the table to the machine. From then on it will begin using the calibration offsets. If you press RETURN and exit the screen before pressing **SAVE OFFSETS**, the values will not be saved.

After saving your offsets, you will want to press **RUN CAL CHECK** to run through the same sequence again, but this time the calibration offsets will be applied, and you can confirm the accuracy of the offsets that you've entered into the table with your laser system.

CLEAR – This button will wipe out all the values from the current calibration table. Only recommended if you know you need to recalibrate the machine.

6.0 4th Axis Option

TRAK manufactures a 4th axis option that can be retro-fitted onto a TRAK TMC at any time after its initial purchase. See figure below.

The 4th axis model's key features include:

- The unit doesn't require air.
- The unit is compact.
- The unit is sealed and lubricated for 20,000 hours of operation therefore no maintenance is required.



Figure 6.0 - 4th Axis Option

6.1 4th Axis Specifications

Spindle Diameter	8.07" (205mm)
Chuck Diameter	7.874" (200mm)
Overall Height of 4th Axis	13.82" (351mm)
Centerline Height of Spindle	6.30" (160 mm)
Minimum Resolution of System	0.001°
Maximum RPM	22
Repeatability	+/- 2 arc seconds
Indexing Accuracy	25 arc seconds
4th Axis Weight	190 lbs (86 Kg)
4th Axis Keyway Size	18 mm
Max distance between 4th axis chuck face & tailstock with center*	TMC5 – 6.26" (160mm) TMC7 – 14.14" (360mm) TMC10 – 22.79" (580mm)

* Chuck and adapter plate can be removed to add up to 4.65" (113mm) of additional distance. Chuck and adapter plate feed-through hole is 2.28" (58mm).

6.2 Mounting the 4th Axis

The images below demonstrate how the 4th axis unit and the optional tailstock mount to the TMC table. The 4th axis unit has an eyebolt attached to the top of the unit for lifting purposes. As shown in the image below, the 4th axis and tailstock have a key to drop in and slide to any position, on any T slot.

The 4th axis unit requires (2) cables to be connected and disconnected each time you add or remove the unit from the machine. See figure 6.2e. The cables are the electrical hookup to the servomotor, encoder, and home switch. Make sure the cables are securely fastened and locked in place.



Figure 6.2a – 4th Axis and Tailstock Option Mounted on TMC Table

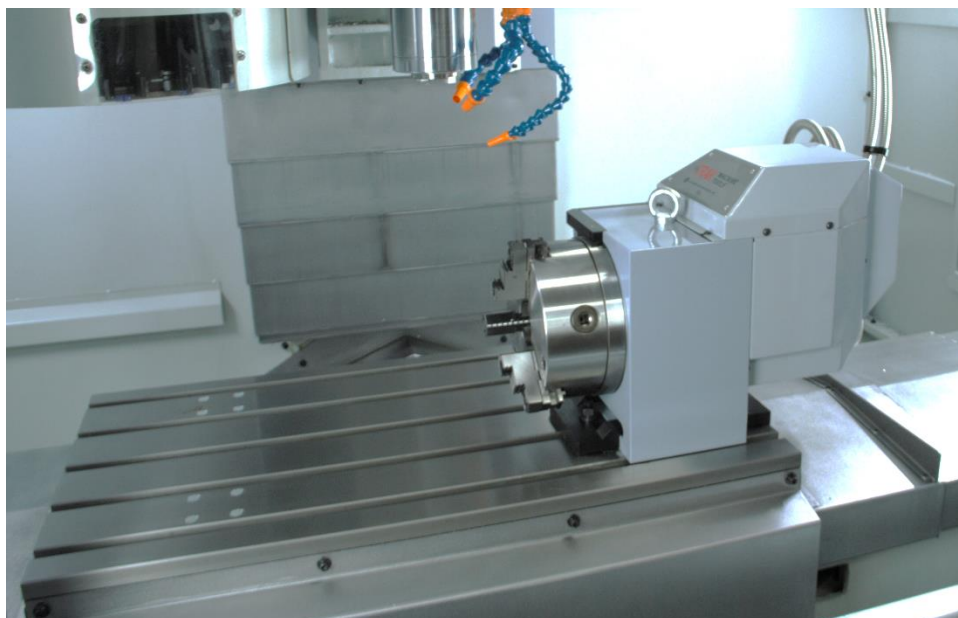

Figure 6.2b – 4th Axis Mounted on TMC Table without the Tailstock Option



Figure 6.2c – Clamping Block



Figure 6.2d – Tailstock Option

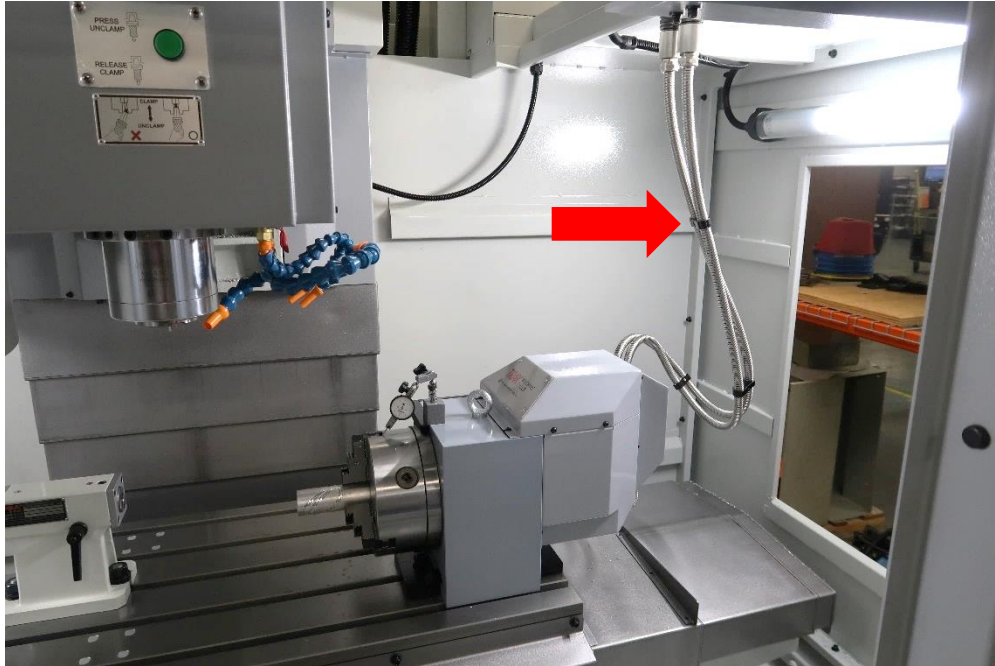

Figure 6.2e – 4th Axis displaying the (2) cables that are to be connected and disconnected each time the unit is added or removed from the machine.

6.3 Installation Checklist of the 4th Axis

Use this checklist to assure a complete install and setup of the 4th axis on the TMC.

Note - Steps included assume the installation was not completed at the factory.

Reference drawing 31538 at the rear of the manual for an illustration of the location of all items, how the parts are assembled, and the part numbers used.

4 th Axis Installation Checklist	
<input type="checkbox"/>	1. Turn off power to the machine when doing the electrical wiring in the electrical cabinet.
<input type="checkbox"/>	2. Open wiring access panels and remove knockout.
<input type="checkbox"/>	3. Install the 4th Axis Delta Servo drive.
<input type="checkbox"/>	4. Refer to drawing 31538 for Cable Routing Diagram. Use charts to connect wires.
<input type="checkbox"/>	5. Replace covers as needed when all the wires have been added.
<input type="checkbox"/>	6. Replace 4th Axis Jumper with the Delta Drive cable. Note - <i>When removing the 4th axis, install the jumper provided in the electrical cabinet on the computer module per the image below.</i>
<input type="checkbox"/>	7. Mount and align 4 th axis to the table.
<input type="checkbox"/>	8. Hook up the cables that come with the 4th axis to the top of the TMC.
<input type="checkbox"/>	9. Turn power on to configure the 4 th Axis.
<input type="checkbox"/>	10. Use service code 318 to turn on the 4th axis option software.
<input type="checkbox"/>	11. Confirm if the 4th Axis is enabled in Status menu.
<input type="checkbox"/>	12. Reboot machine. A reboot is not needed on software version 3.0.0 and newer.
<input type="checkbox"/>	13. Home the machine and verify that the 4 th Axis homes correctly.
<input type="checkbox"/>	14. Conduct the Burn-in Test Program.
<input type="checkbox"/>	15. Perform service code 502 to set the base tool.
<input type="checkbox"/>	16. Perform service code 506 to set the Y and Z offsets.
<input type="checkbox"/>	17. Perform or check that the backlash is set correctly using service code 128.

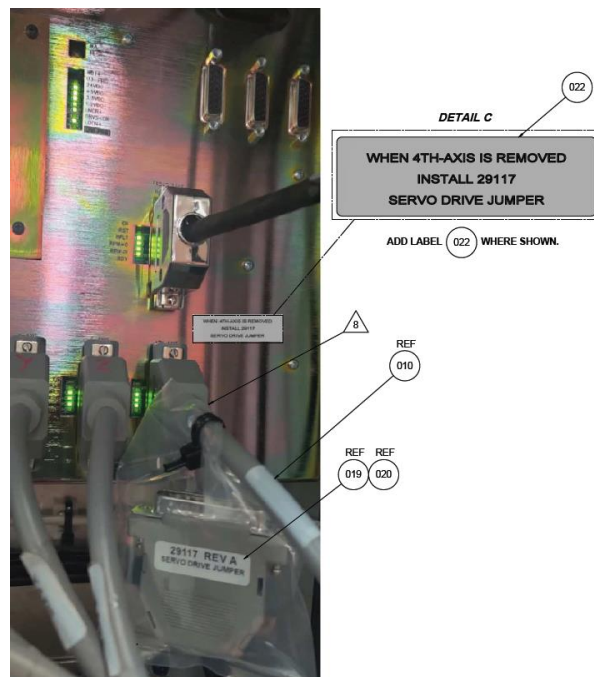

Figure 6.3 Jump and Computer Module

6.4 Service Codes: 4th Axis

The following service codes are specific to the 4th axis option.

6.4.1 Code 318: Turn on 4th Axis Option

Used to turn on the 4th axis option software.

6.4.2 Code 128: Input Backlash Constant

The following service code enters a backlash compensation value for each axis on the TMC. The A axis backlash is to be entered in a decimal angle.

Procedure to check backlash:

1. Mount an indicator on the 4th axis unit as shown in figure 6.4.2.
2. Go to DRO mode and load your indicator a few thousandths or 50 microns from one direction and set zero on your indicator and on your DRO. It is best to use the .0001" or 0.002 mm button when using the EHW for this.
3. Rotate the 4th axis in the same direction until you see a few thousandths or 50 microns of movement on the indicator.
4. Reverse the axis and go back to zero on the indicator. The amount of error you see on your DRO screen is your backlash.
5. Enter this into service code 128.
6. Now redo this procedure and make sure the DRO and indicator both come back to zero. Adjust as necessary.

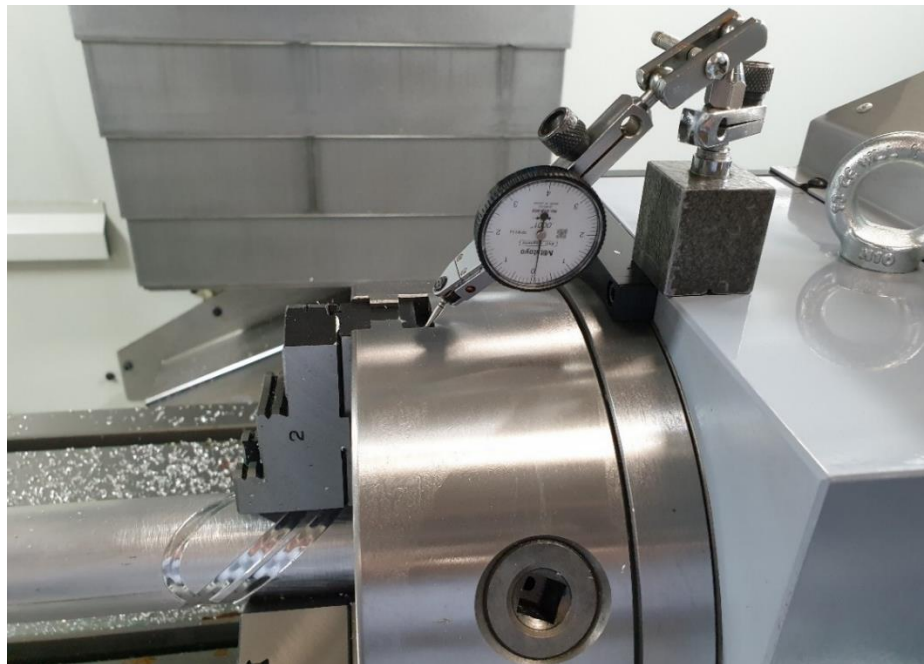

Figure 6.4.2 – Dial Indicator Mounted on the 4th Axis

6.4.3 Code 502: Set Base Tool Offset

Defines the distance from Z home position to the top of the table, using your base tool as reference.

6.4.4 Code 505: A Axis Motor Index

Added prompt for the A axis motor index. The Index Angle Test enables users to find the location of the 4th axis motor index relative to the home sensor. The value for A Index Angle must be more than 20° in either direction, from 0°. If this angle is off, it can be fixed by unbolting the adapter plate, rotating it 180°, and installing it again.

6.4.5 Code 506: Set 4th Axis Offsets

Set sets the Y and Z offsets for the 4th axis unit. The following describes what each offset is.

- **Y Offset** - The distance along the Y axis from Y home to the centerline of the 4th axis.
- **Z Offset** - The distance along the Z axis from the top of the table to the centerline of the 4th axis.

To set the Z offset location, there are a couple of ways we recommend measuring this offset.

Gage Pin Method

1. Mount a ground gage pin in the chuck of the 4th axis.
2. Make sure the pin is running true before measuring the height. Adjust the pin in the jaws as necessary to minimize runout. You may also want to make sure the chuck is running true before clamping down on the pin.
3. Take a dial indicator and set the indicator and DRO of the control to zero when touching the top of the table.
4. Now take the indicator and move the Z axis up and zero the indicator out on top of the pin. Find the highest point of the pin.
5. Take this DRO Z value and subtract ½ of the diameter of your ground pin. This is your Z offset.

Cutting a Part Method

1. Mount a round part in the 4th axis.
2. Cut a flat at 0° on the part.
3. Rotate the part 180° and cut another flat on the part. Make sure to cut the flat at the same Z depth for both cuts.
4. Take a micrometer and measure the distance between the flats and note this value.
5. Take a dial indicator and set the indicator and DRO of the control to zero when touching the top of the table.
6. Now take the indicator and move the Z axis up and zero the indicator out on top of the flat on your part.
7. Take this DRO Z value and subtract ½ of the number you came up with in step 4. This is your Z offset.

This service code is automatically backed up when you save your configuration file in service code 142.

6.5 Troubleshooting by Symptom

The following table lists a number of symptoms you may come across with the 4th axis unit.

Symptoms	Diagnostics or Possible Causes
4 th axis will not home or homes incorrectly	<ol style="list-style-type: none"> 1. Make sure the 4th axis option is turned on. Go to Setup Mode. 2. Verify the 4th axis can jog in DRO mode and move with the handwheel. 3. Check the sensor light status on the top of the 4th axis assembly. It should be ON with amber LED light for positions away from HOME and OFF when in HOME. The sensor light should change state with the rotation of the chuck across HOME position. 4. Check if the sensor light status on the top of the 4th axis assembly matches the green LED indicator on the computer module input P72-IN 4TH HOME. Check if the state of the LED changes with the change of state of the sensor LED light on 4th axis assembly.
4 th axis will not move when attempting to jog	<ol style="list-style-type: none"> 1. Make sure the 4th axis option is turned on. Go to Machine Setup Mode. 2. If a fault appears, double check all motor connections in the electrical cabinet. Check LED status on servo amp.
4 th axis is not coming back to zero	<ol style="list-style-type: none"> 1. Make sure the 4th axis homed properly. Go to service code 506 to home the 4th axis individually. 2. Make sure the backlash compensation is set correctly using service code 128. 3. Motor encoder may not be reading correctly
Cutter is chattering when cutting	<ol style="list-style-type: none"> 1. Make sure you setup is tight. Clamps on table, chuck and adapter plate, etc. 2. Make sure the unit does not have excessive backlash.
Parts are not accurate	<ol style="list-style-type: none"> 1. Possible programming error. Check your program. 2. Make sure the 4th axis homed properly. Go to service code 506 to home the 4th axis individually. 3. Make sure you have set your part zeros correctly. 4. Double check if service code 506 is set correctly. If these offsets are wrong, your part will come out wrong. 5. Check to make sure your backlash compensation is set correctly.

6.6 Servomotor Replacement Procedures

See drawings 31530 and 31538 at the rear of the manual.

Tools Required	
<input type="checkbox"/>	5mm allen socket with a ratchet handle with an 8" extension or 5mm T-handle allen wrench with an 8" reach
<input type="checkbox"/>	6mm allen socket with a ratchet handle with an 8" extension or 6mm T-handle allen wrench with an 8" reach
<input type="checkbox"/>	5/32" allen socket with a ratchet handle or 5/32" T-handle allen wrench
<input type="checkbox"/>	1/8" allen socket with a ratchet handle or 1/8" T-handle allen wrench
<input type="checkbox"/>	1/8" ball end allen wrench
<input type="checkbox"/>	Torque wrench

1. Press the e stop button.
2. Disconnect the cables from the machine.
3. The chuck and adapter plate do not need to be removed when replacing the motor, but it may be easier if you remove them.
4. Remove the motor shaft key retaining screw (item #35), retaining washer (item #33), washer (#32), and an O-ring seal (item #18), refer to assembly drawing 31530. Use a socket wrench with an 8" extension and 5mm allen socket, or a 5mm T-handle wrench.
5. Loosen side cable clamp (item #30), remove rear (item #12) and upper (item #11) sheet metal covers, remove cable clamps on lower sheet cover (item #9), and remove lower sheet metal (item #10). Refer to assembly drawing 31530.
6. Disconnect the motor cables from the motor.
7. Remove (4) motor mounting screws (items #43 & #44), use the socket wrench with 8" extension and 6mm allen wrench. Refer to assembly drawing 31530.
8. Remove the old motor and install a new one. (**Caution** - *The motor shaft key might have a snug fit and will require slight help using a 10" long brass or aluminum drift pin/rod and a hammer to drive out.*) Torque the motor mounting screws to 25 ft-lbs.
9. Connect the motor cables to the motor.
10. Install lower sheet metal.
11. Install cable clamps on rear cover.
12. Install the rear and upper sheet metal covers.
13. Tighten side cable clamp.
14. Install the motor shaft key retaining screw, washers, and O-ring seal.
15. Connect the cables to the machine.
16. Test the 4th axis to verify it operates properly.

6.6.1 Servomotor Replacement Service Codes

Perform the following service codes after a motor is replaced:

- **Service Code 505** - Check that the value for A Index Angle must be more than 20° in either direction, from 0°. If <20°, chuck will need to be removed, adapter plate will need to be removed, rotated 180° about spindle center, and remounted. Concentricity of adapter plate and chuck will need to be checked during reassembly.
- **Service Code 506** - Reset 4th axis, Y and Z offsets. See section 6.4.5 for additional information.

6.6.2 Chuck and Adapter Plate Removal and Replacement

The chuck that comes with the 4th axis unit fastens to an adapter plate, which in turn fastens to the spindle face of the unit. The chuck is held on to the adapter plate with (3) screws and the adapter plate is held on to the spindle face with (6) bolts. See figure 6.6.2



Figure 6.6.2 – Chuck and Adapter Plate

1. Remove the (3) screws that hold the chuck to the adapter plate.
2. Remove the (6) screws that hold the adapter plate to the spindle face.
3. Re-install the adapter plate and snug up the (6) screws that hold it to the spindle face.
4. Use an indicator to check the runout between the adapter and 4th axis unit. Tap the adapter plate until the runout is less than .0008". Try to get it as close as you can to zero.
5. Tighten the screws holding the adapter plate.
6. Install the chuck with (3) screws.
7. Use an indicator to check the runout between the chuck and 4th axis unit. Tap the chuck until the runout is less than .0008". Try to get it as close as you can to zero.
8. Tighten the (3) screws holding the chuck.

7.0 Coolant Through Spindle (CTS) Option

TRAK offers a Coolant Through Spindle Option. This provides the operator abundant coolant (or cutting fluid) right at the cutting surface to allow for high production speeds, aggressive feeds, all while keeping the coolant focused right where it is needed. Our CTS option can be used with collet-mounted tooling or with drilled tooling, once a CTS compatible retention knob is installed in the tool holder. Coolant is supplied from the coolant tank behind the TMC. A large, high-volume pump is part of the CTS option which provides ample coolant volume at the work area directly through the spindle. Figure 7.0 shows A TMC5 with the CTS option installed showing the shared coolant tray configuration with the other coolant pumps. Note: Augers are an option on TMC5s and this unit was not so equipped.

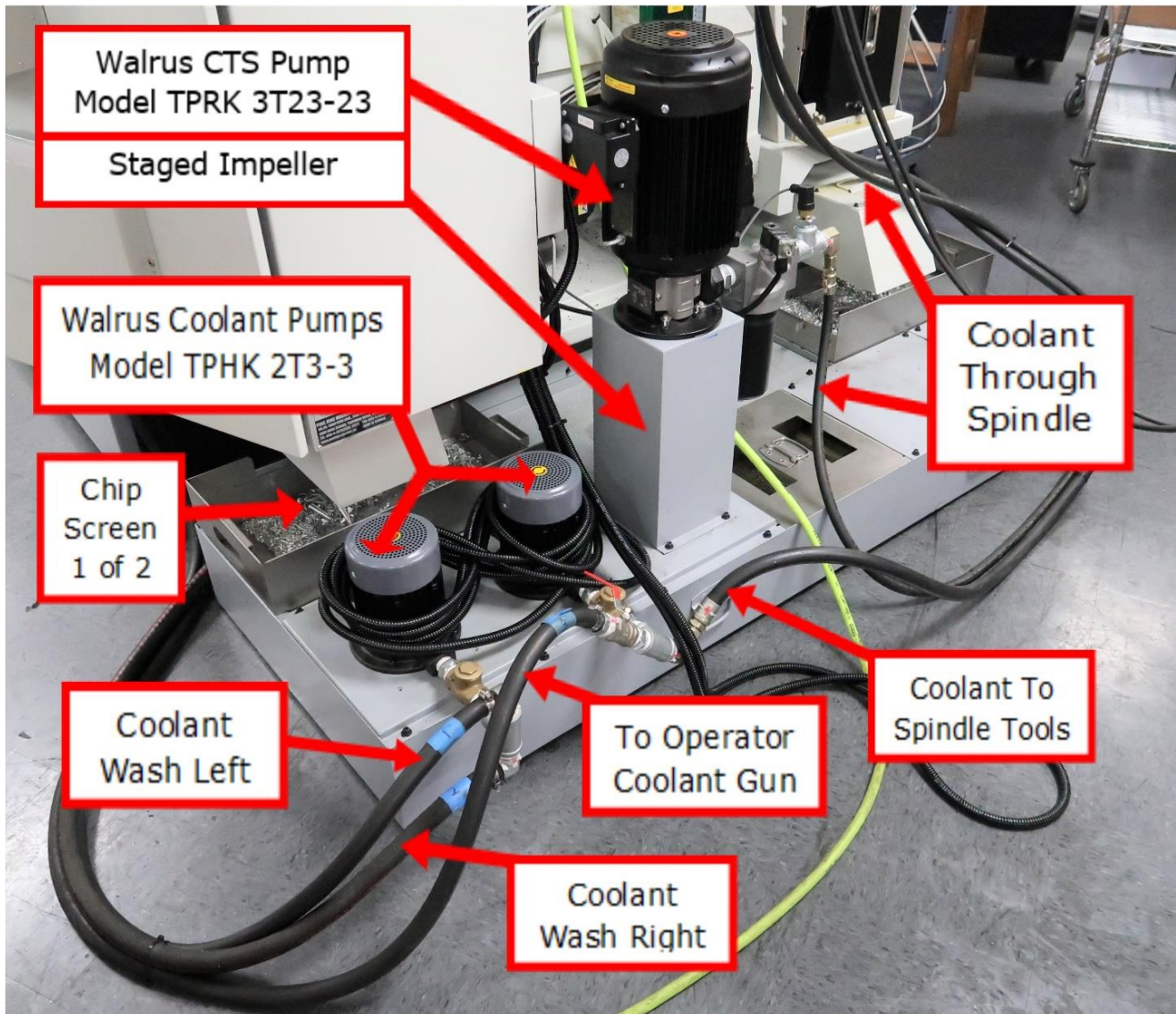

Figure 7.0 – Installed Coolant Through Spindle Option

7.1 CTS Sensors and Filter Location

CTS option has two sensors and a filter which could need service. Most likely item to service is the filter element. See figure 7.1 for the location of the Filter Clog Sensor, Coolant Pressure Sensor, and the Filter canister.

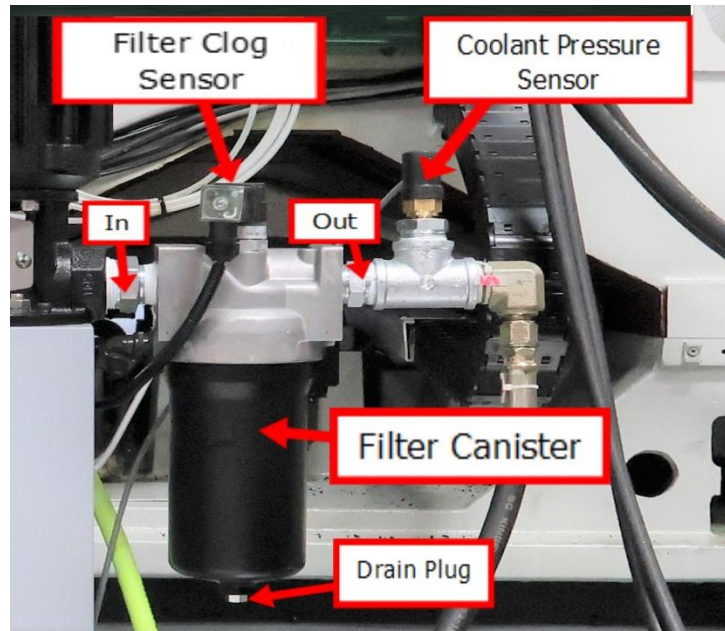

Figure 7.1 – Coolant Filter and Sensors

7.2 CTS Filter Clog Sensor Operation

The filter clog sensor is designed to detect when the filter canister is clogged and needs a replacement filter. The sensor detects a pressure differential between the fluid "In" pressure and the fluid "Out" pressure. If the pressure differential between "In" and "Out" is greater than 50 PSI, the sensor displays a warning message on the pendant. See figure 7.2

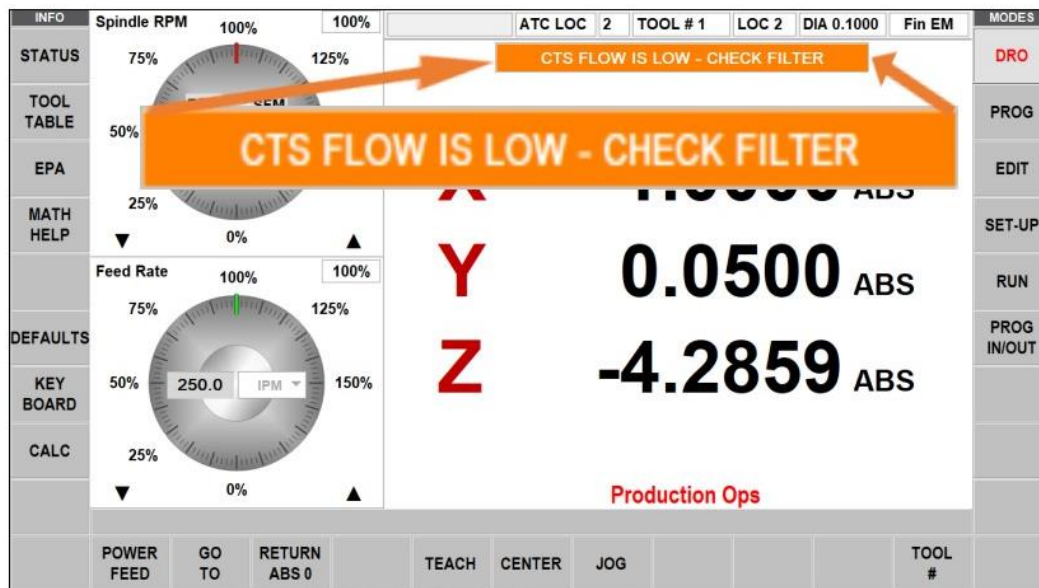

Figure 7.2 – Clogged Filter Error Message

7.3 CTS Filter Element Replacement

Steps needed for the replacement of the filter see figure 7.1 for its location:

1. Turn off system power.
2. Relieve any system pressure in the filter line.
3. Drain the filter canister by removing the drain plug. See figure 7.1
4. Loosen and remove canister using hex nut at the bottom of the canister.
5. Remove element by pulling downward with a slight twisting motion and either clean or replace the element. A replacement filter is available from SWI part number 31219.
6. Check canister O-ring and replace if needed. See figure 7.3
7. Lube element O-ring with petroleum jelly or light oil and place on post in filter head.
8. Install canister and tighten to 42 – 50 ft/lbs.
9. Confirm there are no leaks after powering the system.



Figure 7.3 – Filter Canister and Element

7.4 CTS Filter Clog Sensor Replacement

Steps needed for the replacement of the sensor see figure 7.1 for location:

1. Turn off fluid flow and turn off power to the TMC.
2. Remove Phillips screw holding connector to sensor and remove connector. Loosen the sensor with a wrench and remove.
3. Reverse above steps to replace and reconnect the sensor. Sensor is set from the factory and needs no calibration.

7.5 CTS Coolant Pressure Sensor

The coolant pressure sensor checks for proper coolant pressure in the spindle. The Coolant Pressure Sensor is designed to warn if there is insufficient pressure in the line. It monitors the coolant pressure in case of coolant runout or equipment failure. There is a warning message displayed on the pendant to give the operator a chance to correct the problem. If this warning message is triggered, the sensor halts the current program and stops the spindle. See figure 7.5

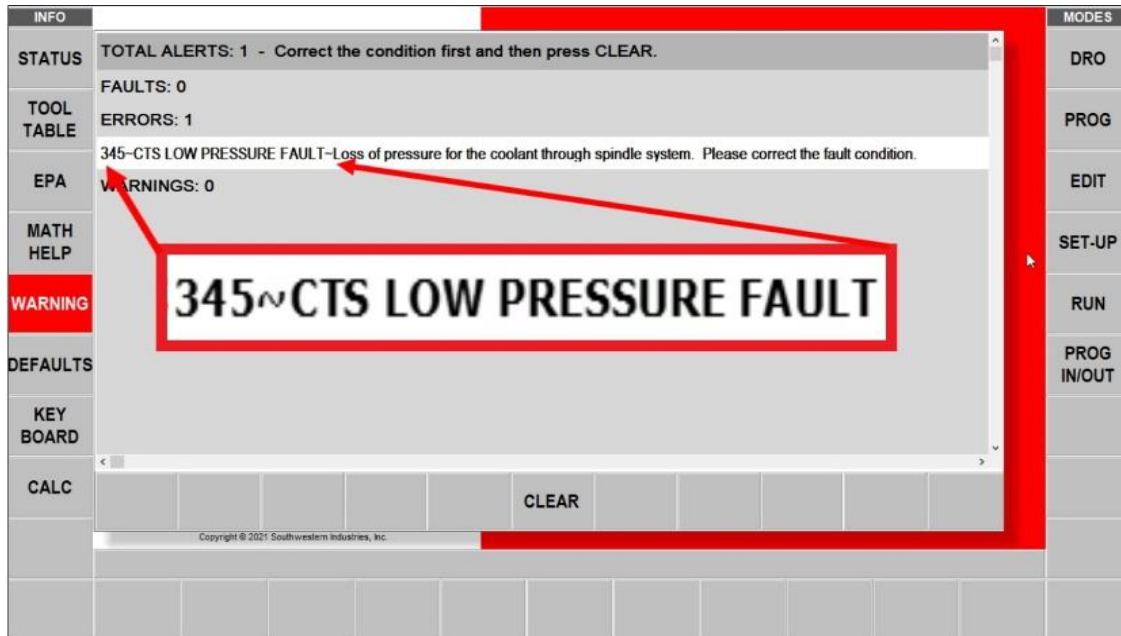

Figure 7.5 – Low Pressure Message

7.6 CTS Coolant Pressure Sensor Replacement and Calibration

Steps needed for the replacement and calibration of the sensor see figure 7.1 for location:

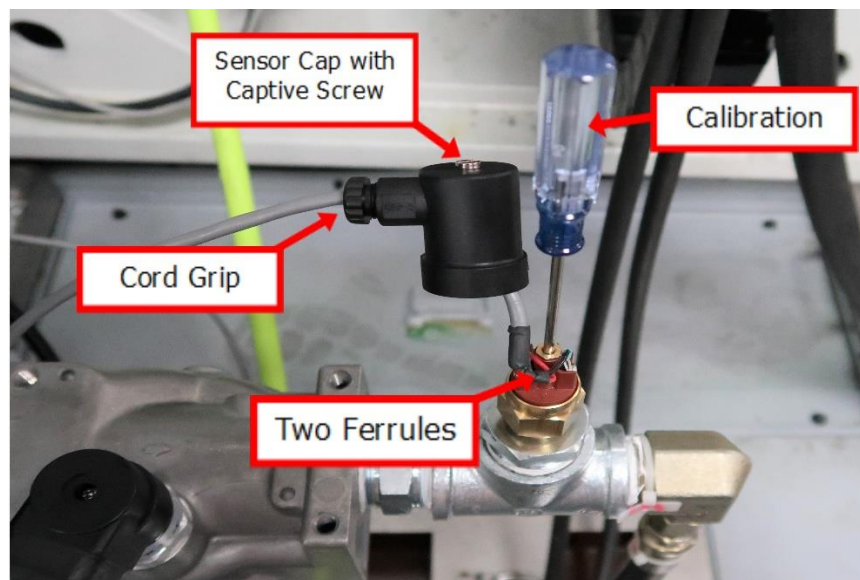

Figure 7.6 – Coolant Pressure Sensor

1. Turn off fluid flow using pendant button and turn off power to the TMC.
2. Loosen the slide cap and unscrew the captive screw at the top of the sensor. Now you can slide the cap out of the way. See figure 7.6
3. Disconnect two small electric ferrules on the sensor and remove the wires then loosen the sensor with a wrench. Replace the old sensor with the new one
4. Reverse above steps to reconnect the sensor.
5. If the spindle has a tool in it, remove it for calibration and power up the TMC turn on CTS at the pendant.
6. Note the adjustment screwdriver in the top center of the sensor for calibration. Use a flat blade to tighten this screw slowly, approximately 1/8th of a turn a second. When machine faults out, loosen the screw ¼ turn and clear the fault on the pendant.
7. Test CTS pump to make sure it comes on and operates for at least 10 seconds without faulting.

7.7 CTS Remove and Replace Pump

Steps needed for the replacement of the CTS Pump see figure 7.0 for location:

Warning!

Heavy object to be installed, proper safety precautions are needed.

1. Turn off CTS fluid flow at the pendant and turn off power to the TMC.
2. Drain enough coolant to clear the filter canister. Disconnect the wires going to Coolant Pressure Sensor connector (refer to section 7.6) and Filter Clog Sensor connector (refer to section 7.4). Disconnect power supply cover and cable from the motor. Protect the wires from fluid possibly coming from outlet hose. Disconnect filter hose.
3. The filter assembly (with sensors attached) can then be removed from pump outlet.
4. Remove four SHCS screws that bolt the motor to the sheet metal base. There are four nuts close by which connect to the internal impeller assembly, do not remove them. You want to remove the impeller with the motor.
5. This pump and impeller assembly weight about 100 lbs., use a proper lifting device for this step. Connect hoist to motor and lift off TMC. Slowly lift assembly from housing to let the impeller drain thoroughly. Set down in a safe manner.
6. Use the hoist, carefully guide the new motor assembly into position and reconnect the four SHCS.
7. Reconnect the electric supply cable with cover, filter assembly, filter outlet hose, and two sensors. The sensors do not need recalibration.
8. Power up the mill, turn on CTS at the pendant and test motor operation. Verify motor is turning in the correct direction with the arrows on top of the pump that indicate correct fan direction.

8.0 12K Spindle Option

8.1 12K Spindle Operation

The 12K spindle option is available to shops that need for higher spindle speeds for higher production rates and also for longer contour machining like that used in mold making. Shops may have a small ballnose endmill doing 3-axis movements for hours to create a smooth surface. Faster speeds mean then can keep feeds high and still reach the necessary finish requirements.

Whatever the reason TRAK provides a heavy-duty system providing extra speed and cooling inside the spindle right at the work surface.



Figure 8.1a – Heat Exchanger

The 12K RPM spindle option requires many parts to be changed when compared to the standard 8K spindle. Due to the substantial increase in speed and expected heat generation from increased production capabilities, the TMC requires an additional cooling system for the spindle. Figure 8.1a shows the heat exchanger installed on the rear of a TMC.

The oil circulation system works all the time the mill is powered up. The spindle could be used at any time, so the extra lubrication is always available. Circulation oil flows through the spindle out to a heat

exchanger that contains a reserve tank, radiator and a pump to keep the fluid in circulation. Pressurized hoses provide the transfer of fluid from the heat exchanger to the spindle as well as the return trip. Dual cooling fans cool fluid in the radiator and also cool the pump motor. A gauge on the heat exchange monitors coolant level. It is easy to view the coolant level from the rear of the TMC. See figures 8.1b and 8.4

Spindle manufacturer recommends using a stepped approach when using higher spindle speeds, i.e., to reach 12K operation, start at 3K, 6K, 9K, and then to 12K. There is no need for routine maintenance other than checking fluid level. Sheet metal covers are easy to remove in case the exchanger develops a leak or needs other servicing.

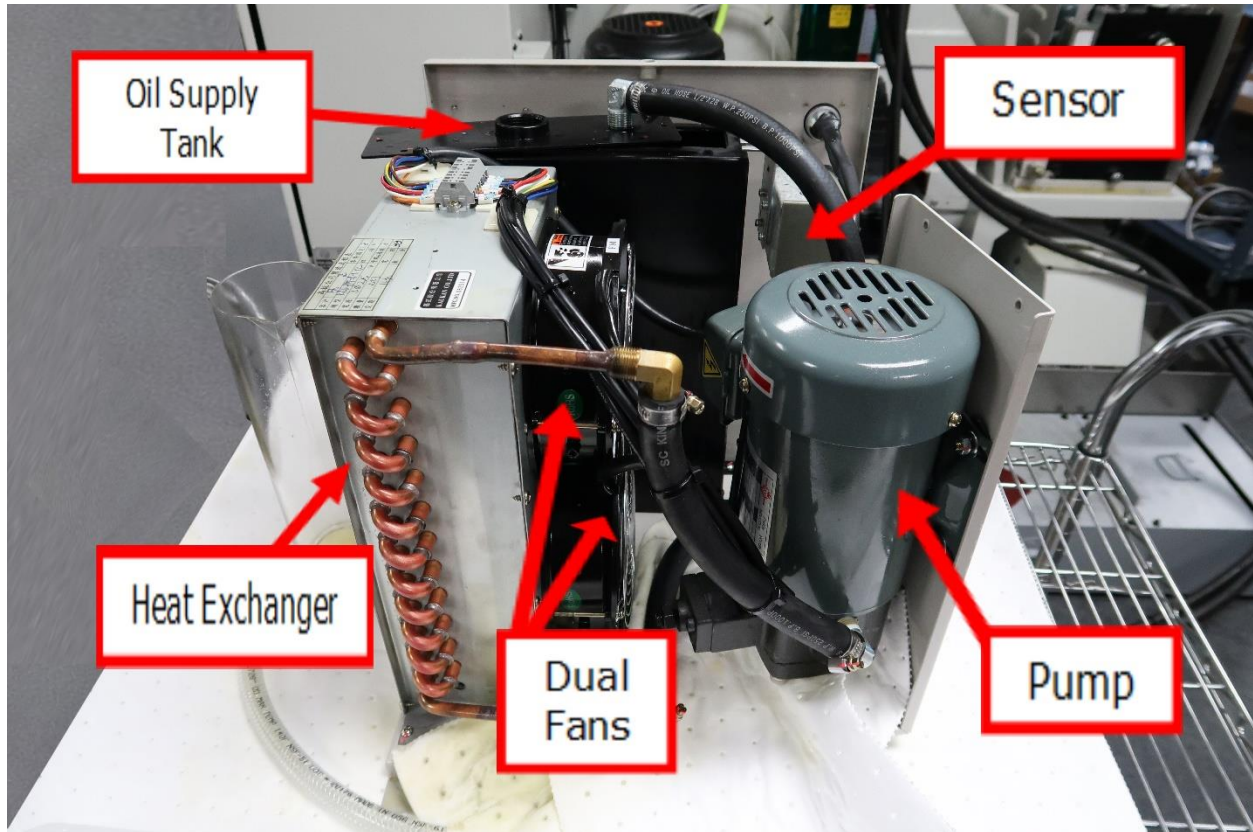

Figure 8.1b – Heat Exchanger Without Covers

8.2 Added Spindle Oil Circulation With 12K Option

Figure 8.2 shows the spindle cartridge a couple of layers below the normal installed view. The spindle sheet metal covers have been removed and the inset photo shows the spindle cartridge outside of the casting. To the right of the photo, you see the high-pressure circulation oil lines supplying the fluid to the spindle as well as the return pressure line. To the left of the photo the inset detail shows the spindle cartridge out of the casting and allows clear view of the areas in the spindle that get the additional cooling from the 12K option.

An oil passage is drilled into the flange above the spindle nose to allow the circulation oil access to the spindle nose. This provides new paths for cooling in the area immediately adjacent to the tool and the main source of generated heat. The pressurized circulation oil is forced through the nose then up back above the flange and around the spindle shaft. There the oil scrolls upward along the circumference of

the shaft along oil channels before exiting the spindle heading back to cool off in the heat exchanger. This additional cooling allows the customer increased production.

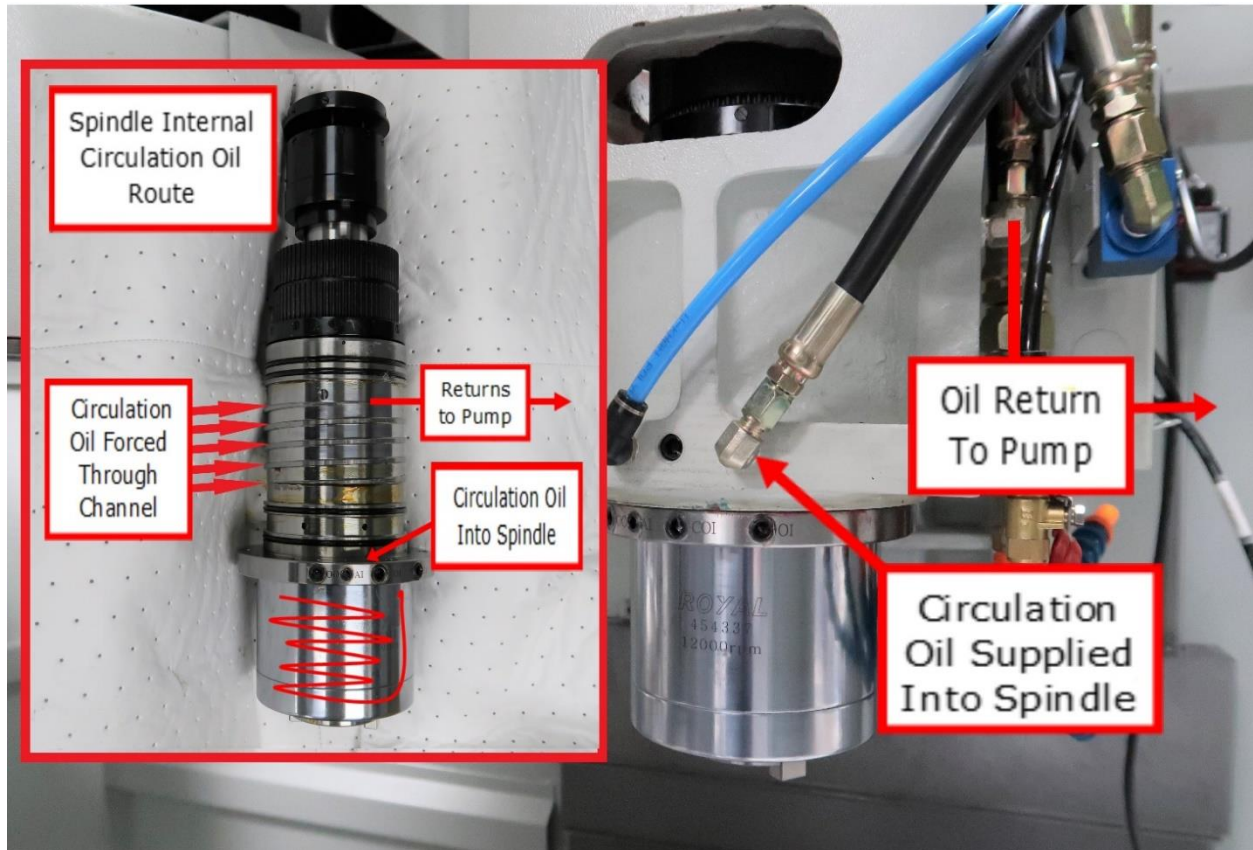

Figure 8.2 – Spindle Circulation Oil Path

8.3 12K Spindle Maximum Spindle Torque & HP

The following graphs illustrate the continuous and peak torque vs RPM (figure 8.3a) and horsepower vs RPM (figure 8.3b) for the TMC machine at the spindle. Peak torque and horsepower values can only be attained for a short period of time before the spindle drive will fault out to protect the motor.

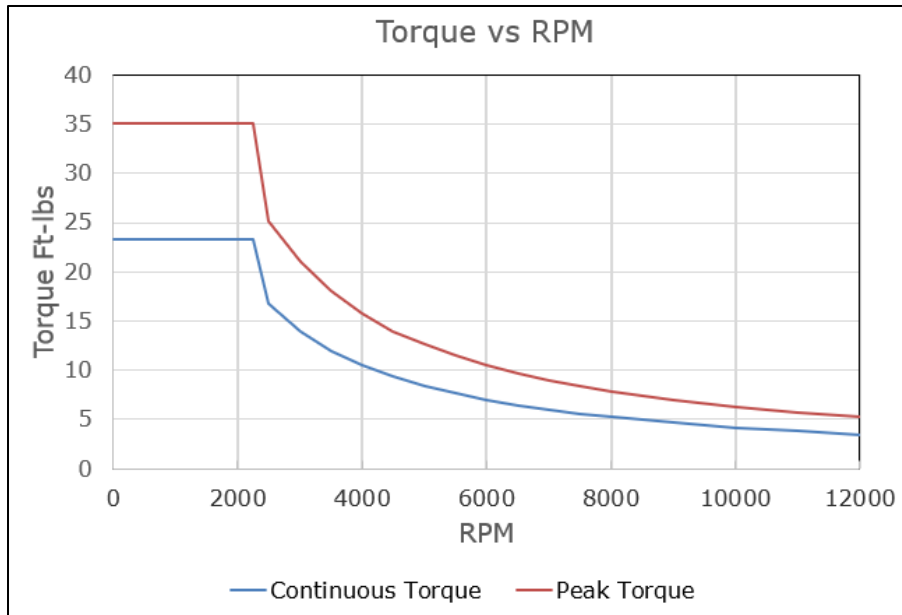

Figure 8.3a – Peak Torque vs RPM

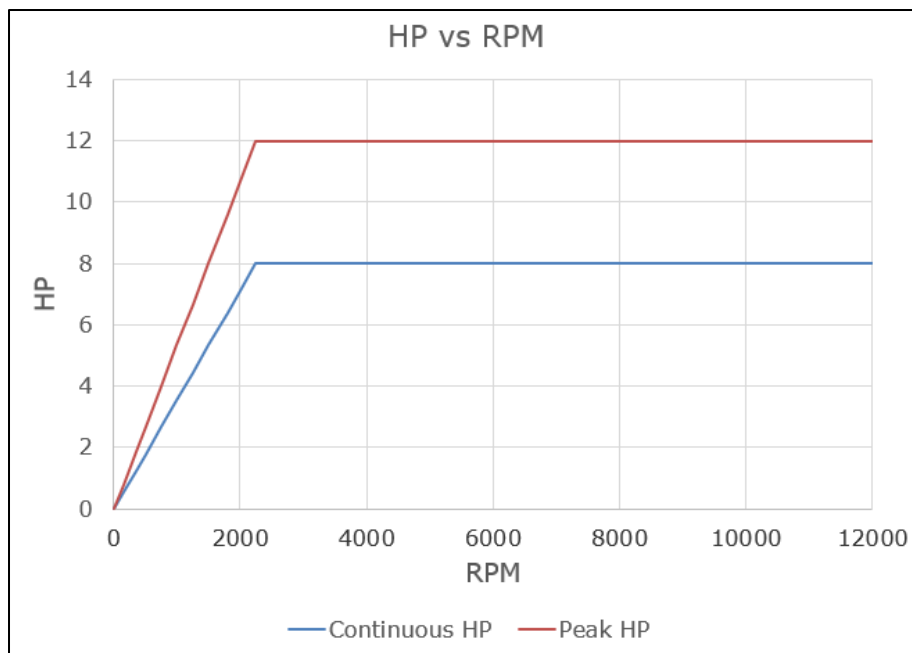

Figure 8.3b – Horsepower vs RPM

8.4 12K Maintenance and Adding Oil

Other than routine checking for leaks or replacing damaged spindle cooler oil lines, the only maintenance is to change or add oil. There is a drain plug at the bottom of the front panel and a gauge showing the internal oil level as shown in figure 8.4, the Kaukan pump mounted on the rear of the mill. It is simple to remove the drain plug to remove the old oil and reattach the drain plug. You will need to remove the top cover in order to add oil, refer to figure 8.1b to see the oil supply tank and where to add oil.

Because of the system design, some of the oil supply hoses are above the level of the pump, so when turned off some oil will drain back to the pump. Add oil carefully and when you have filled the supply tank to about $\frac{3}{4}$ capacity, replace the cap and operate the pump. Add oil until the gauge level shows close to the black and red indicator at the top of the gauge while operating. There is space in the tank to allow for some oil to return to the pump when the pump is not operational.



Figure 8.4 – Kaukan Front Panel

8.4.1 Oil Type and System Maintenance Intervals

TRAK recommended oil: Quality ISO 32 oil, Anti-Wear additive.

- Weekly service is to check oil level and inspect for leaks.
- Monthly service is to clean air filter and blow out heat exchanger.
- Annual service to change the circulation oil.

8.5 Spindle Warm Up Procedure

Recommended 12K TMC Start-up Procedure for different conditions:

Situation	Spindle Speed (RPM)	Time (min)
Daily warm up	3000	5
	6000	5
	9000	5
	12000	5
Spindle idle for over 48 hours	3000	10
	6000	10
	9000	5
	12000	5
Spindle idle for over 2 weeks	3000	15
	6000	15
	9000	15
	12000	15

8.6 12K Warning Message

The pressure sensor monitors oil pressure in the heat exchanger. A message may be received by the control software to notify the operator of a potential problem. This message will flash on the screen as a warning. This message does not stop normal mill operation, it is left to the operator to correct the situation. See figure 8.6

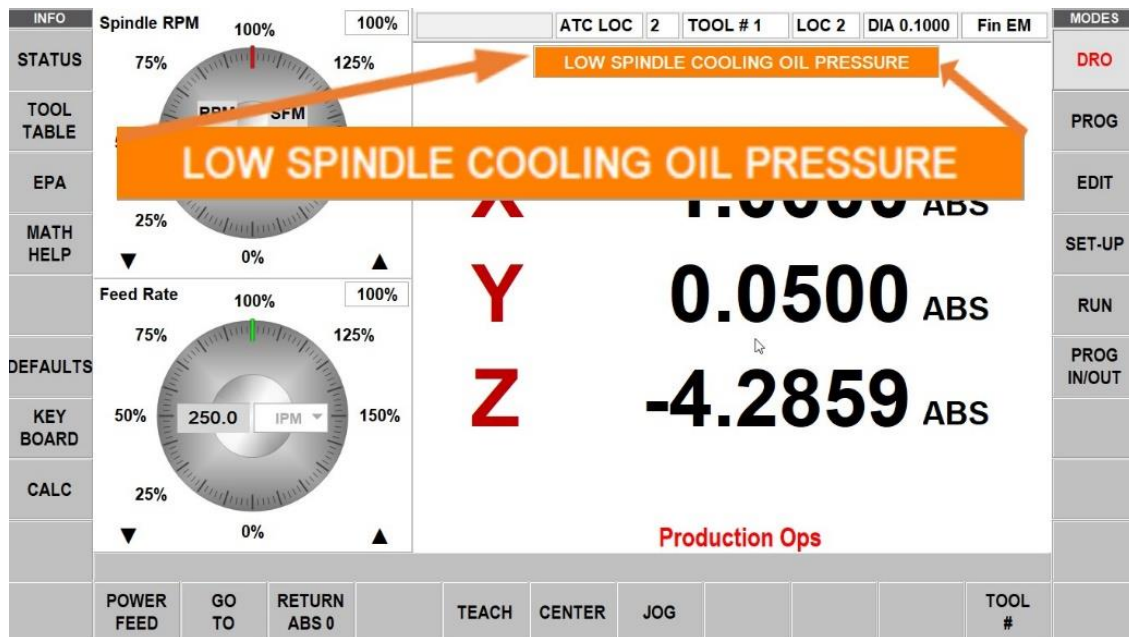



Figure 8.6 – Low Spindle Coolant Warning

8.7 Installation Checklist of 12K with CTS

Use this checklist to assure a complete installation of these options on a TMC.

12K with CTS Installation Checklist	
<input type="checkbox"/>	1. Initial Checks: Verify the pendant software is version 2.4.0 or later. Run Service Code 142 to save machine's configuration to USB flash drive.
<input type="checkbox"/>	2. Disassemble Head Sheet Metal Air & Cables Piston hardware Piston tower assembly (remove bolt) Remove struts
<input type="checkbox"/>	3. Pull Spindle Loosen and remove belt tensioners Loosen motor base to loosen belt Install tooling to table Loosen flange bolts Lower spindle into tooling  <p>Use Jackscrews, raise ram, remove spindle</p>

12K with CTS Installation Checklist

- 4. Install Spindle with CARE (Caution with outside surface and spindle top plate)



Set on tooling
Grease spindle o-runs, Caution don't block oil passage

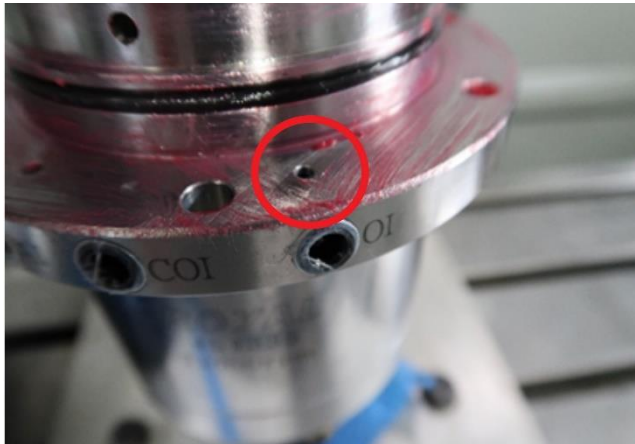

Check O-rings
Lower ram
Secure bolts & torque
Belt swap
Tensioners install, tension belt



12K with CTS Installation Checklist

- 5. Rebuild top end
Struts
Bolt into piston & clamp tower
Remount piston

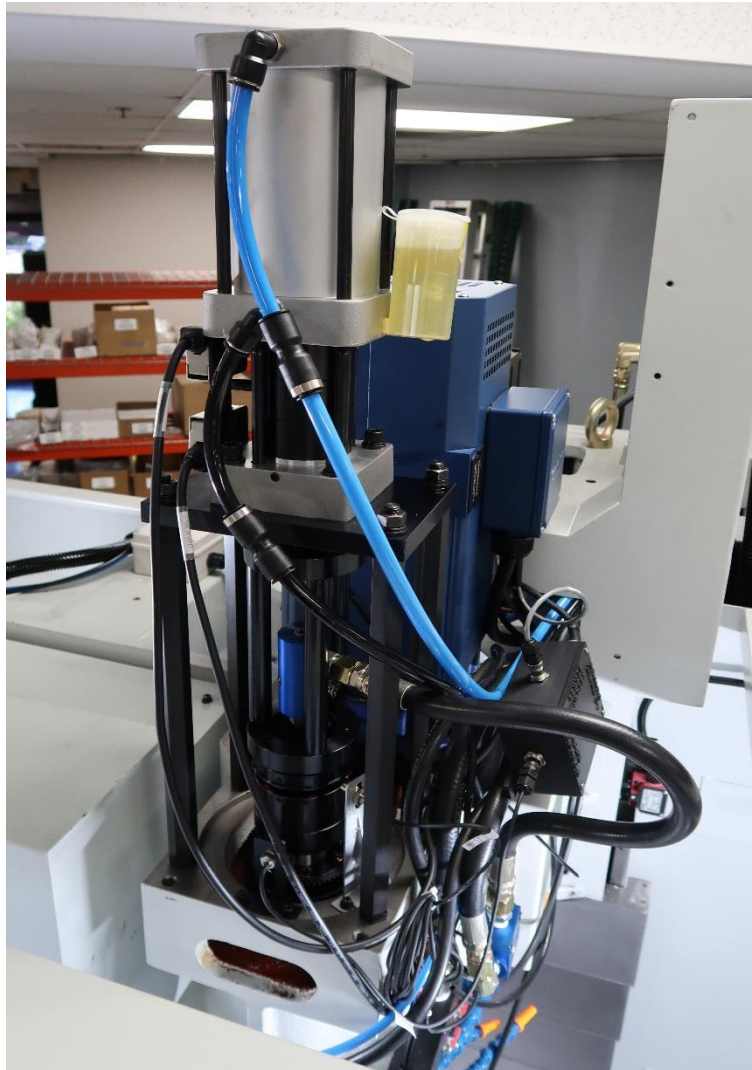

- 6. Mount 12K support base and unit



12K with CTS Installation Checklist

- 7. Knockout plate
Install pump riser & pump
Install fittings, filter, sensors

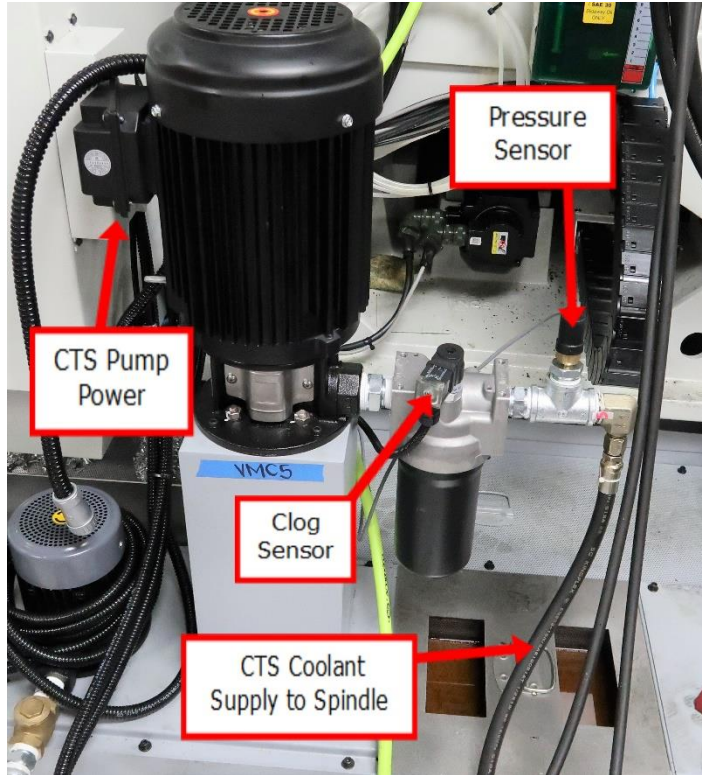

- 8. Electrical Components
Breakers & wires
Contactor, suppressor overload, sensors & lines

- 9. Run Wires
Oil cooler
31690 12K module
Pump, filter clog and coolant pressure sensors

12K with CTS Installation Checklist

- 10. Run Hoses
Oil cooler
Coolant

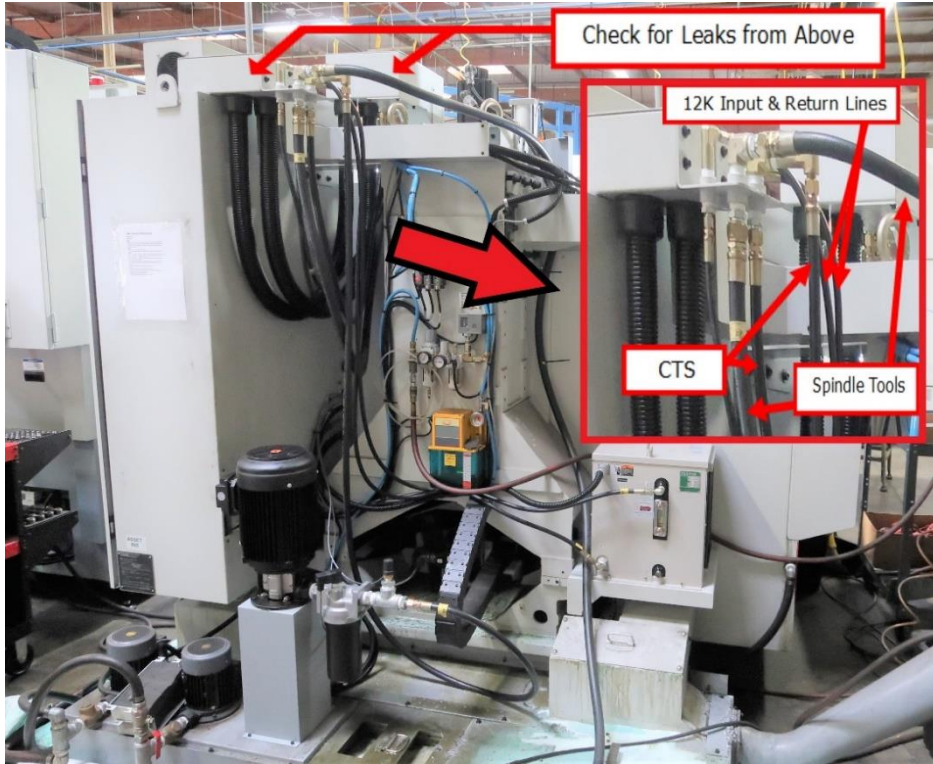

- 11. Software Update
AC drive
Machine ID key
Service Code 541
Option key
ATC length & orientation sensor

- 12. Operation Checks
ATC test – Run Tool Changer Test Program.PT10 - takes about 6 minutes
Fill 12K cooler, prime, refill
Check 12K cooler flow, leaks, run 10 minutes
Spindle head test
Run spindle at: 3000, 6000, 9000, 12000 RPM for 5 minutes each.
Run spindle at 500 RPM increments up to 12,000 for a few seconds per increment.
Please note any of the following: Head noise, excessive heat on spindle, vibration, spindle fan noise.
Coolant tank filled
Close doors/windows, run open spindle no tool holder, check for leaks 15 minutes
Make sure CTS pump rotates in the correct direction (counterclockwise).
Set coolant pressure sensor

- 13. Reassemble sheet metal

- 14. Run Service Code 141 to load the new configuration back into spindle

9.0 Probe Part Option

TRAK manufactures a Part Probe option that can be retro-fitted onto a TRAK TMC at any time after its initial purchase. See figure below.

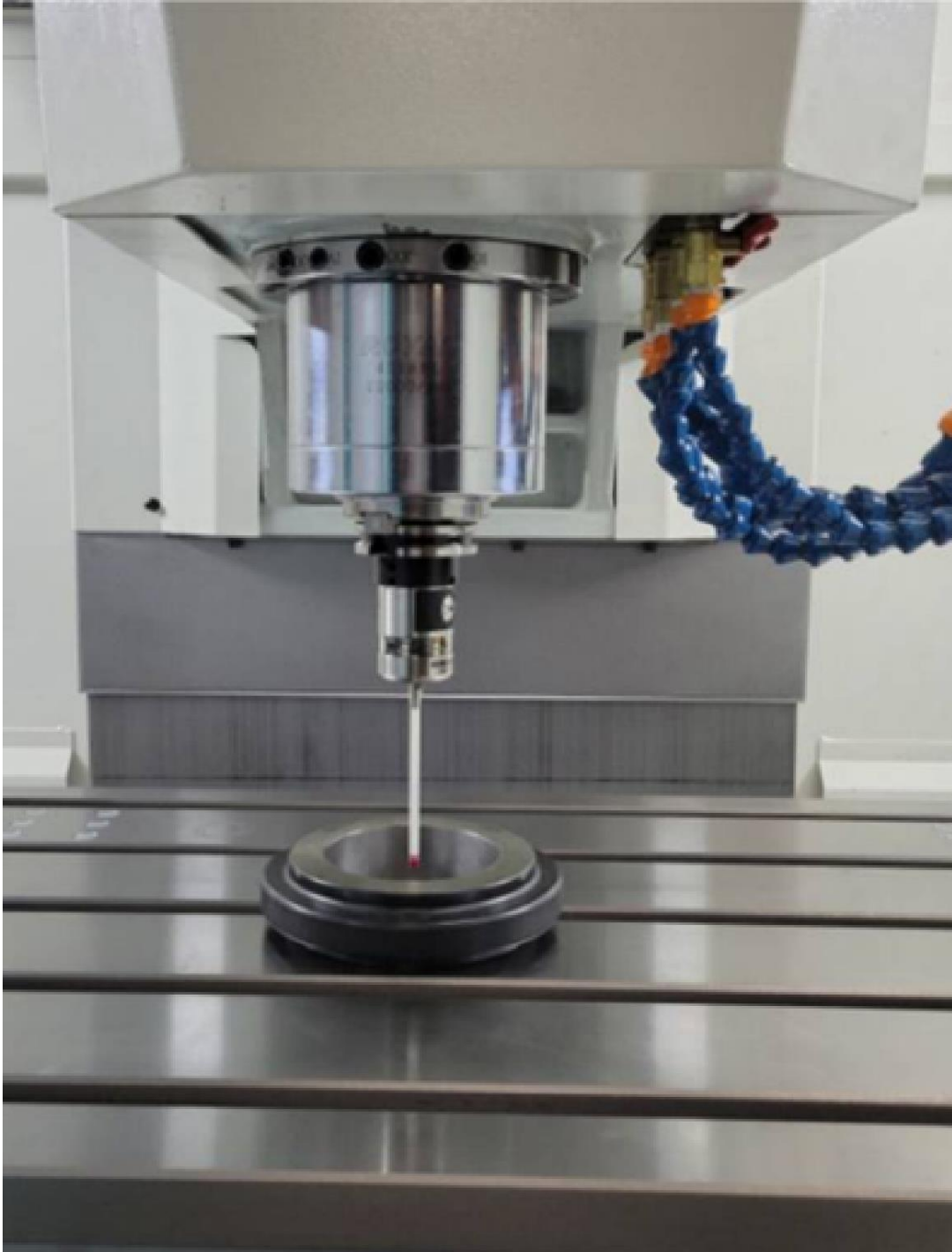

Figure 9.0.1 – Optical Work Piece Probe



Figure 9.0.2 – Optical Receiver

9.1 Service Codes: Probe Part

The following service codes are specific to the Part Probe option.

9.1.1 Code 124: Probe Part calibration

Used to calibrate the probe.

9.2 Probe Calibration Procedure

1. First complete XYZ laser calibration and backlash adjustments before starting with the probe. Confirm service codes 123 and 128 have been performed.
2. Here are a few things to ensure:
 - Set the machine to metric mode.
 - Confirm the machine is in PRODUCTION OPS mode.
 - When running the Service Code, do not lower the feed rate override. Keep it at 100%.
 - Always run the Service Code with the door closed.
 - Ensure the probe is inserted in the same orientation (relative to the spindle dogs) each time. This is important because the calibration values vary based on the angle at which the probe triggers. Calibrating in one orientation and measuring in another will result in significant inaccuracies.
3. To calibrate the probe, both the probe and optical receiver need to be set up, and the ring gauge and dial indicator must be present.
4. Put the probe in the spindle and use a dial indicator mounted on the table to check the run-out of the ruby tip. Use the lower 4 set screws to get the runout to be .0001 in. or less. DO THIS WITH a non-probe tool indicated on the DRO screen. This way, the machine will not trigger the probe which confuses this process. Also, use the first .001" or .002" of travel on the indicator to avoid deflecting the probe during this process. When done, switch back specifying the Probe tool in DRO.
5. While the indicator is still on the tip, push on the lower portion of the probe tool (not the stylus, but the section where the LEDs are) (As shown in figure 9.2.1 below). You will see the indicator will deflect. It must return (spring back to) zero run-out. Test this in various directions. If it doesn't consistently return to zero run-out, you must fix this first. The probe assembly may be loose in the tool holder or the other set screws are not properly tightened. If you don't remedy this, all other work is futile because the probe will change position (and negate any calibration) when the tool is handled.



Figure 9.2.1 – Lower portion of the probe

6. Put the ring gage on the floor of the vise and tighten it just finger tight... 10 in-lbs. Use a dial indicator on the spindle to get XY perfectly in the center of the gage. It should be .0001in or less. Set X and Y zeros here.
7. Proceed to calibration of XY using SC 124. Determine the exact ring gage size to .001 mm. It should be stated on the ring gage. Use the nominal stylus diameter of 6.000 mm (Do not micrometer it... use 6.000)
8. Make sure the machine is in PRODUCTION mode and the tool in the spindle is a PROBE (on the DRO). The spindle will orient when doing the calibration program. If it isn't in PRODUCTION mode, you will get a fault.
9. After completing this, save the values as offered by the service code. We have a sanity check on the 12 values measured (at 30-degree intervals). They must be between .001 and .200 mm. If the runout is bad on the probe tip, or the XY zero is not set at the exact center of the ring gage, this check will fail.
10. For Z, go back to DRO. Get a plastic shim about .010 inches. Micrometer it in the middle, not on the edge where there may be a burr. Bring down Z to a smooth surface such as the top of the table, vise or 1-2-3 block. Use the shim to get the probe tip just above the surface by the thickness of the shim. If you can feel any drag on the shim, go higher. Set Z zero here. Adjust the Z in 0.0001" increments when trying to be just above the shim or gage block. Note – if you do not have a shim, you can use a gage block or 123 block.
11. One tenth or two tenths too high is fine. One or two tenths too low will cause the calibration to fail. The probe nominally triggers at about .005 to .020 mm in Z. This is what the calibration procedure is trying to measure. We have a sanity check on the values. They must be between .005 and .200 mm.
12. Move the head up about 6mm or .25 in. Go to Service Code 124 and run the Z- calibration. Monitor Z on the DRO and mentally note the lowest number you see. If it isn't a negative number, the calibration will surely fail the sanity check.

13. Save the Z-values.
14. To test calibration, go to DRO and do the CENTER/CIRCLE function a few times. Use a dial indicator to check the center location after moving to zero. It should be within about .003 microns or .0001in or .0002in depending on how accurately you did the above procedure.
15. Check the Z calibration by putting a dial indicator on spindle base. Use the probe to touch the top of the table or gage block. Set the dial indicator so it also touches the top of the table or gage block. Go up and down in Z and probe the tabletop with the probe. The dial indicator should be repeating to better than .005 mm or 0.0002”.



Figure 9.2.2 – Calibration check using dial indicator on spindle base

Note that any error in the calibration will be represented in every measurement you make after this while using it.

And, also, if you have another probe nearby (like within a few meters) and it can "see" the probe transceiver mounted in the machine, you will get probe errors which the software should detect and display on Warnings screen.

10.0 Introduction to Self-Service

The objective of this section of the manual is to allow the user of the ProtoTRAK Control to resolve the majority of potential service problems.

This manual assumes that the user is not experienced with CNC troubleshooting and repairs. Special tools are not required for the procedures described in the manual.

Please see Section 3 for basic troubleshooting sections of the manual.

10.1 When You Have a Service Problem

SWI recommends that you consult this manual or our web site first. We also have a Dozuki site with detailed troubleshooting procedures <https://trakmtsupport.dozuki.com/>. Often it will be possible for you to resolve the problem yourself or isolate the problem to a particular cause.

Your next step is to contact the SWI Customer Service Group for assistance.

10.1.1 Communication with the SWI Customer Service Group

SWI Service Department Direct Line: (800) 367-3165

Web Address: www.trakmt.com

This phone line rings directly into the SWI Customer Service Group. If a Customer Service Representative (CSR) is not available within the first few of minutes, your call is transferred into our voice mail system.

Our voice mail is continuously monitored. If you have an emergency, indicate this in your message. Our Service Voice Mail box number is 555.

SWI Service Department Direct Fax Number: (310) 886-8029

Customer Service Group Hours: Monday - Friday 7:00 AM to 4:30 PM Pacific Time.
(SWI observes a normal holiday schedule)

10.2 Replacements

10.2.1 Exchange Program

SWI keeps in stock the major subassemblies required to resolve service problems. With very few exceptions, the part needed to resolve any given service problem is on the shelf and ready to ship. A little bit of troubleshooting on your part means that we can get the right part to you fast.

After replacing the failed unit with the replacement unit, simply put the failed unit in the same box that the replacement part came in and ship it back to us via UPS ground service.

This unique Exchange program gives our customers access to refurbished "like-new" subassemblies that have been brought up to current design revisions and go through the same QC procedures as our new products. These high-quality replacement units are available at a fraction of the price of a new subassembly.

10.2.2 Return Material Authorization (RMA) Number

All shipments of replacement parts are accomplished through our Return Material Authorization (RMA) system. At the same time the CSR is diagnosing the problem and ordering the part, they will issue an RMA number that will allow us to efficiently process the return part.

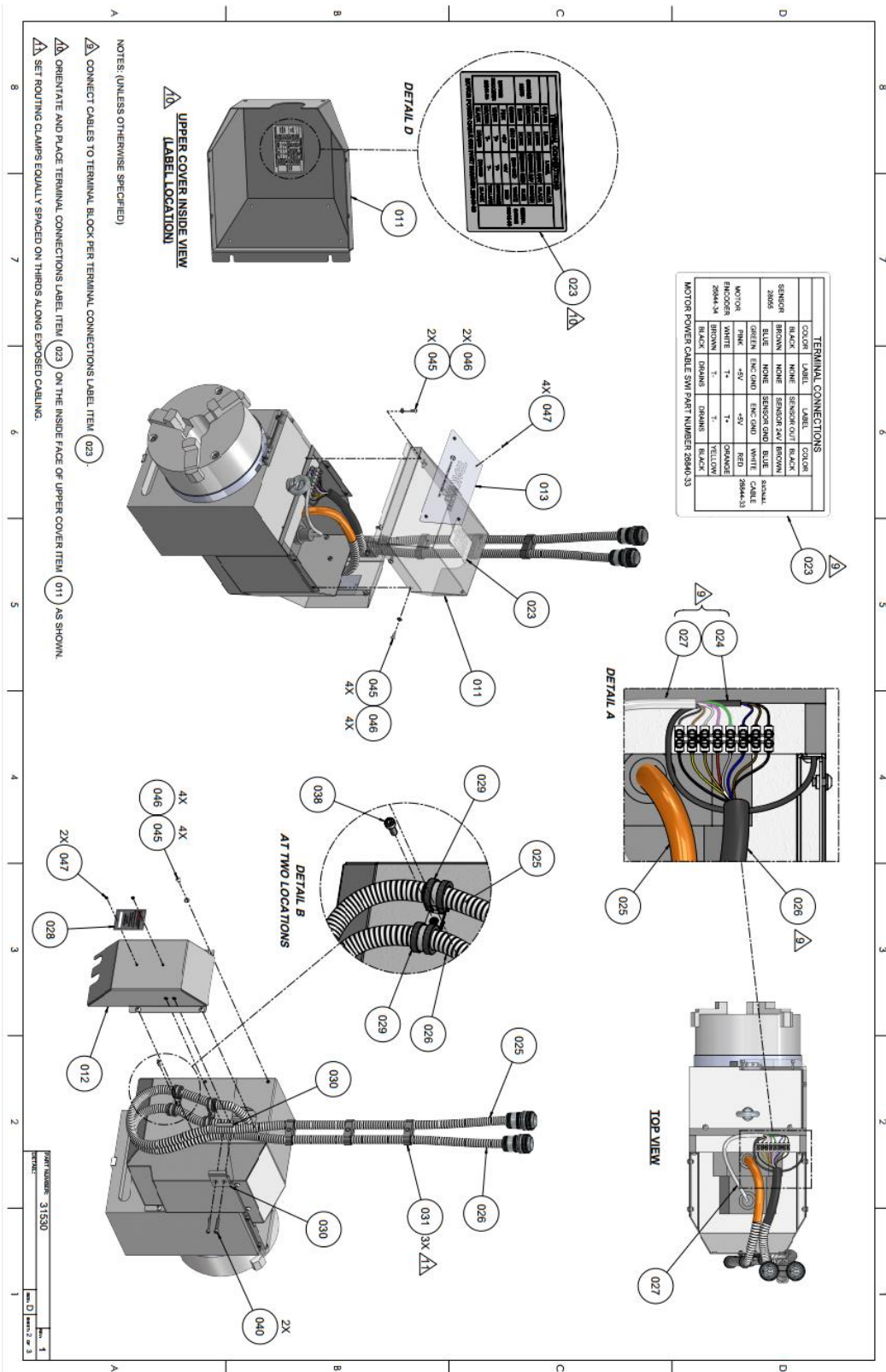

Item No.	Part Number	Description	Detail	Type	QTY.	Who	Category	MFG Part Number	Manufacturer
001	28050	BASE-MACHINED-4TH AXIS-SWI		Normal	1		Manufactured		
002	28056-1	CYCLICAL DRIVE ASSY-MOD-4TH AXIS-VMC		Normal	1		Purchased	FCIS-A35-89	Suntlino
003	28164-6	MOTOR-AXIS-XI-VMC		Normal	1		Purchased	EMAE-E21310RS	Delta
004	28081	BLOCK-HOME INDICATOR-4TH AXIS-SWI		Normal	1		Manufactured		
005	28057	ADAPTER PLATE-8" CHUCK-SWI 4TH AXIS		Normal	1		Manufactured		
006	27062-2	CHUCK-3 JAW-4TH AXIS-VMC-8 INCH-MANUAL		Normal	1		Purchased		
007	28054	BLOCK-HOME SENSOR-4TH AXIS-SWI		Normal	1		Manufactured		
008	28053	BLOCK-CABLE GUARD-4TH AXIS-SWI		Normal	1		Manufactured		
009	28058	KEY-BASE-4TH AXIS-SWI		Normal	1		Manufactured		
010	31534	SHEETMETAL-ASSY-LOWER-4TH AXIS		Normal	1		Purchased		
011	31535	SHEETMETAL-ASSY-UPPER-4TH AXIS		Normal	1		Purchased		
012	31532	SHEETMETAL-ASSY-COVER-REAR-4TH AXIS		Normal	1		Purchased		
013	31542	NAMEPLATE-BRANDING-4TH AXIS		Normal	1		Purchased		
014	28082-1	TERMINAL BLOCK-8MM EURO STRIP-WIRE GUARD-8 POS		Normal	1		Purchased	ES0800/0805FB	On-Shore Technology, Inc
015	27669-1	GASKET-BEZEL-ROLL		Normal	1		Purchased	7401-A-1/8 X 1/2 X 50"	-1
016	27056	BOLT-EYE-EM10		Normal	1		Purchased	205X38N70	Grotratt Rubber Products Co. Inc
017	27805-11	O-RING-211 OD X 206 ID X 3 THK		Normal	1		Purchased		
018	27805-13	O-RING-1.745 OD X .725 ID X .210 THK-AS568A 314		Normal	1		Purchased		
019	27805-12	O-RING-ID 103MM W 2.5MM		Normal	1		Manufactured		
020	27805-9	O-RING-3.129 OD X 2.989 ID X .070 THK-AS568A 041		Normal	1		Manufactured		
021	27805-8	O-RING-.566 OD X .426 ID X .070 THK-AS568A 013		Normal	6		Manufactured		
022	27805-10	O-RING-4.693 OD X 4.487 ID X .103 THK-AS568A 157		Normal	1		Manufactured		
023	31530-LB1	LABEL-TEXT-4TH AXIS-TMC		Normal	1		Purchased		
024	28055	CABLE ASSY-SWITCH ASSY-SENSOR-PROXIMITY-4TH AXIS-SWI		Normal	1		Manufactured		
025	26940-33	CABLE ASSY-MOTOR POWER-4TH AXIS		Normal	1		Manufactured		
026	26944-33	CABLE ASSY-4TH AXIS SIGNAL ARMOR CABLE		Normal	1		Manufactured		
027	26944-34	CABLE ASSY-ENCODER CABLE-4TH AXIS		Normal	1		Manufactured		
028	21934	NAMEPLATE-SYSTEM SN		Normal	1		Manufactured		
029	22636-4	CLAMP-CABLE-58 ID-RUBBER-STEEL-LOOP		Normal	4		Purchased		
030	31532-2	CLAMP-4TH AXIS		Normal	2		Manufactured		
031	31536-1	CLAMP-ROUTING-625ID-MOD		Normal	3		Manufactured		
032	14 792	WASHER-ENDER-STL-ZINC	1/4 ID X 1.0 OD X .055 THK	Normal	1		Purchased		
033	M6 (738)	WASHER-SPLIT LOCK-STL-BO		Normal	1		Purchased		
034	M10-1.5X12 41B	SCREW-SOC SET-STL-BO-FLAT		Normal	2		Purchased		
035	M6-1.0X20 (25B)	SCREW-SHCS-STL-BO		Normal	1		Purchased		
036	28081	SCREW-SHCS-M10-1.5X80-25B-SEALING		Normal	6		Purchased		
037	28075	CAP-SHCS-M10		Normal	6		Purchased		
038	10-32X12 (25B)	SCREW-SHCS-STL-BO		Normal	5		Purchased	FCM10	KO
039	M10-1.5X30 (25B)	SCREW-SHCS-STL-BO		Normal	6		Purchased		
040	10-32X1 (25B)	SCREW-SHCS-STL-BO		Normal	6		Purchased		
041	10-32X36 (25B)	SCREW-SHCS-STL-BO		Normal	4		Purchased		
042	4-40X9/16 (25B)	SCREW-SHCS-STL-BO		Normal	2		Purchased		
043	M6-1.25X25 (25B)	SCREW-SHCS-STL-BO		Normal	2		Purchased		
044	24009-1	WASHER-BELLE-VILLE SPRING LK-SERRATED		Normal	4		Purchased	WSPFST1031ND51PL031S	ATLAS BOLT
045	10-32X36 (27B)	SCREW-SHCS-STL-BO	331 ID X .512 OD X .028 THK-5/16 OR M8	Normal	4		Purchased		
046	M6 (71B)	WASHER-FLAT SAE-STL-BO		Normal	14		Purchased		
047	AD-3-ABS	RIVET-POP-MILL FINISH		Normal	6		Purchased		

PRODUCTS USED ON:

REV: 1 SHEET: 3 OF 3

PART NUMBER: 31530
 DRAWN BY: DH 7/27/2020
 ENGINEER: DH 7/27/2020

11.2 Drawing 31538 – 4th Axis Option

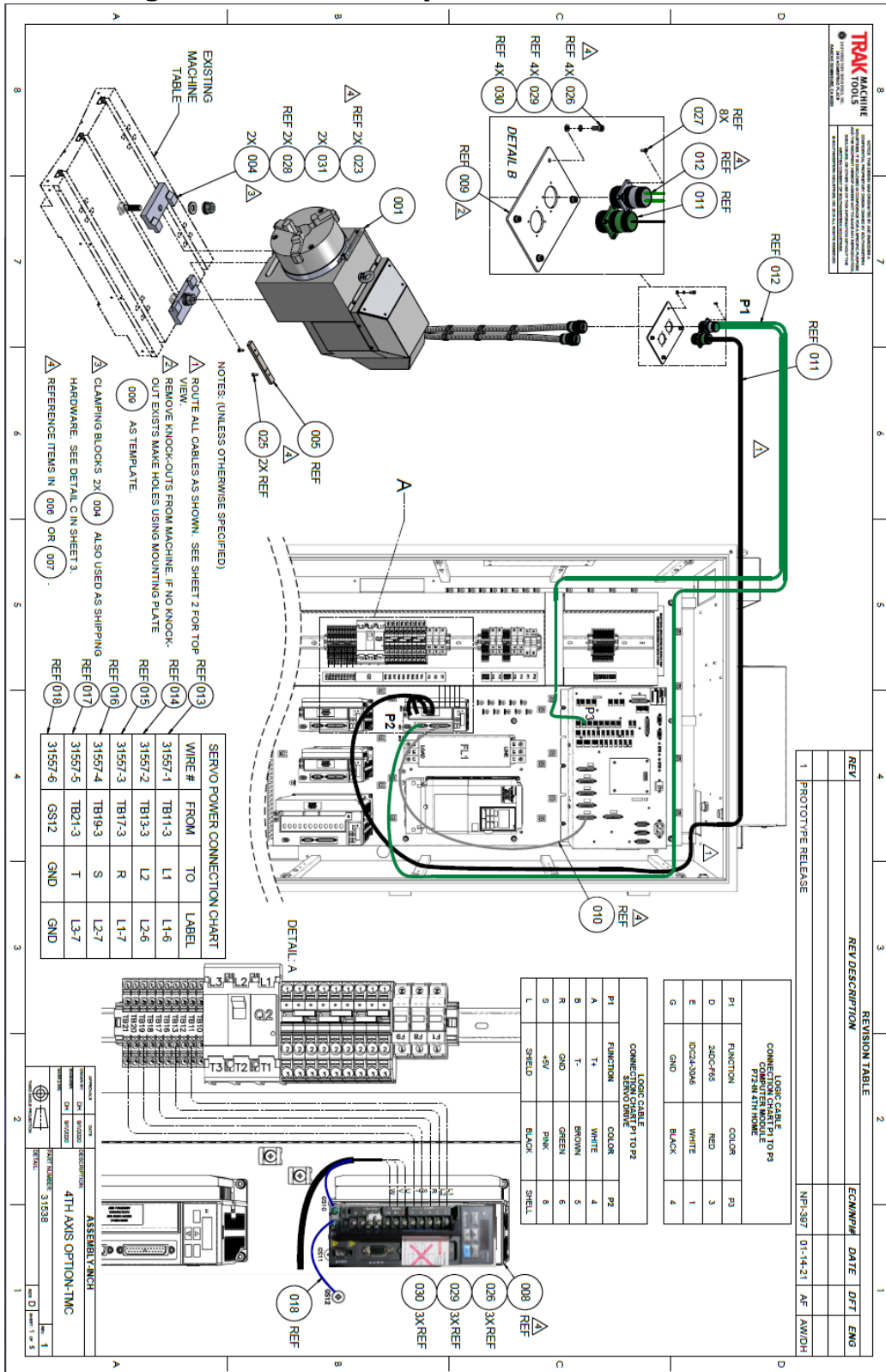

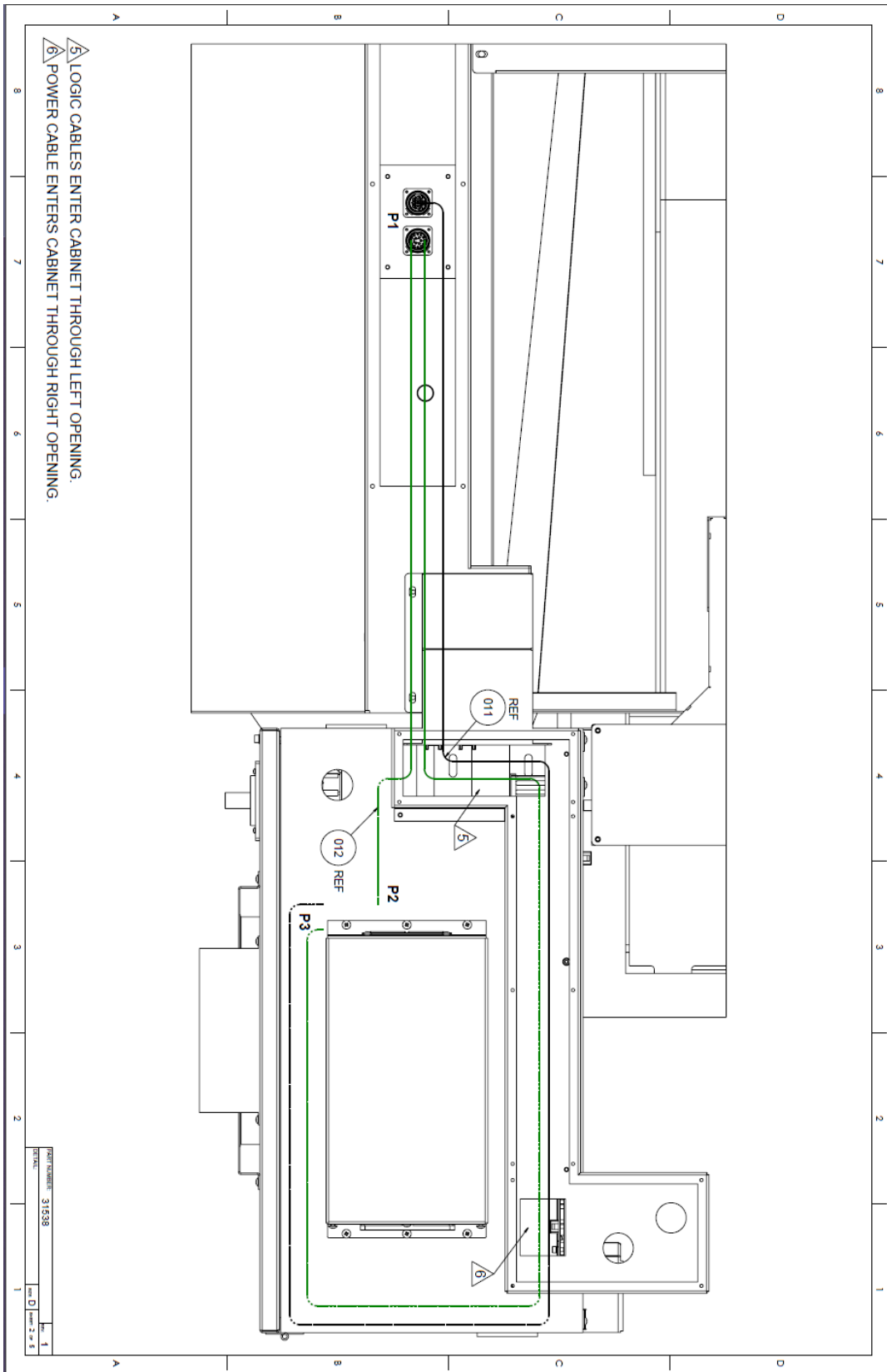

133

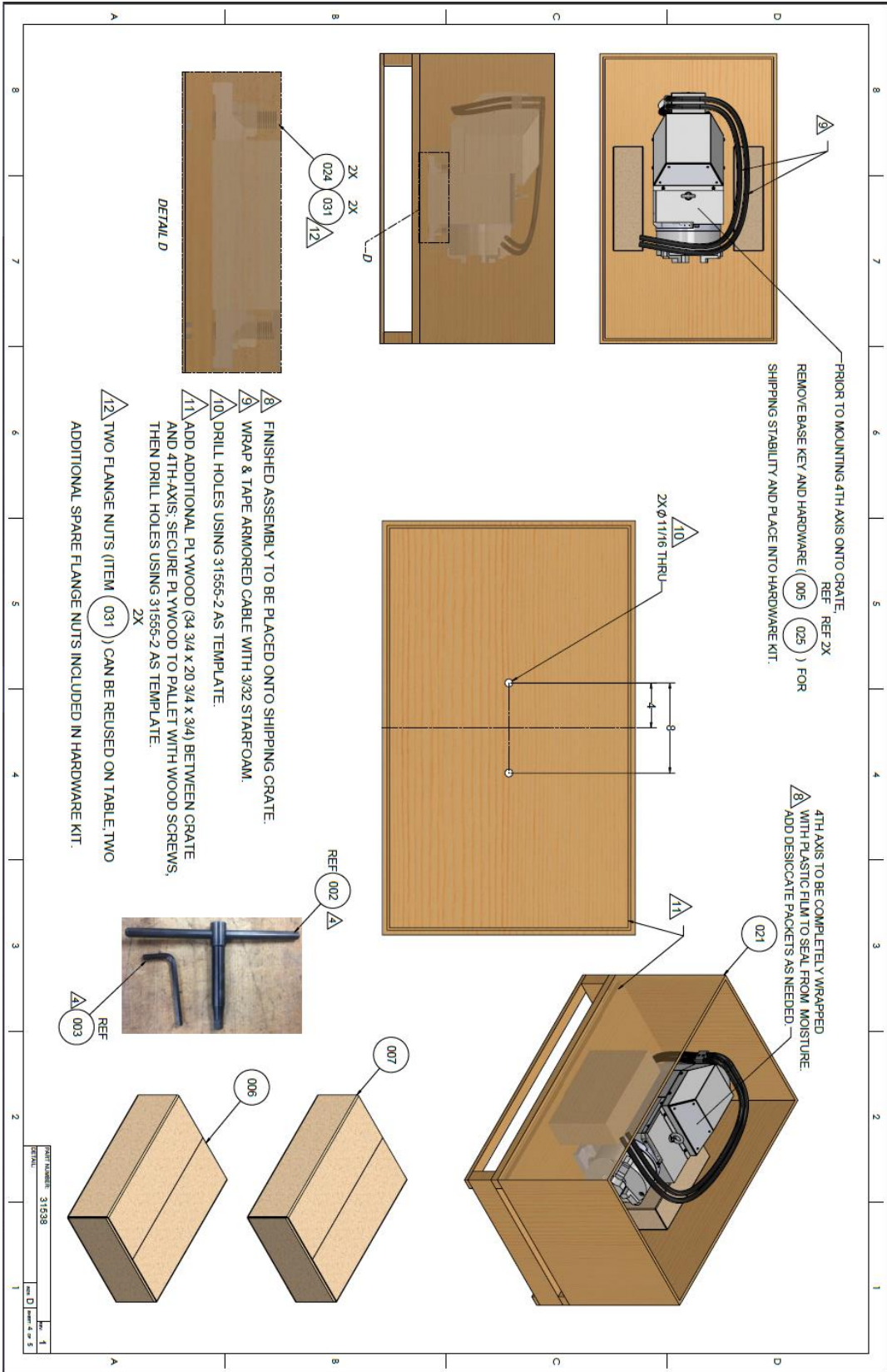

Item No.	Part Number	Description	Detail	Type	QTY.	Item Length	Category	MFG Part Number	Manufacturer
001	31530	4TH AXIS-ASSY-TMC		Normal	1		Manufactured		
002	27115	T-HANDLE		Reference	1		Purchased	A-133-041	King Rich
003	27643-1	WRENCH-ALLEN-6MM	SEE 27066-6	Reference	1		Purchased		
004	27053-1	CLAMPING BLOCK-4TH AXIS-SWI		Normal	2		Manufactured		
005	28058	KEY-BASE-4TH AXIS-SWI		Reference	1		Manufactured		
006	27124-5	HARDWARE KIT-4TH AXIS-TMC		Normal	1		Manufactured		
007	27124-6	ELECTRONICS KIT-4TH AXIS-TMC		Normal	1		Manufactured		
008	29980-4TH	SERVO DRIVE-DELTA PROGRAMMED-RX		Reference	1		Manufactured		
009	31537	MOUNTING BRACKET-CABLE HARNESS-4TH AXIS		Reference	1		Purchased		
010	22443-8	CABLE ASSY-DELTA DRIVE TO RX COMPUTER		Reference	1		Manufactured		
011	26840-32	CABLE ASSY-POWER EXTENSION-4TH AXIS		Reference	1		Manufactured		
012	26844-35	CABLE ASSY-LOGIC EXTENSION-4TH AXIS		Reference	1		Manufactured		
013	31557-1	WIRE ASSY-4TH AXIS-TMC	L1-6	Reference	1		Manufactured		
014	31557-2	WIRE ASSY-4TH AXIS-TMC	L2-6	Reference	1		Manufactured		
015	31557-3	WIRE ASSY-4TH AXIS-TMC	L1-7	Reference	1		Manufactured		
016	31557-4	WIRE ASSY-4TH AXIS-TMC	L2-7	Reference	1		Manufactured		
017	31557-5	WIRE ASSY-4TH AXIS-TMC	L3-7	Reference	1		Manufactured		
018	31557-6	WIRE ASSY-4TH AXIS-TMC	GND	Reference	1		Manufactured		
019	29117	JUMPER ASSY-AXIS LOOP BACK		Reference	1		Manufactured		
020	26812-3	BAG-ANTI STATIC-3XS"		Normal	1		Purchased	756ST6035	TECHN1-TOOL
021	31555	CRATE-SHIPPIG-4TH AXIS-TMC		Normal	1		Purchased	S-13372	Uline
022	31539-LB1	LABEL-4TH AXIS-TMC-REMOVED		Normal	1		Manufactured		
023	23792	T BOLT-5/8-11 X 2.5		Reference	2		Purchased		
024	58-11X3-1/2 (2Z)	BOLT-CARRIAGE-STEEL-ZINC		Normal	2		Purchased		
025	10-32X1/2 (25B)	SCREW-SHCS-STL-BO	STOCKED	Reference	2		Purchased		
026	M5-0.8X12 (25B)	SCREW-SHCS-STL-BO	STOCKED	Reference	7		Purchased		
027	4-40X5/16 31Z	SCREW-PH-PHIL-EXT SEMS-STL-ZINC		Reference	8		Purchased		
028	23794	WASHER-5/8 OD X 1.375 X ID 6/66 X .17-.20 THK		Reference	2		Purchased		
029	24009-4	WASHER-BELLEVILLE SPRING LK-SERRATED	209 ID X .354 OD X .0212 THK-10 OR MS	Reference	7		Purchased		
030	M6 (70B)	WASHER-FLAT USS-STL-BO	STOCKED	Reference	7		Purchased		
031	23793	FLANGE NUT 5/8-11		Normal	2		Purchased		
032	31539-DOC	4TH AXIS OPTION-TMC		Normal	1		Purchased		

PRODUCTS USED ON:

REV: 1 SHEET: 5 OF 5

TRAK Machine Tools
Southwestern Industries, Inc

TRAK Warranty Policy

Warranty

TRAK products are warranted to the original purchaser to be free from defects in workmanship and materials for the following periods:

Product	Warranty Period	
	Materials	Factory Labor
New TRAK/ProtoTRAK	1 Year	1 Year
Any EXCHANGE Unit	90 Days	90 Days

The warranty period starts on the date of the invoice to the original purchaser from Southwestern Industries, Inc. (SWI) or their authorized distributor.

If a product, subsystem or component proves to be defective in workmanship and fails within the warranty period, it will be repaired or exchanged at our option for a properly functioning unit in similar or better condition. Such repairs or exchanges will be made FOB Factory/Los Angeles or the location of our nearest factory representative or authorized distributor.

Warranty Disclaimers

- This warranty is expressly in lieu of any other warranties, express or implied, including any implied warranty of merchantability or fitness for a particular purpose, and of any other obligations or liability on the part of SWI (or any producing entity, if different).
- Warranty repairs/exchanges do not cover incidental costs such as installation, labor, freight, etc.
- SWI is not responsible for consequential damages from use or misuse of any of its products.
- TRAK products are precision mechanical/electromechanical/electronic systems and must be given the reasonable care that these types of products require. Evidence that the product does not receive adequate Preventative Maintenance may invalidate the warranty. Excessive chips built up around ballscrews and way surfaces is an example of this evidence.
- Accidental damage, beyond the control of SWI, is not covered by the warranty. Thus, the warranty does not apply if a product has been abused, dropped, hit or disassembled.
- Improper installation by or at the direction of the customer in such a way that the product consequently fails, is considered to be beyond the control of the manufacturer and outside the scope of the warranty.
- Warranty does not cover wear items that are consumed under normal use of the product. These items include, but are not limited to: windows, bellows, wipers, filters, drawbars and belts.

F10302 | Rev: 020620