

TRAK® VMCsi

Siemens Sinumerik® CNC

Safety, Installation, Maintenance, Service and Parts List

Document:	P/N 34104
Version:	122123

Covers Current Models:

- TRAK VMC7si
- TRAK VMC10si
- TRAK VMC12si
- TRAK VMC14si

TRAK MACHINE TOOLS



SOUTHWESTERN INDUSTRIES, INC.

2615 Homestead Place
Rancho Dominguez, CA 90220-5610 USA
T | 310.608.4422 | F | 310.764.2668
Service Department: 800.367.3165
e-mail: sales@trakmt.com | service@trakmt.com | web: www.trakmt.com

Copyright © 2021, Southwestern Industries, Inc. All rights are reserved. No part of this publication may be reproduced, stored in a retrieval system, or transmitted, in any form or by any means, mechanical, photocopying, recording or otherwise, without the prior written permission of Southwestern Industries, Inc.

While every effort has been made to include all the information required for the purposes of this guide, Southwestern Industries, Inc. assumes no responsibility for inaccuracies or omission and accepts no liability for damages resulting from the use of the information contained in this guide.

All brand names and products are trademarks or registered trademarks of their respective holders.

TRAK Machine Tools

Southwestern Industries, Inc.
2615 Homestead Place
Rancho Dominguez, CA 90220-5610
Phone 310.608.4422 ▪ Fax 310.764.2668
Service Department
Phone 800.367.3165 ▪ Fax 310.886.8029
Web: www.trakmt.com

Table of Contents

1.0	Safety and Operations	5
1.1	Safety Publications	6
1.2	Danger, Warning, Caution, Note Labels & Notices as Used in This Manual	6
1.3	Sinumerik User Operation Modes	10
1.3.1	Sinumerik Password and Key Switch Access Levels	11
1.3.2	Real Machine Security Recommendation	11
1.3.3	General Access Information:	12
1.3.4	VMCsi Password Management	12
1.3.5	Introduction to the Sinumerik Touchscreen & Machine Control Panel	14
1.4	Safety Precautions	17
2.0	Installation of TRAK VMCsi Series Machining Centers	19
2.1	Installation Requirements	19
2.2	Cleaning the VMCsi	19
2.3	Lifting and/or Placing the VMCsi	19
2.4	Overall Dimensions	20
2.5	Uncrating the VMCsi	25
2.5.1	Releasing the Head Support Bracket	26
2.6	Leveling Procedure	26
2.6.1	Leveling Pad Specifications	27
2.6.2	Leveling and Tram Procedure VMC7si and VMC10si	27
2.6.3	Leveling And Tram Procedure VMC12si and VMC14si	30
2.7	Shortages: Inventory Checklist	32
2.8	Electrical Connection	33
2.8.2	Main Power to the Machine Connections	34
2.8.3	Transformer Option Requirements	35
2.9	Air Connection	36
2.9.1	Air Regulators and Solenoids	36
2.10	Placing the Coolant System	38
2.11	Placing the Coolant Through Spindle (CTS) System	42
2.12	Placing the Chip Conveyor System	45
2.13	Optional Skimmer System	46
2.14	Installation Checklist	46
2.15	Tool Setter, Workpiece Probes and Required Optical Receiver	51

2.15.1	Mount OMI-2T Optical Receiver	51
2.15.2	Setup and Calibration of The Optical Tool Setting Probe Option	60
2.15.3	Setup and Calibration of The Optical Workpiece Probe Option.....	74
2.16	Lubrication.....	86
2.16.1	Way Lubrication	86
2.16.2	Other VMCsi Lubrication Points	87
2.17	VMCsi Machine Specifications	87
2.18	Siemens Euclid Block Procedure	91
3.0	Troubleshooting.....	93
3.1	Flashing or Dark Machine Control Panel (MCP)	93
3.2	Handwheels Do Not Work	93
3.3	No Signal from the Probe.....	94
3.4	Check Defective Drive System Using System Topology.....	95
3.5	Check Alarm Log for Errors	96
3.6	ATC Magazine Rotates the Wrong Direction	97
3.7	ATC Magazine Out of Sync with Control Display	98
3.8	Pendant Screen Print.....	99
4.0	Automatic Tool Changer	99
4.1	Service Intervals	99
4.2	Maintenance Steps	100
4.2.1	Arm Spring and Plunger Mechanism.....	100
4.2.2	Cam Box	102
4.2.3	Cam Box Oil Change	103
4.2.4	Carousel.....	103
4.2.5	Pots.....	104
4.3	ATC or Swivel Head Service Mode	104
4.3.1	Benefits of Service Mode	104
4.3.2	Considerations Before Using.....	104
4.3.3	MCP Buttons Used	105
4.3.4	How to Use	105
4.3.5	Example of Service Mode in Use	107
4.4	Set Tool Change Height.....	110
4.5	Tool Management Alarm Codes.....	110
4.6	Specialty Tools.....	112
4.6.1	ATC Tool Remover.....	112

5.0	Maintenance and Replacement	114
5.1	Maintenance	114
5.1.1	How to Clean the Touchscreen & Pendant.....	114
5.1.2	Periodic Maintenance	114
5.1.3	Tool Change Pots – Cleaning & Visual	114
5.1.4	Tool Clamp/Unclamp – Checking Adjustment.....	115
5.2	Diagnostic I/O Screens	115
5.2.1	4 th Axis & Automatic Tool Changer I/O.....	116
5.2.2	Auxiliary Inputs/Outputs	116
5.2.3	Hand Held Unit (HHU) or EHW	117
5.2.4	Lubrication, E-Stop, Sinamics Controls	117
5.2.5	Testing and Spare Inputs	118
5.2.6	Automation Ready Inputs/Outputs.....	118
5.2.7	Alarm and Message Lists	119
6.0	4th Axis Option	119
6.1	Start and Stop 4 th Axis Operation	120
6.2	4 th Axis Specifications	121
6.3	Mounting the 4 th Axis.....	122
6.4	Installation Checklist of the 4 th Axis	125
6.5	Troubleshooting by Symptom.....	130
6.6	4 th Axis Chuck and Adapter Plate Removal and Replacement.....	130
7.0	Introduction to Self-Service	132
7.1	When You Have a Service Problem.....	132
7.1.1	Communication with the SWI Customer Service Group.....	132
7.2	Replacements	132
7.2.1	Exchange Program.....	132
7.2.2	Return Material Authorization (RMA) Number	133
	TRAK Warranty Policy.....	134

1.0 Safety and Operations

The safe operation of the TRAK VMCsi depends on its proper use and the precautions taken by each operator.

- Read and study this manual and the Siemens SINUMERIK ONE CNC VMCsi Safety and Operating Manual TRAK Part Number 34105. Be certain every operator understands the operation and safety requirements of this machine before its use.
- Never run the machine with enclosure doors open.
- Always wear safety glasses and safety shoes.
- Always stop the spindle and check to ensure the CNC control is in the stop mode before changing or adjusting the tool or workpiece.
- Never wear gloves, rings, watches, long sleeves, neckties, jewelry, or other loose items when operating or around the machine.
- Use adequate point of operation safeguarding. It is the responsibility of the employer to provide and ensure point of operation safeguarding per OSHA 1910.212 - Milling Machine.

1.1 Safety Publications

Refer to and study the following publications for assistance in enhancing the safe use of this machine.

Safety Requirements for Machining Centers and Automatic, Numerically Controlled Milling, Drilling and Boring Machines (ANSI B11.23-2002) (R2007). Available from The American National Standards Institute, 1819 L Street N.W., Washington D.C. 20036

Concepts and Techniques of Machine Safeguarding (OSHA Publication Number 3067). Available from The Publication Office - O.S.H.A., U.S. Department of Labor, 200 Constitution Avenue, NW, Washington, DC 0210.

1.2 Danger, Warning, Caution, Note Labels & Notices as Used in This Manual

DANGER - Immediate hazards that **will** result in severe personal injury or death. Danger labels on the machine are red in color.

WARNING - Hazards or unsafe practices which *could* result in severe personal injury and/or damage to the equipment. Warning labels on the machine are orange in color.

CAUTION - Hazards or unsafe practices, which *could* result in minor personal injury or equipment/product damage. Caution labels on the machine are yellow in color.

NOTE - Call attention to specific issues requiring special attention or understanding.

Safety & Information Labels Used on The TRAK Milling Machines
It is forbidden by OSHA regulations and by law to deface, destroy or remove any of these labels

208 VOLTS

480 VOLTS

TRAK MACHINE TOOLS

SOUTHWESTERN INDUSTRIES, INC.

Service: 800-367-3165

Office: 800-421-6875

www.TRAKMT.com



@PrakTRAK

@PrakTRAK

CAUTION

1. Air pressure must be between 6 - 7kgf/cm² (85psi-100psi).
2. Filter and Lubricator must be maintained once a week.
3. Recommended Air line - 12mm (1/2 inch).

S-S2050



ISO VG 32
Slideway Oil
ONLY

8-81121



Safety & Information Labels Used on The TRAK Milling Machines



Air pressure setting	
Max.pressure setting	115psi / 8kg/cm ²
Min.pressure setting	70psi / 5kg/cm ²
Pressure sensor setting	60psi / 4 kg/cm ²

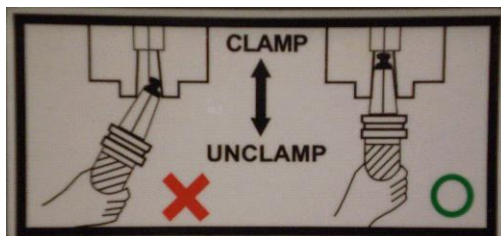

SAFETY INSTRUCTIONS

1. Read and understand Operator's Manual and all warnings on the sign before operating. Failure to follow these instructions and warnings can result in serious injury or death.
2. This machine starts and moves automatically. Never place any part of your body near or on moving parts of this machine.
3. Always stop the spindle completely before touching the work piece, tool or spindle.
4. Do not operate this machine unless all guards, interlocks and other safety devices are in place and functioning.
5. Always clamp work piece and cutting tool securely. avoid excessive feeds and spindle speeds.
6. Remove rings, watches, jewelry and loose fitting clothing. Keep your hair away from moving parts of the machine.
7. Always wear safety glasses, safety shoes and hearing protection when operating this machine.
8. Service or installation of this machine must be performed by qualified personnel only, following procedures described in the Maintenance Manual. Turn off and lock out power at main electrical panel before servicing.

It is the responsibility of the user to be sure that this machine is in safe operating condition at all times and that the operator follows the safe operating procedures described in the Operator and Maintenance Manuals and all signs attached to this machine. If you have any questions concerning the safe operation of this machine, contact your supervisor or local Distributor.

Please do not remove or disfigure this sign.

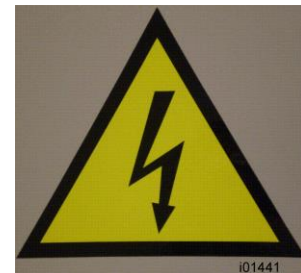

Safety & Information Labels Used on The TRAK Milling Machines

MAINTENANCE SCHEDULE

DAILY

- Remove majority of chips from around the axis slide ways, work table, and ballscrew covers.
- Drain the water from the air regulator assembly by either turning off the air to the machine or depressing the valve at the bottom of the water collector tank.
- Check to make sure there are no obvious oil leaks to the lubrication system.
- Visually check coolant level and add if low.

WEEKLY

- Visually check lubrication pump oil level and make sure it is always above the minimum line. Fill with ISO VG32/SAE10W.
- Check the oil level in the pneumatic system lubricator and add if low.
- Remove and clean air filters on the door and the top of the electrical cabinet and replace if needed.

MONTHLY OR AS SPECIFIED

- Visually check the air regulator filter and replace if needed.
- Check the oil level of the Tool Change Air Cylinder Oil Cup, and add if low.
- Perform all maintenance on the ATC as listed in the Machine Service Manual.
- Every 3 months remove and drain the coolant tank, clean all debris and fill with new coolant.
- Every 6 months check the level and tram of the machine and adjust as necessary.
- Every 6 months check the spindle motor belt tension and adjust as necessary.

YEARLY

- Check backlash on each axis and adjust as necessary. Refer to the machine manual for service codes.
- Remove all covers, vacuum chips and debris that may have built up, and wipe down machine from top to bottom.
- Inspect the tool change air cylinder.
- Inspect machine for any unusual wear and play.
- Check cables, coolant hoses and pneumatic lines for any excess abrasion or cuts.

Please contact SWI Service Dept. for help with any machine maintenance procedures.

Service Dept. contact number is 1-800-367-3165.

Safety & Information Labels Used on The TRAK Milling Machines



TRAK Serial Number Plate will have the specific information engraved applicable to the mill.

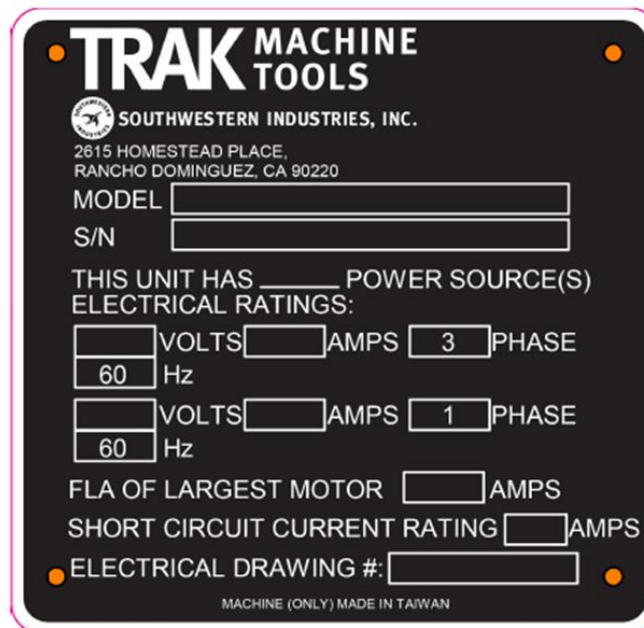

1.3 Sinumerik User Operation Modes

1.3.1 Sinumerik Password and Key Switch Access Levels

The Sinumerik control allows many different access levels which can be used based upon our customer's needs and applications. The service level will be used to set up and configure your mill. Customers may have a need for this level. Manufacturer level access will be used by TRAK staff as needed.

Three different color keys (Black, Green, & Orange) are provided with the VMCsi mill. There are four positions (0, 1, 2, & 3) of the keys when used in the mill located every 90° around the lock mounted on the MCP. figure 1.3.1a for a photo of the keys, and switch positions on the MCP. The assignment of which access level and which switch position will be assigned by management by the customer for each needed user level see figure 1.3.1b for an explanation of the levels involved.



Figure 1.3.1a – VMCsi Keys & Switch Positions

Key Color	Switch Position	Access Level
No Key Required	0	7
Black	0 & 1	6-7
Green	0, 1 & 2	5-7
Orange	0, 1, 2, & 3	4-7

Access Level	Intended User	Protection Via	Access to:
1	Manufacturer	Password	Defined functions, programs and data; e.g. entering options
2	Installation Engineer	Password	Defined functions, programs and data; e.g. most machine data
3	End User	Password	Assigned function, programs and data
4	Programmer, Setter	Key Switch Position 3	Less than protection levels 0-3. Defined by the manufacturer/end user.
5	Qualified Operator	Key Switch Position 2	Less than protection levels 0-3. Defined by the end user.
6	Trained Operator	Key Switch Position 1	Ex: Program selection only. Tool wear and offset entry
7	Untrained Operator	Key Switch Position 0	Ex: No tool wear & offset entries or program selection possible

Figure 1.3.1b – User Access

1.3.2 Real Machine Security Recommendation

The above passwords are default. For IT security reasons it is recommended that individual passwords are assigned to protect unauthorized machine modifications.

1.3.3 General Access Information:

- Protection level 1 provides the highest access rights, protection level 7 the least.
- Higher protection level gets lower access rights e.g. key switch 0 position is higher protection level than key switch 1 and key switch 0 gets access to fewer features of the mill than key switch 1. Access rights increase as you decrement the access level numbering see figure 1.3.1b.
- Conversely, protection rights for a certain protection level can only be altered from a higher protection level. Protection level and access level are two different things. Key switch 0 is higher protection level and key switch 1 is lower protection. You can access more features with key switch 1 than with key switch 0, e.g., key switch 1 is higher access level and lower protection level than key switch 0.
- Access rights for password levels 1 to 3 are assigned by Siemens and cannot be altered.
- Access rights can be set by querying the current key switch positions and comparing the passwords entered. When a password is entered it overwrites the access rights of the key-switch position.
- Options can be protected on each protection level. However, option data can only be entered in protection level 1. Access rights for protection levels 4 to 7 are only suggestions and can be altered by the machine tool manufacturer or end user.

1.3.4 VMCsi Password Management

There are three password levels and four key switch positions defined in the mill. Change password will change one of the three passwords in the machine. Set password sets your access level to one of those levels for your current session on the machine. When you Delete a password, you are removing that access level and switching to the access level based on the switch position. See section 2.18 for more information. At right, the image shows just above the Horizontal Soft Keys (HSK) the display shows the current access level.

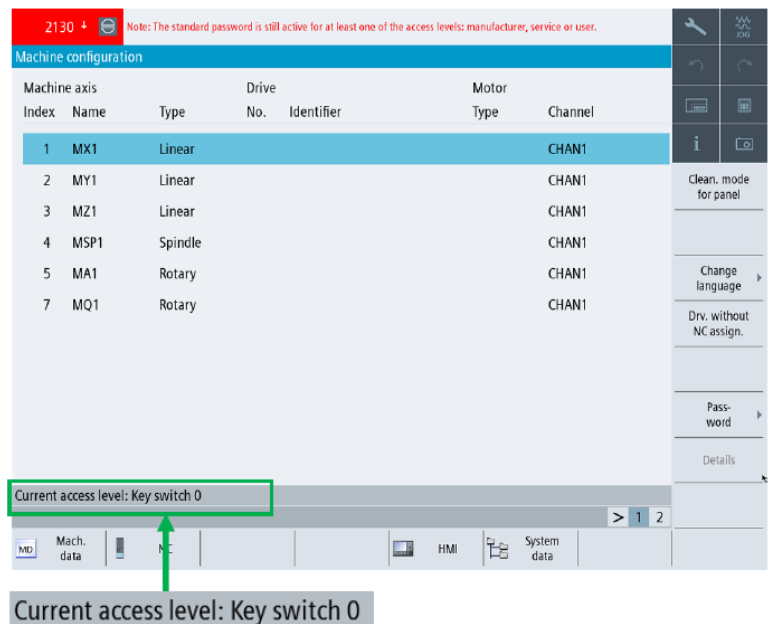

Access Password Options

In order to change the current password, use the Vertical Soft Keys (VSK) on the left side of the screen and press "[M]", then the "Setup" or wrench icon still on the left VSK. If the Horizontal Soft Keys are at the top level (i.e. There is no "^" in the HSK left most button. If there is a "^", press that button until clear.), press "Password" along the right VSK.

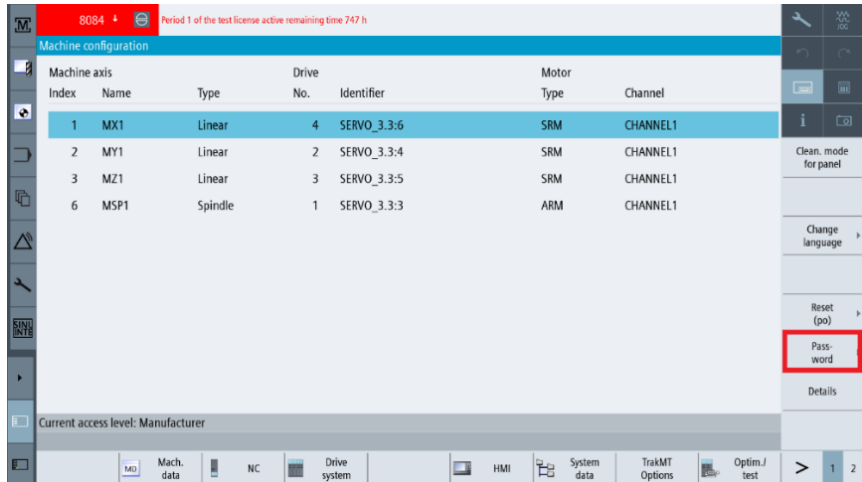

Password Options

You will then see three password options as shown. If you want to set a password, press "Set password" and go to the Set Password step for you to login to a specific level. The "Change password" changes the password for a specific level. Go to the "Change password" step if needed. "Delete password" changes access level to the setting of the key switch, go to that step for details

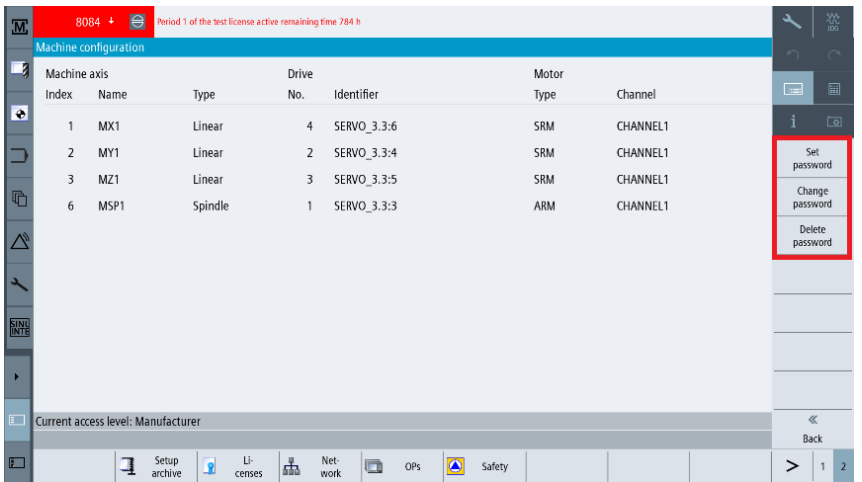

Set Password

Click on "Set Password" which is used to change from one access level to another. "Please enter password" input line and use the keyboard to enter your password. Press either "Ok" or "Cancel" to complete the operation.

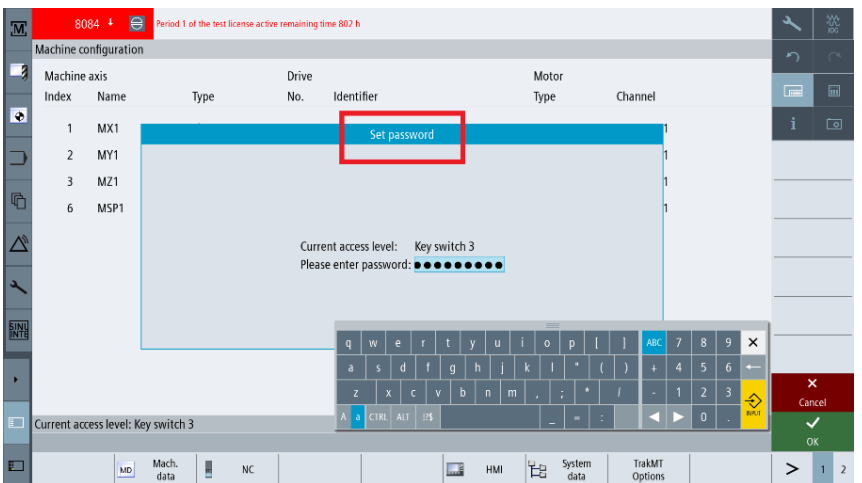

Change Password

Click on "Change Password" and then enter your password at the prompt. This will confirm you have access to change the current login. Press either "Ok" or "Cancel" to complete the operation.

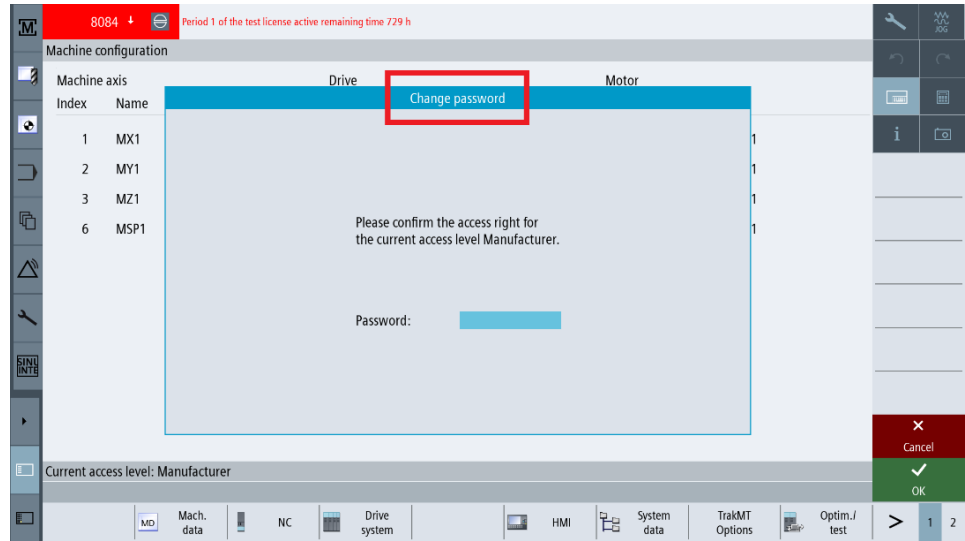

Delete Password

Press "Delete Password" and you will be asked to confirm you want to delete and set to the access level based upon the key switch. Press either "Ok" to delete the password, "Cancel" will abort the operation.

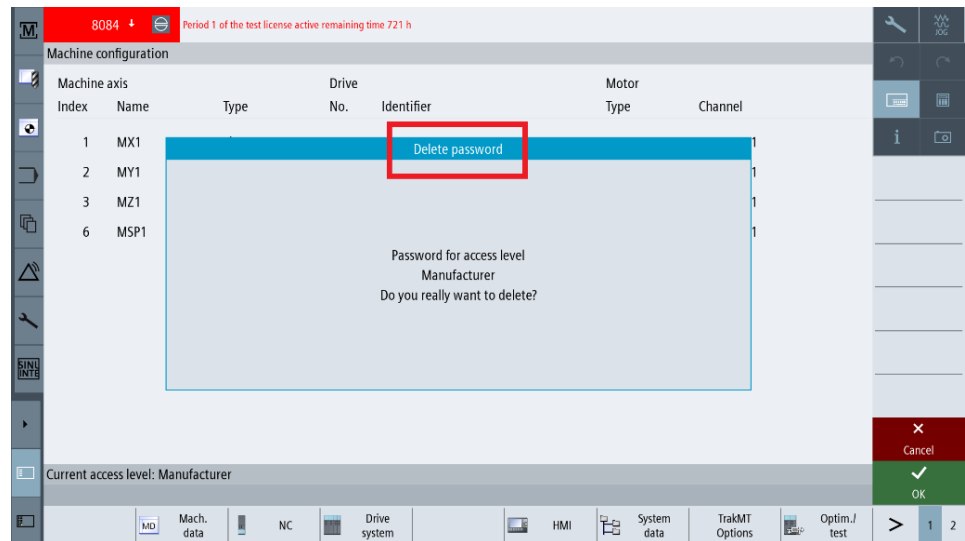

1.3.5 Introduction to the Sinumerik Touchscreen & Machine Control Panel

1.3.5.1 Touchscreen

Here is the main Sinumerik human interface screen. The image below in figure 1.3.5.1 shows the items available on the screen to the operator with their functions.

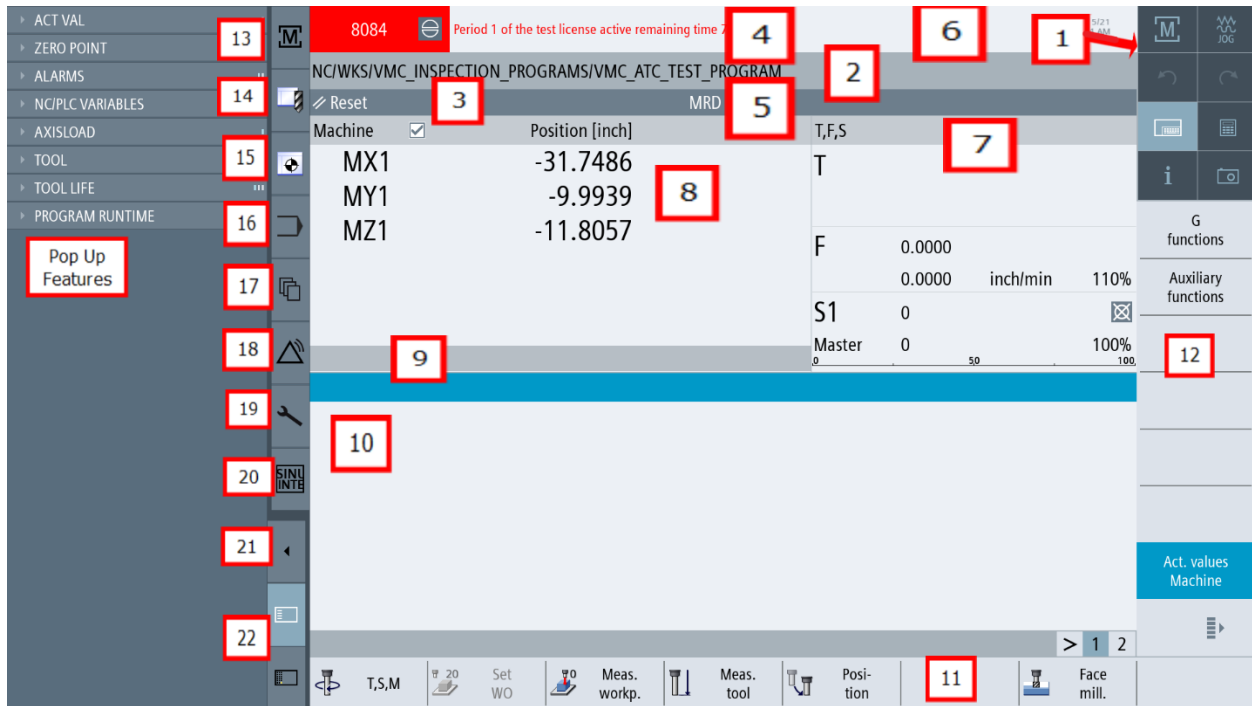

Definitions:

- | | |
|---|--|
| 1. Active operating area and work mode (8 boxes) | 11. Horizontal soft key (HSK) bar |
| 2. Program path and name | 12. Vertical soft key (VSK) bar |
| 3. Status, program influence and channel name | 13. Machine |
| 4. Alarm and message line | 14. Tool list |
| 5. Channel operation messages | 15. Work offsets |
| 6. Date and time | 16. Program |
| 7. Display of: T=Active tool, F=Present federate
S=Spindle, Spindle load factor in percent | 17. Program manager |
| 8. Position readout for the axes | 18. Diagnostics |
| 9. Display of the active zero point, rotation,
Mirroring and scaling | 19. Setup |
| 10. Working window | 20. Sinumerik Integrate |
| | 21. Toggle to access pop up real time features; |
| | 22. Listed: actual value, zero point, alarms, NCIPLC
variables, axis load, tool, tool life, program runtime |

Figure 1.3.5.1 Touchscreen and Functions

1.3.5.2 Machine Control Panel (MCP)

Here is the layout of the keyboard including E-Stop, Key Switch, Spindle Speed Override, Feed Rate Override, and Electronic Hand Wheel. EHW is operated by holding both buttons on either side of the hand wheel, using the small left knob to select axis, small right knob determines speed while the big knob controls movement. See Figure 1.3.5.2.



Figure 1.3.5.2 - VMCsi Password and Key Switch Access Levels

1.4 Safety Precautions

1. Do not operate this machine before the TRAK VMCsi Installation, Maintenance, Service and Parts List Manual, and TRAK VMCsi Operating & Care Manual have been studied and understood.
2. Do not run this machine without knowing the function of every control key, button, knob, or handle. Ask your supervisor or a qualified instructor for help when needed.
3. Protect your eyes. Wear approved safety glasses (with side shields) at all times.
4. Don't get caught in moving parts. Before operating this machine remove all jewelry including watches and rings, neckties, and any loose-fitting clothing.
5. Keep your hair away from moving parts. Wear adequate safety headgear.
6. Protect your feet. Wear safety shoes with oil-resistant, anti-skid soles, and steel toes.
7. Take off gloves before you start the machine. Gloves are easily caught in moving parts.
8. Remove all tools (wrenches, chuck keys, etc.) from the machine before you start. Loose items can become dangerous flying projectiles.
9. Never operate a milling machine after consuming alcoholic beverages, or taking strong medication, or while using non-prescription drugs.
10. Protect your hands. Stop the machine spindle and ensure that the CNC control is in the stop mode:
 - Before changing tools
 - Before changing parts
 - Before you clear away the chips, oil or coolant. Always use a chip scraper or brush
 - Before you make an adjustment to the part, fixture, coolant nozzle or take measurements
 - Before you open safeguards (protective shields, etc.). Never reach for the part, tool, or fixture around a safeguard.
11. Protect your eyes and the machine as well. Don't use compressed air to remove the chips or clean the machine.
12. Disconnect power to the machine before you change belts, pulley, and gears.
13. Keep work areas well lighted. Ask for additional light if needed.
14. Do not lean on the machine while it is running.
15. Prevent slippage. Keep the work area dry and clean. Remove the chips, oil, coolant and obstacles of any kind around the machine.
16. Avoid getting pinched in places where the table, saddle, tool changer or spindle head create "pinch points" while in motion.
17. Securely clamp and properly locate the workpiece in the vise, on the table, or in the fixture. Use stop blocks to prevent objects from flying loose. Use proper holding clamping attachments and position them clear of the tool path.
18. Use correct cutting parameters (speed, feed, depth, and width of cut) in order to prevent tool breakage.
19. Use proper cutting tools for the job. Pay attention to the rotation of the spindle: Left hand tool for counterclockwise rotation of spindle, and right-hand tool for clockwise rotation of spindle.

20. After an emergency stop, release the E-stop and press the reset button.
21. Prevent damage to the workpiece or the cutting tool. Never start the machine (including the rotation of the spindle) if the tool is in contact with the part.
22. Check the direction (+ or -) of movement of the table, saddle, and quill when using jog or Manual Pulse Generator (MPG).
23. Don't use dull or damaged cutting tools. They break easily and become airborne. Inspect the sharpness of the edges, and the integrity of cutting tools and their holders. Use proper length tool for the job.
24. Large overhang on cutting tools when not required result in accidents and damaged parts.
25. Inspect the retention knobs for damage or excessive wear before each use.
26. Prevent fires. When machining certain materials (magnesium, etc.) the chips and dust are highly flammable. Obtain special instruction from you supervisor before machining these materials. Keep flammable materials and fluids away from the machine and hot, flying chips.
27. Always be certain that you know the operation level of the machine before use. Use your password access to verify the correct operation level (See Section 1.3).
28. Always be certain the door is closed during operation.

2.0 Installation of TRAK VMCsi Series Machining Centers

IMPORTANT: Read and understand this entire installation section before beginning the VMCsi installation.

2.1 Installation Requirements

Before an Authorized Field Service Technician can perform the machine's final checkout, detailed requirements must be met. Please refer to the Site Preparation Guide for the needed set up for your specific VMCsi model.

2.2 Cleaning the VMCsi

1. Remove all the cardboard and protective plastic sheeting from the machine.
2. With a soft cloth, remove all the protective oil from the machine. **DO NOT USE ANY SHARP OBJECTS ON THE LINEAR GUIDEWAYS OR THE BALL SCREW. USE ONLY LINT FREE CLOTH IN THESE AREAS.** It may be necessary to move the table, saddle and head left and right, up and down when cleaning.
3. Clean the way covers as they come shipped with a rust prevention spray on them. WD-40 works well to remove this agent.
4. When cleaning the windows, use a suitable cleaner that **DOES NOT** contain ammonia or solvents that could damage the polycarbonate windows.

WARNING!

Do not use water-based cleaning agents for cleaning the machine.

ATTENTION!

Immediately report, in writing, any damages observed at this time that can be attributed to the transportation or improper handling/moving of the machine.

2.3 Lifting and/or Placing the VMCsi

The machine must be in position and placed on its rest pads. Please make sure to use a large enough forklift when lifting the VMCsi machine. When removing the machine from the pallet, please note that the center of gravity (CG) varies based on the VMCsi model. Please refer to the Site Preparation Guide for the needed set up for your specific VMCsi model. See figures 2.4a and 2.4b.

The VMCsi must be lifted from either the left or right hand sides. Make certain that the forks are squarely in the lifting cutouts beneath the machine. See the figures below.



Figure 2.4a - Fork Lift with VMC14si Cargo



Figure 2.4b - Detail of Fork lift blades set in VMCsi base and proper set up of Leveling Pads

2.4 Overall Dimensions

VMC7si

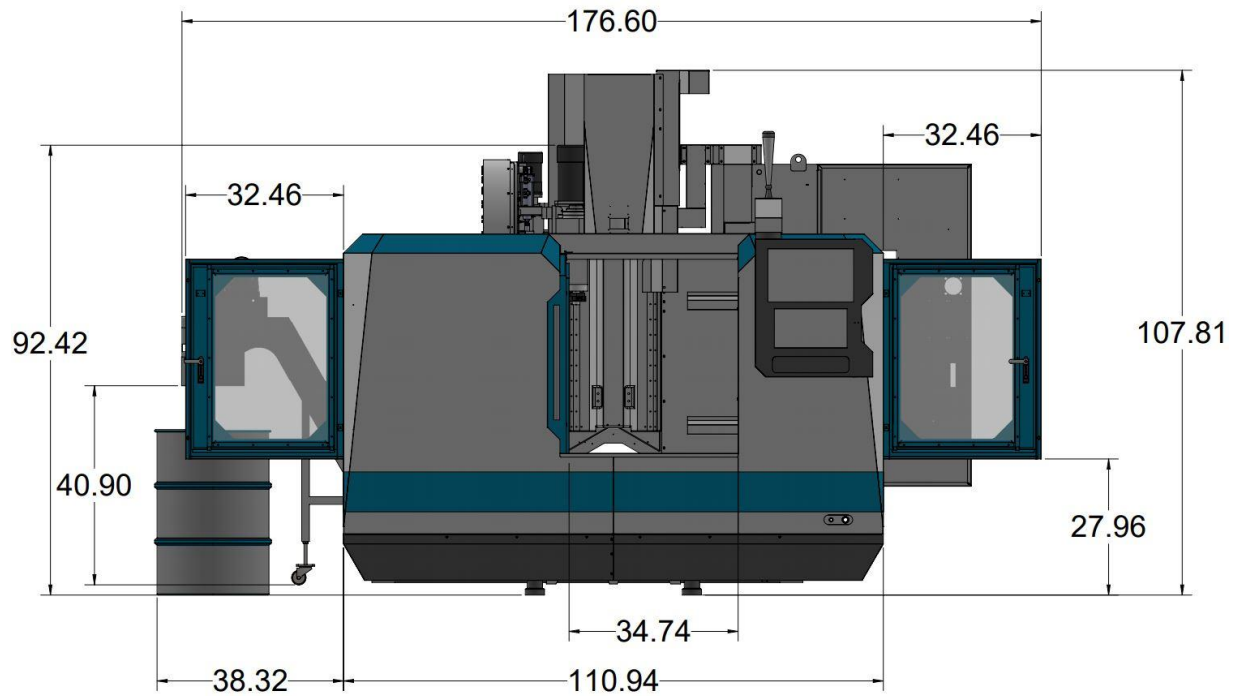

VMC7si Front View

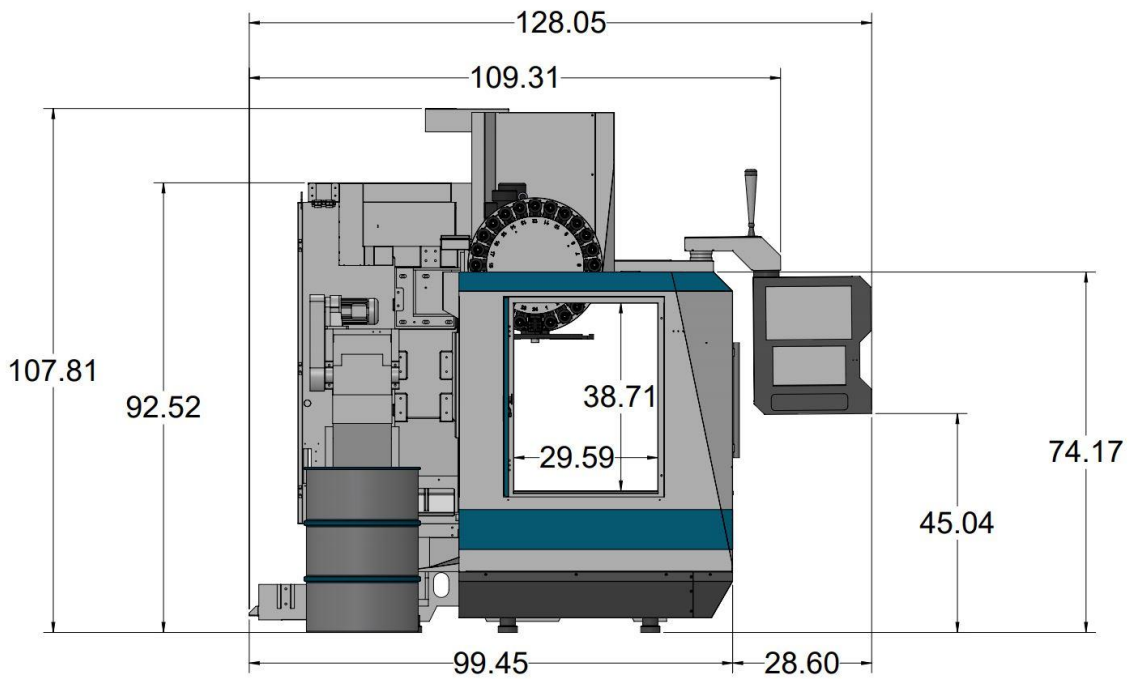

VMC7si Left Side View

VMC10si

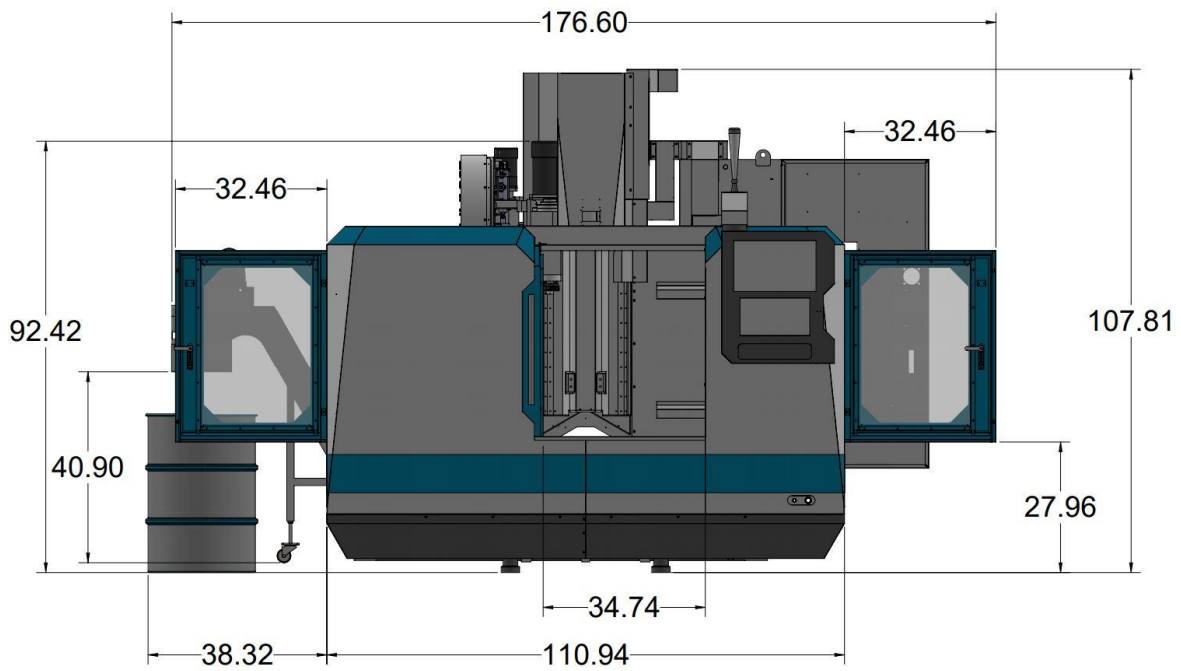

VMC10si Front View

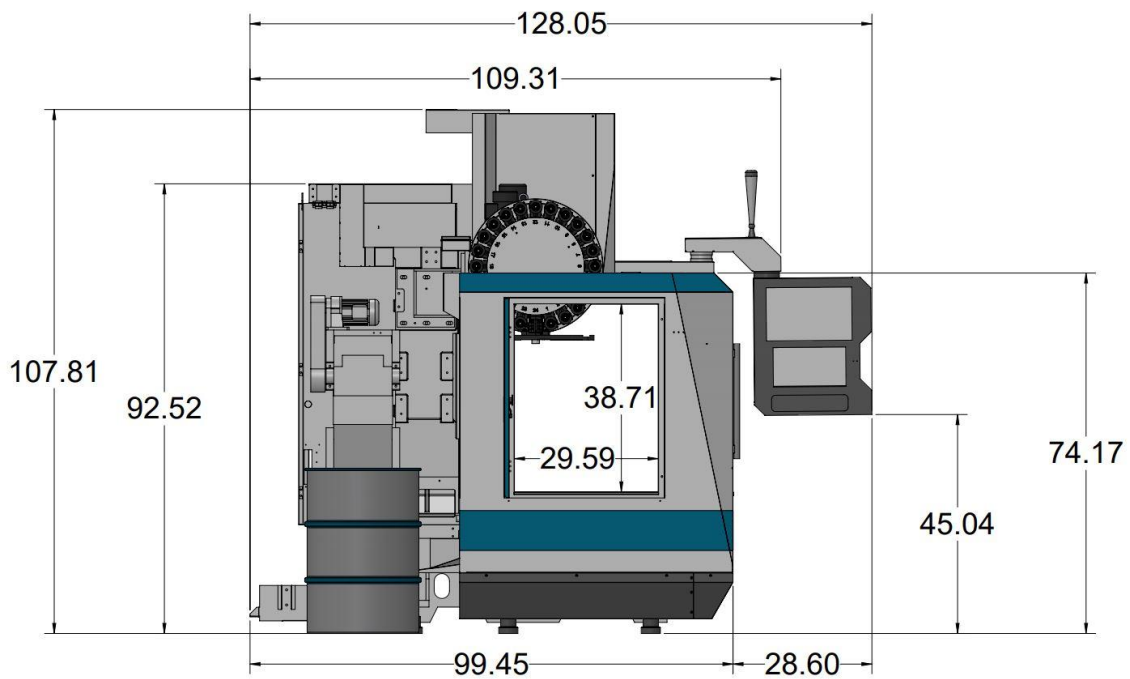

VMC10si Left Side View

VMC12si

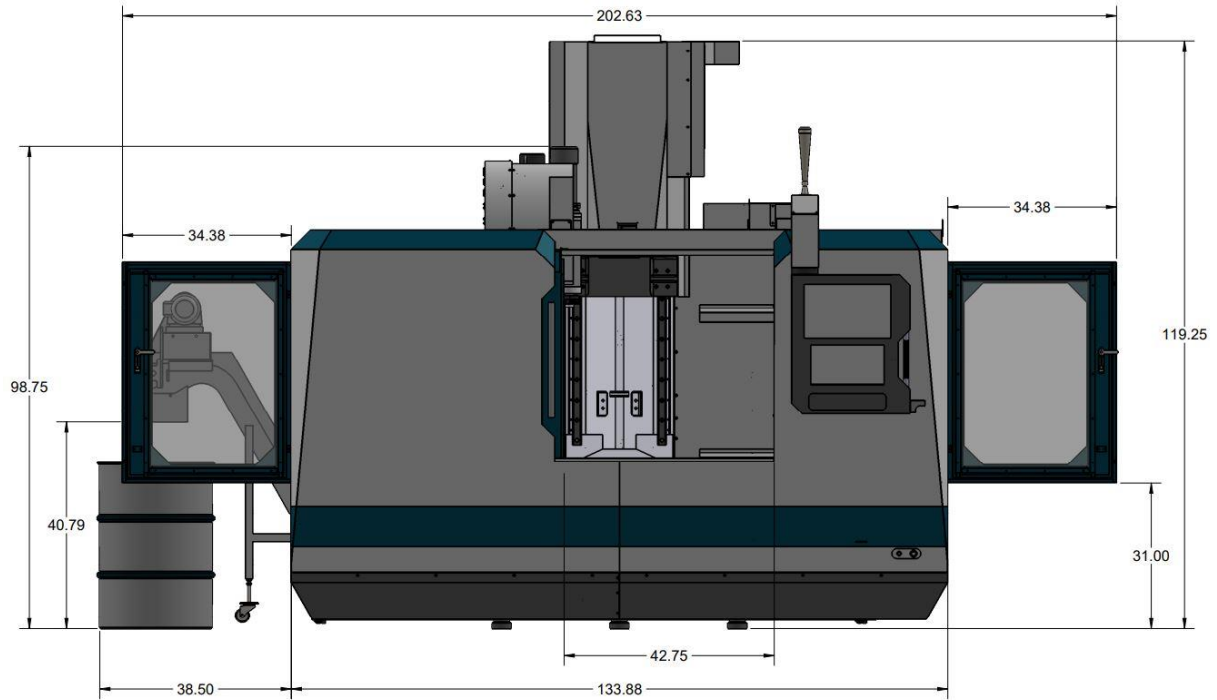

VMC12si Front View

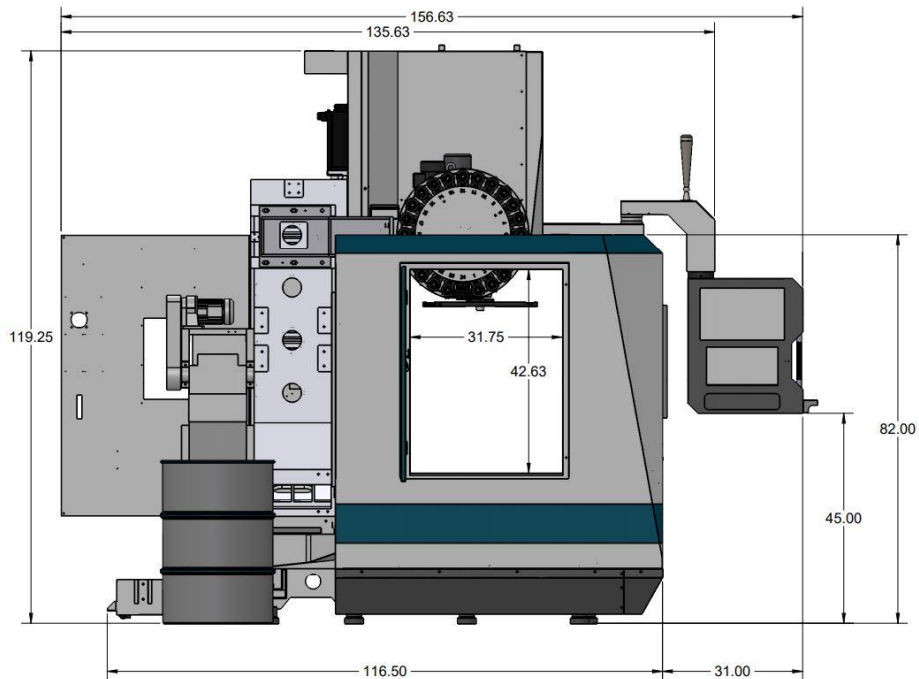

VMC12si Left Side View

VMC14si

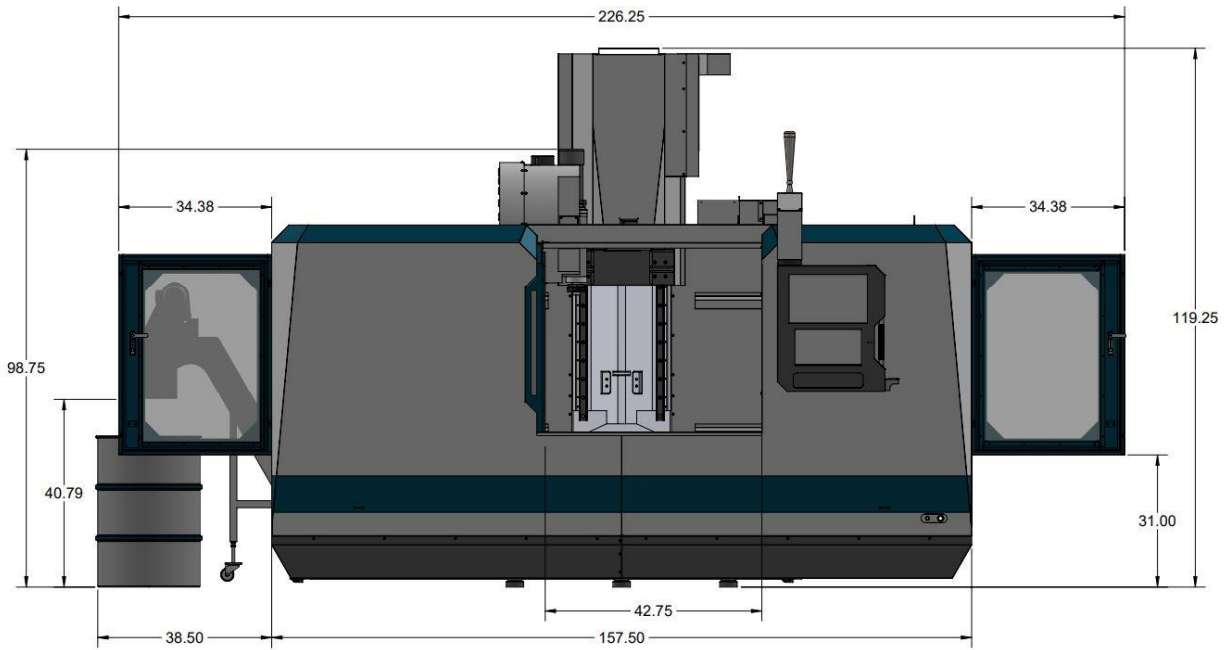

VMC14si Front View

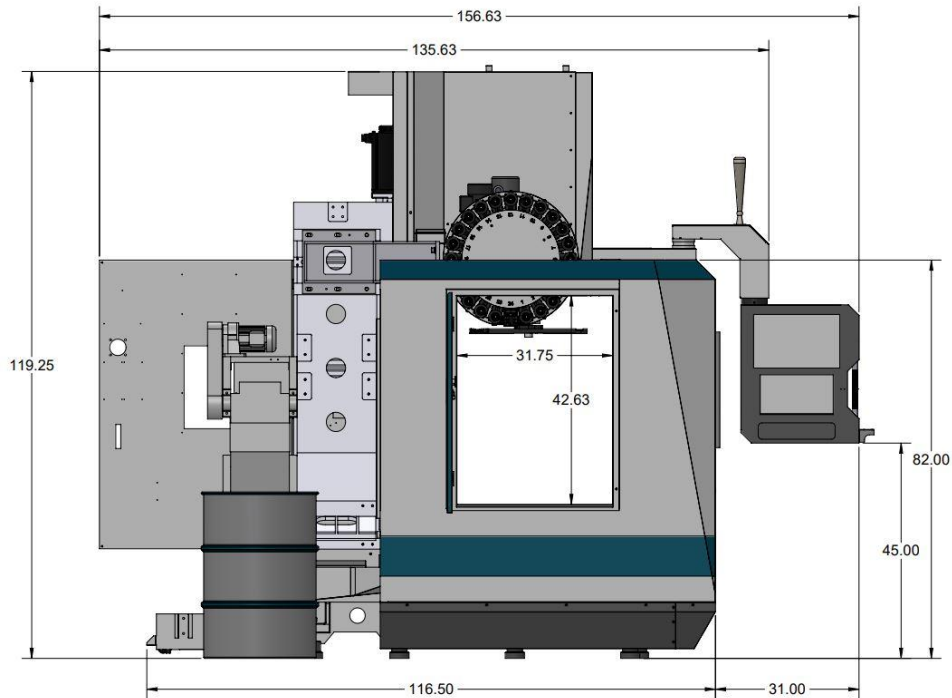

VMC14si Left Side View

2.5 Uncrating the VMCsi

1. Remove the loose articles from the pallet and check them against the loose Inventory Checklist (Section 2.7).
2. The tool measurement cart kit and the tooling pre-setter will require some assembly. Instructions to assemble will be found in the kit. (Optional Equipment)
3. Remove the 2 M6x15 SHCS that secure the pendant base, remove the bracket, swing out the pendant and remove protective covering (See figure 2.5a).
4. Remove the 5 M6x15 SHCS that secure the saddle and table support brackets, and remove the brackets (See figure 2.5.b)
5. Remove the 4 M12x40 SHCS that secure the column support bracket from the table and the head, but **DO NOT ATTEMPT TO REMOVE THE SUPPORT AT THIS TIME**. (See figure 2.5.c)
6. Remove the 4 M6x16 SHCS that secure the front door (see Figure 2.5.d).



Figure 2.5a



Figure 2.5b

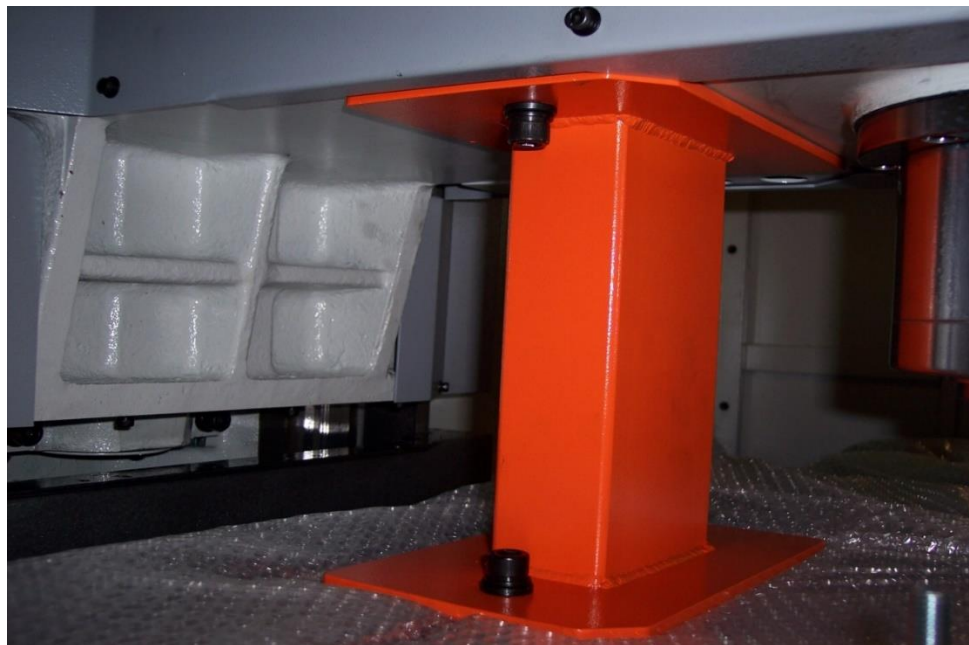

Figure 2.5c



Figure 2.5d

2.5.1 Releasing the Head Support Bracket

1. Start with VMCSi machine under power.
2. Remove screws from head support that attach to the table and ram as shown in figure 2.5c.
3. Press feed enable and reset on the Machine Control Panel (MCP).
4. Adjust feed rate, use EHW, select Z axis using X1 slow speed.
5. Slowly rotate Z EHW clockwise to raise Z Axis off head support bracket.
6. Remove support.

2.6 Leveling Procedure

Leveling the VMCSi in the field consists of leveling the machine and then adjusting the level, if necessary, to make sure the tram of the spindle is perpendicular to the table. Refer to figure 2.6.1a, or 2.6.1b for the Leveling Pad Dimensions and Locations for your specific VMCSi.

2.6.1 Leveling Pad Specifications

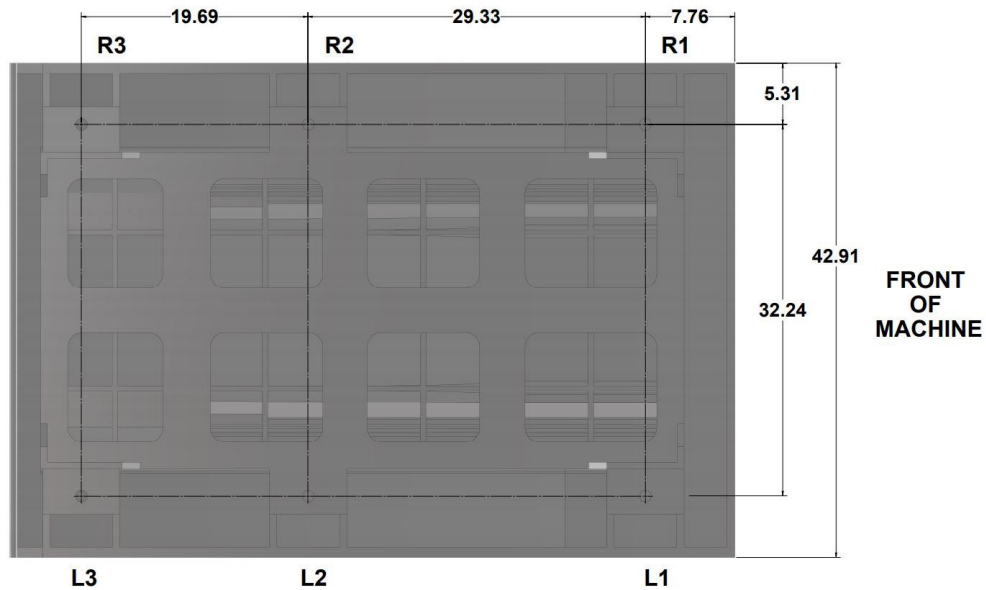

Figure 2.6.1a - VMC7si and VMC10si Leveling Pad Dimensions

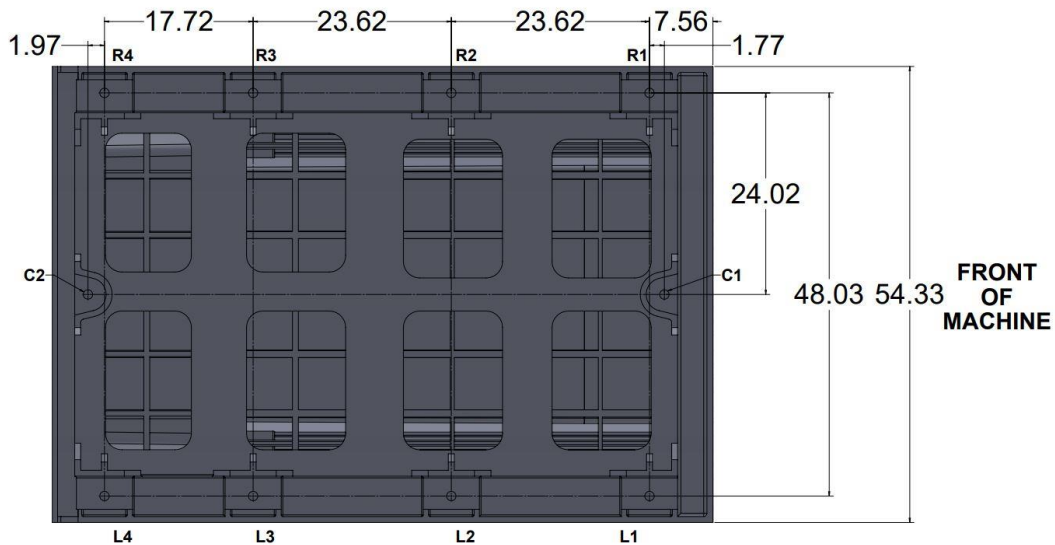

Figure 2.6.1b – VMC12si and VMC14si Leveling Pad Dimensions

2.6.2 Leveling and Tram Procedure VMC7si and VMC10si

1. Set the VMC7si and VMC10si machines on its 4 leveling pads L1, L3, R1, & R3 on a solid, level floor prepared in accordance with the state and local rules for machine tool installation.
2. Clean the table thoroughly and place 1 or 2 precision Spirit levels or electronic levels in the center of the table in the positions illustrated in figure 2.6.2b.

CAUTION!

If using 2 levels, make sure each level is measuring correctly. To check, place the level in one direction and note reading and then flip 180° and see if the reading is the same. If not, have the level recalibrated.

3. On the VMC7si and VMC10si, leveling is achieved by using leveling screws R1, R3, L1 and L3. See figure 2.6.1b. Adjusting screws R2 and L2 should be left loose with the leveling pads and have no pressure at this time. A 36 mm wrench is required to adjust the leveling bolts.

4. With the precision levels placed on the worktable as shown in 2.6.2b, level the VMCsi to within 0.0005"/10 in.
5. If the machine must be anchored to the floor, follow the general instruction for installing machine tools when anchoring.
6. If the machine must be installed on vibration mounts/pads (rubber, commercially available leveling and vibration mounts, etc.) follow the instructions delivered with the mounts/pads, ordering them to satisfy the load of the machine and the maximum weight of the workpiece (~10,000 lb.).
7. When machine is correctly leveled, lock the adjusting screws in place with their hex nuts. See figure 2.6.2a.



Figure 2.6.2a



Figure 2.6.2b

Adjusting Level for Tram VMC7si and VMC10si

1. Mount the .0001" test indicator to the spindle nose and sweep the table with a 12" span (6" radius).
2. If the tram measurement is not .0008 TIR on the VMC7si and VMC10si, adjust the R3 and L3 leveling bolts to adjust the tram within specification. This will tend to help adjust any error you have in the X and Y axis for the tram. By adjusting these bolts, you can in affect slightly affect the column and bring in the tram.
3. Once complete, lock all leveling screws in place with the lock nuts. See figure 2.6.2a

2.6.3 Leveling And Tram Procedure VMC12si and VMC14si

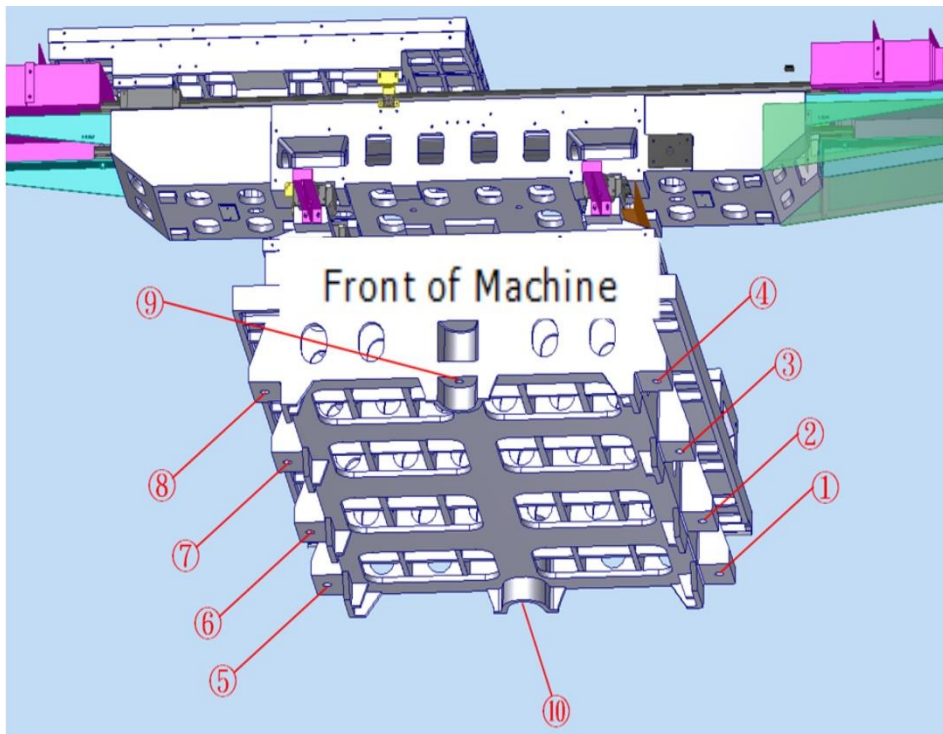

Figure 2.6.2.c Model of VMC12si and VMC14si base and casting table, viewed from the front. We will be using these number designations to identify and callout each leveling screw.

The VMC12si and VMC14si are much larger than our standard machining centers, are a bit more sensitive to leveling screw adjustments. The additional mass of the machine affects the process and can make the machine sag or flex unpredictably if not done in a controlled manner. See figure 2.6.2c for details.

Note: Due to high level of force needed to adjust leveling screws, it is suggested get a wrench with a long handle.

Steps to level the machine –

1. Using the bubble or digital level on the table, level the machine to spec (.0005" over 10") using the outside 4 leveling screws (1, 4, 5, 8).
2. Check front to back tram to be within .0008". If not within this range, adjust rear leveling screws (1, 5) to push or pull on the column, relative to the table.
3. Now, check left to right tram to be within same range. Adjust using front two leveling screws (4, 8). This will lift or lower the table, relative to the Z-column casting.
 - a. We have found many machines to actually have a twist rather than a simple planar error. This twist can be compensated by either lowering the high end of the twist, or lifting the low end of the twist. Most machines have had a high spot that required being lowered. The larger mass of this machine allows you to lower the high corner and it will sag to straighten the casting.

4. Recheck F/B and L/R tram to be within spec. This process may need to be repeated if the floor surface is less than ideal.
5. Touch off inner 4 leveling screws (2, 3, 6, 7) and the front and rear centerline leveling screws (9, 10).
6. Complete a final check of tram to make sure values are within spec.
 - a. Tram should be .0008" or less over 12".

2.7 Shortages: Inventory Checklist

The following items will come standard with the VMCsi. Please note any optional items that have been ordered are present.

Unassembled Components Checklist:

Boxed Parts See figure 2.7a

- (1) Self-coiling air hose – P/N 26961
- (1) Air nozzle – P/N 26960
- (1) Coolant nozzle and fitting – P/N 26958
- (1) 10' 120 PSI rated hose – P/N 26959
- (1) Air and coolant nozzle bracket



Figure 2.7a - Boxed Parts Photo

Tool Box Contents See figure 2.7b

- (1) Toolbox – P/N 27646
- (1) 36mm Open End Wrench – P/N 27643
- (1) Tool Changer wrench – See Section 4.8 for more information
- (2) Leveling pads some boxed on pallet, some under mill, some in toolbox

Note - (6) Leveling pads are shipped with VMC7/10si, (4) are located under the mill, on the pallet when delivered, and (2) are included on the pallet. VMC12/14si come with 10 pads, (4) are located under the mill on the pallet when delivered, and (6) are included on the pallet. See figure 2.7c showing the size difference, left sample is VMC7/10si and right sample is VMC12/14si.



Figure 2.7b - Loose Parts Photo



Figure 2.7c

Unassembled Large Components shipped Inside or with VMCsi

(4) Skirts

(1) X & (2) Y Axis Covers

(1) Large Coolant Tank with coolant and coolant wash pumps installed

(1) Mills equipped with CTS will have the pump in a separate box (**Warning:** Pump is 100 lbs use crane.)

(1) Conveyor motor and chute

Brackets fastened to machine and need removal

Warning: See section 2.14 Installation Checklist before starting to disassemble

(1) Pendant support bracket

(1) Column support bracket

(1) Bed shipping bracket

(1) X-axis shipping bracket

2.8 Electrical Connection

The VMC7si, VMC10si, VMC12si, and VMC14si all come standard requiring 480 volts. VMC7si and VMC10si can receive input 3 phase 208 voltage (198-218 acceptable) with the factory-installed 208 volt to 480 volt transformer option.

TRAK Machine Tools recommends the machine be earth grounded by driving a copper rod into the ground. It is the responsibility of the customer to install this rod see figure 2.8.1.

DANGER!

Only a qualified electrician should wire the electricity for your mill installation.

2.8.2 Main Power to the Machine Connections

Connect the ground wire as shown in the figure 2.8.1.

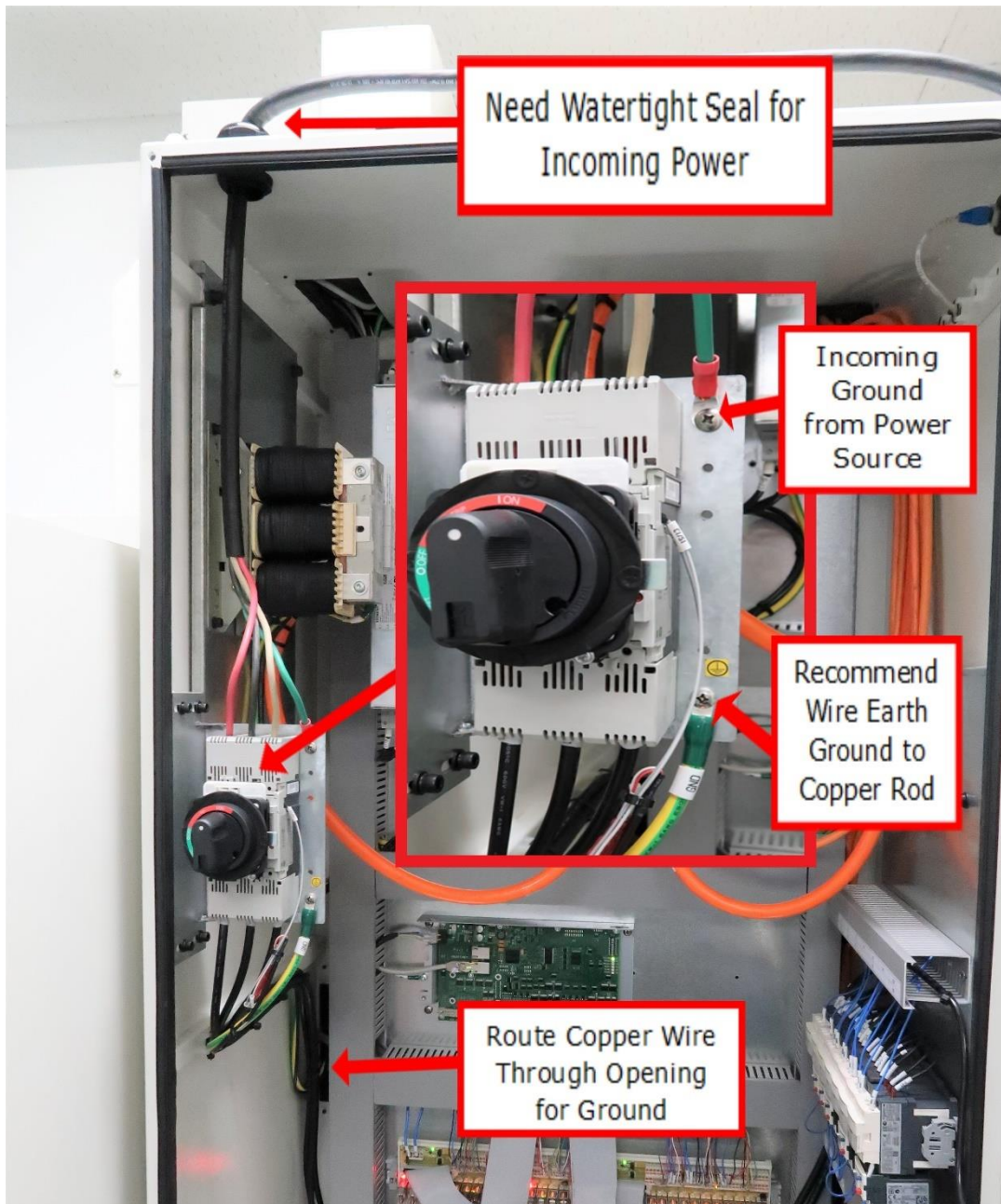

Figure 2.8.1

2.8.3 Transformer Option Requirements

All TRAK VMCsi models require 480 volt power for operation. VMC7si and VMC10si can receive input 3 phase 208 voltage (198-218 acceptable) standard connected to L1, L2, and L3 at the input breaker. Customers with 208 Voltage available require a 208 volt to 480 volt transformer.

The available transformer option for VMC7/10si customers that only have a 208 volt power source in their shop is shown in figure 2.8.2. The transformer steps up 208 volts to 480 volts.

There are three taps available on the transformer option, 208, 220, and 240. Installer should measure the incoming voltage and connect L1, L2 and L3 to the correct tap based upon the closest available voltage at the customer's facility see figure 2.8.3 for the details.

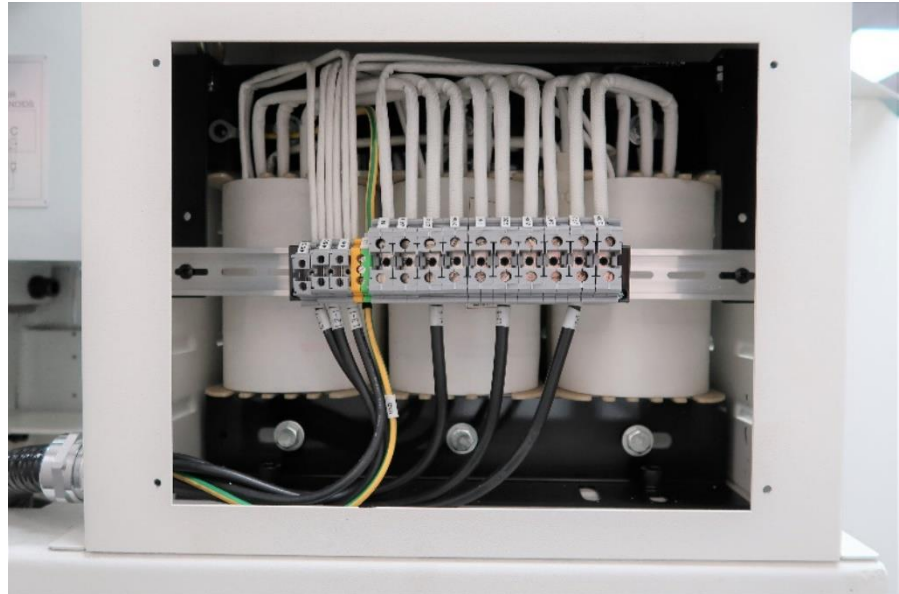

Figure 2.8.2 VMC7si and VMC10si Transformer Option

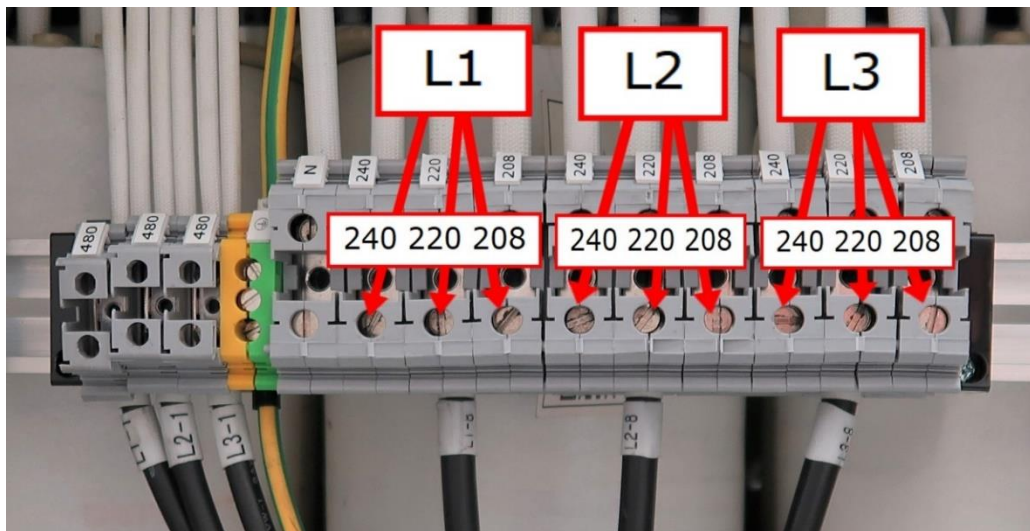

Figure 2.8.3 Taps Based Upon Input Voltage

2.9 Air Connection

Connect the air supply to the quick disconnect coupling to the left of the pressure regulator and beneath the in-line air switch. The air supply line should have a minimum of 1/2" inside diameter. It is recommended that a water separator or air dryer be installed upstream of the VMCsi air supply.

2.9.1 Air Regulators and Solenoids

The VMCsi consists of 2 air regulators, 3 air flow valves and 3 solenoids. They are all set at the factory and should be checked upon installation.

The main air regulator for the machine should be set at 90 psi and the secondary one that supplies air to the spindle cartridge should be set at 7 psi. These regulators are adjusted by pulling the cap upward and rotating the cap clockwise to increase the air pressure and CCW to decrease the air pressure.

The in-line air switch shown in figure 2.9.1a turns the system air on and off on the VMC7si and the VMC10si located at the rear of the mill. Air switch for the VMC12si and VMC14si is installed on the left rear of the mill see figure 2.9.1b. Put the blue collar in the lowered position (off) before connecting the air supply. Push upward to turn on the air.

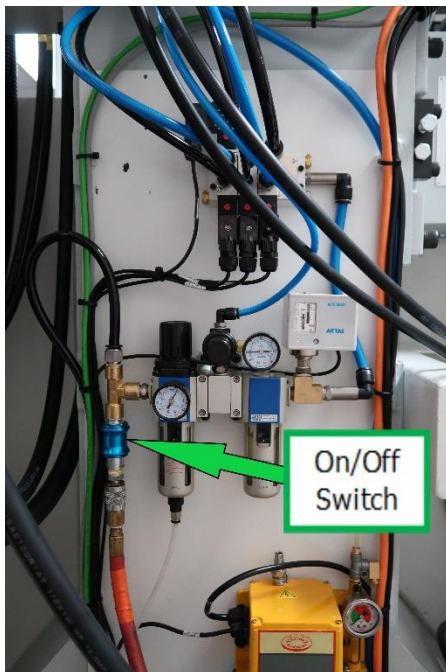

Figure 2.9.1a

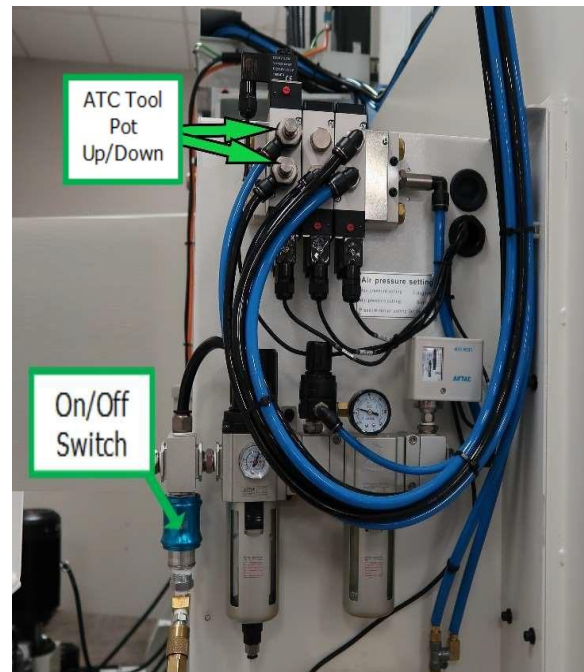

Figure 2.9.1b

For the Flow Control Valve that controls the tool change air blast, close this valve and open it 6 or 7 turns and then lock it in place as shown in figure 2.9.1c.

There are 2 valves that control the speed by which the ATC lifts and lowers the ATC pots, they should be opened all the way and locked in place as shown in figure 2.9.1b.



Figure 2.9.1c

2.10 Placing the Coolant System

1. Locate coolant tank beneath the rear of the machine.
2. Remove loose ends of coolant hoses from the underside of the VMCsi enclosure and route them to the pumps. The hoses and fittings are labeled prior to shipping.

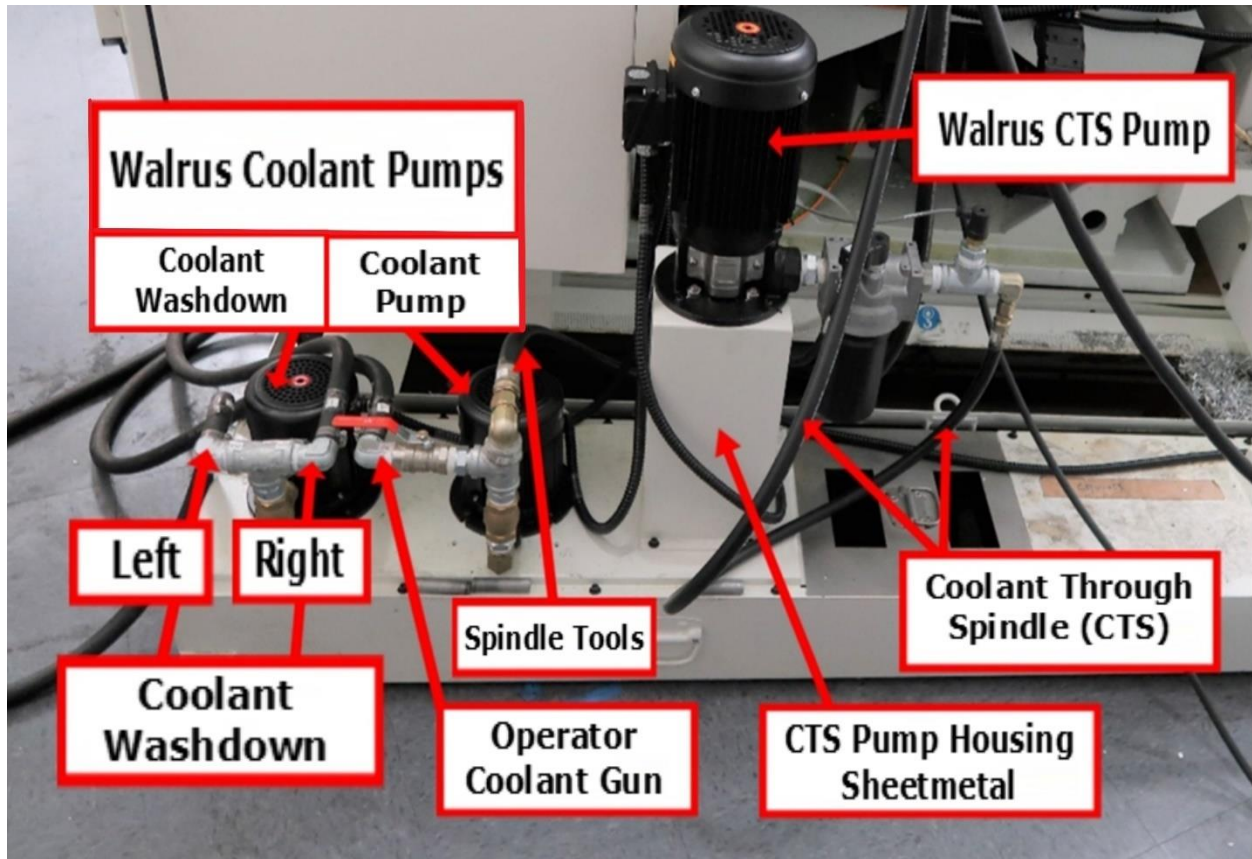

Figure 2.10a

- Attach and secure these hoses with hose clamps per the figure 2.10a. Wires on mills using 480v power, are routed through the electric cabinet with the coolant pump wired to overload Q5, coolant wash down pump wired to overload Q20, and the optional CTS pump wired to overload Q21 as shown in figures 2.10b and 2.10c. Connections are labeled with letters and have specific colors (left to right), U = brown, V = blue, W = black with the yellow/green stripe ground wire connected to back panel. Inset of the figures show the specific wire location points. Wires are attached to the bottom of the overload where a clamp screws in toward the back of the cabinet. It takes quite a few turns to tighten.

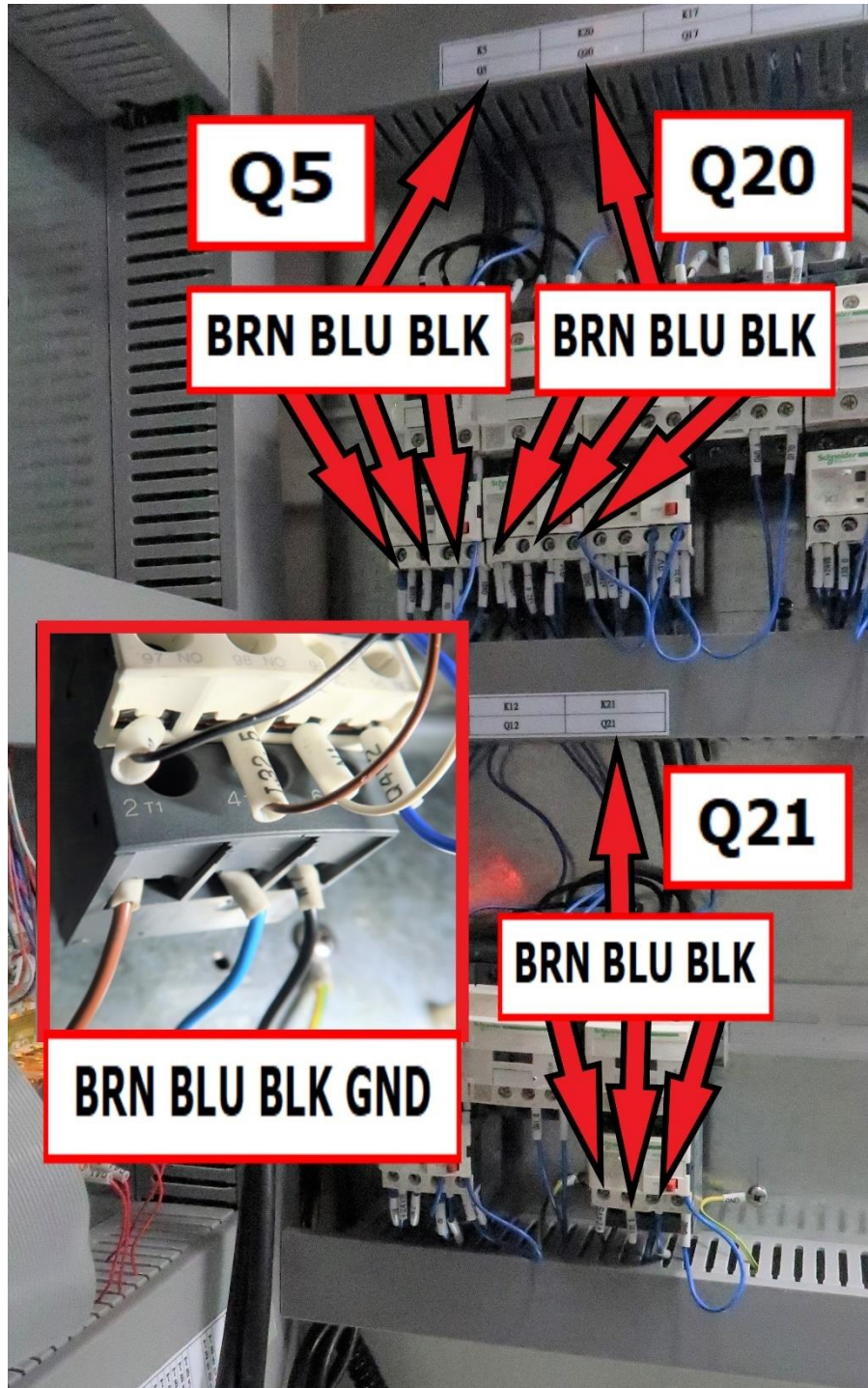

Figure 2.10b VMC7/10si Coolant, Coolant Wash Down and CTS Wiring

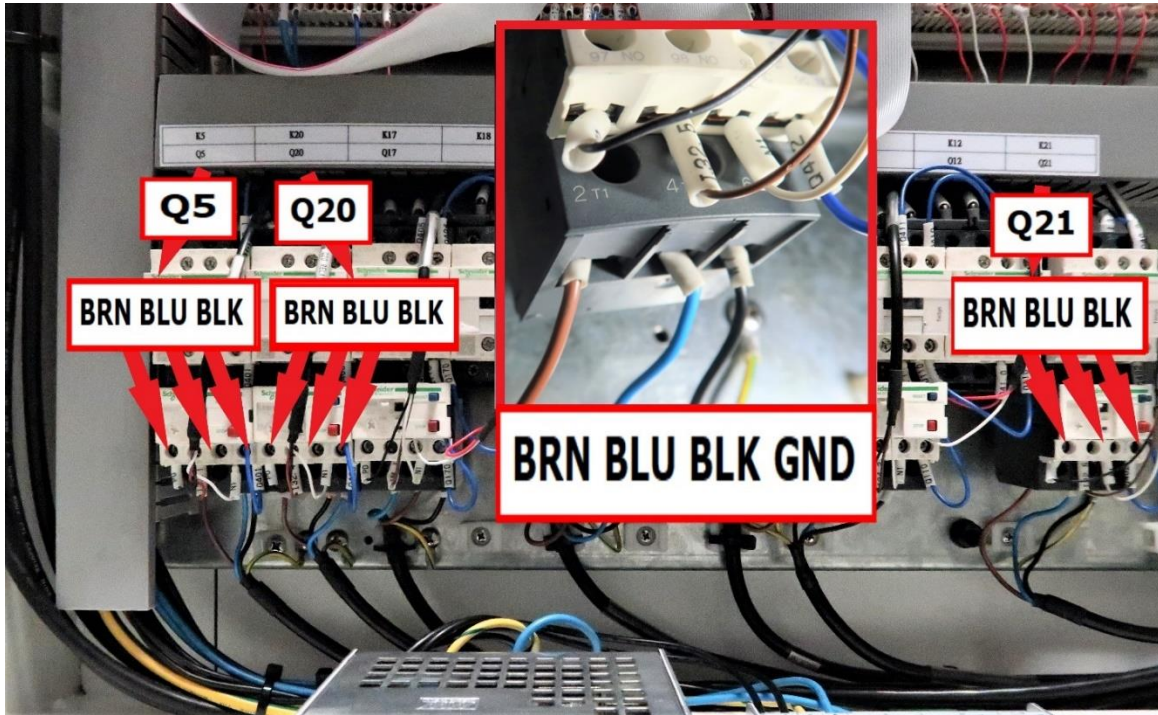

Figure 2.10c VMC12/14si Coolant, Coolant Wash Down and CTS Wiring

Wires on mills using 208V power with CTS includes the soft starter SSR1 which is shown in figure 2.10d. SSR1 replaces K21 and Q21 on 208V VMC7/10si machines. Refer to drawing 34082 for installation details.

Wires on mills using 208V power have the CTS pump wired to soft starter SSR1 as shown in figures 2.10e.

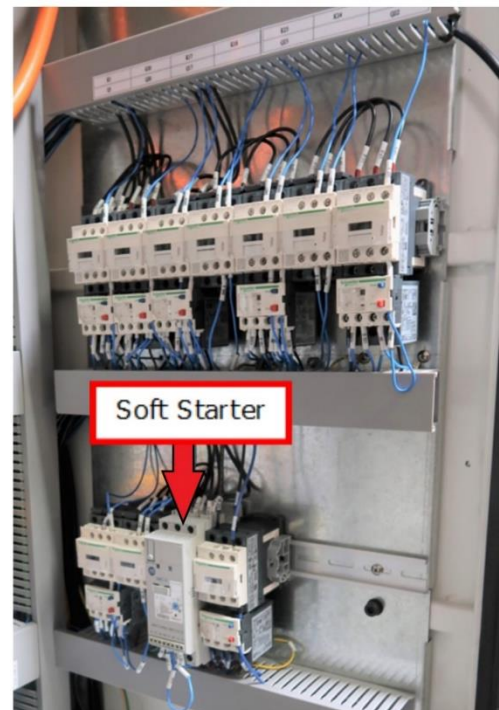

Figure 2.10d VMC7/10si with 208V power

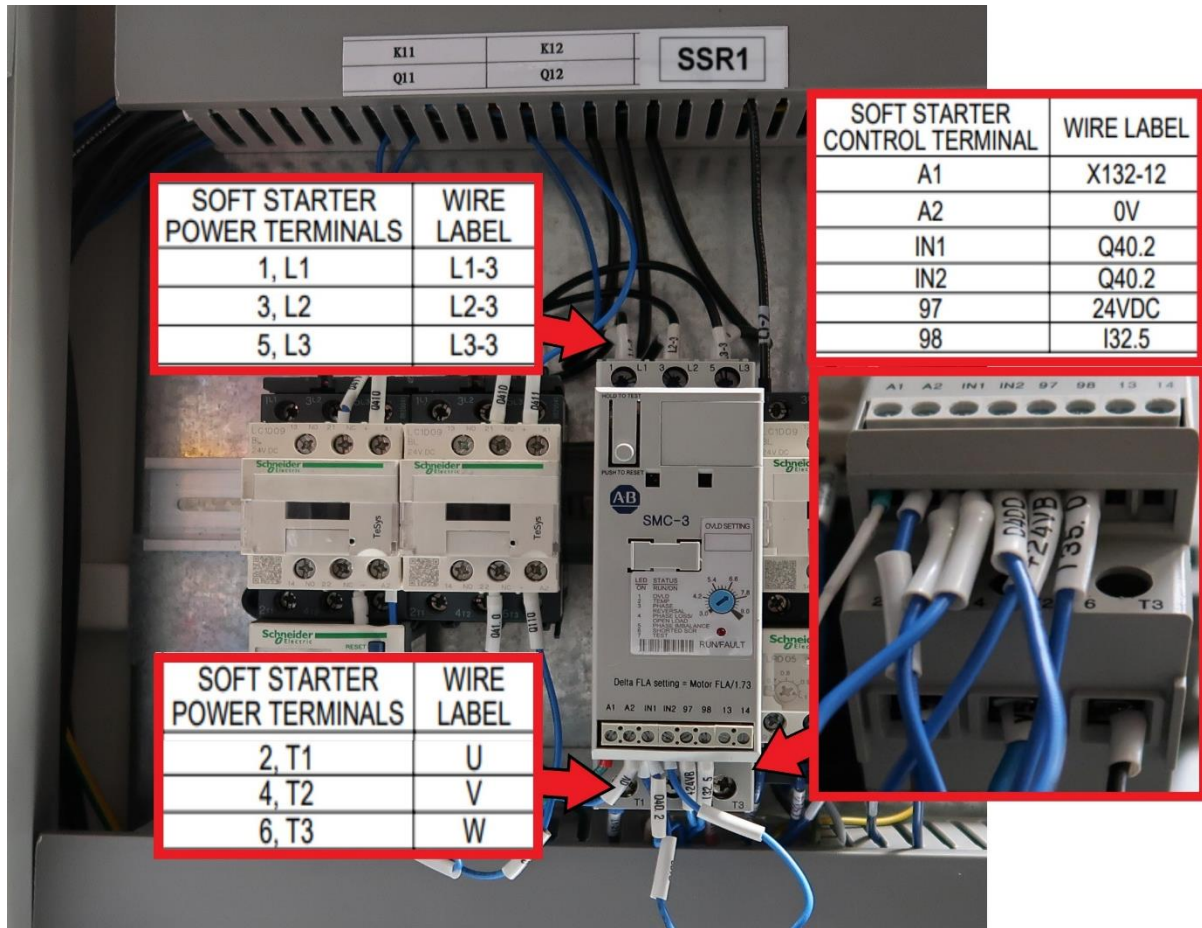

Figure 2.10e VMC7/10si 208V, Coolant, Coolant Wash Down and Soft Starter CTS Wiring

2.11 Placing the Coolant Through Spindle (CTS) System

WARNING!

Do not lift CTS pump without hoist!

The coolant through the spindle pump weighs about 100 pounds and it is cumbersome because of its shape to handle. Use a lift, hoist or crane to guide the pump into position.

1. CTS pump and housing sheet metal support are shipped separately from the large chip tray. Locate the housing and bolt into position as shown in figure 2.10 and 2.11b. The needed bolts are attached to both the housing and pump.
2. Attach the filter, pressure sensor and fittings assembly to the CTS pump as shown in figure 2.11a.

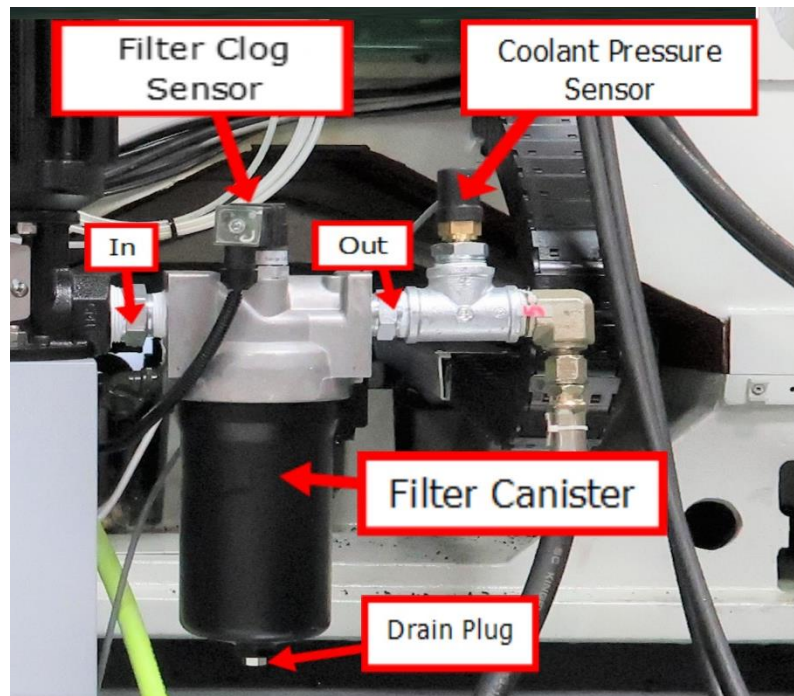

Figure 2.11a

3. A hose needs to be routed from the coolant pressure sensor to a bracket as shown as hose #6 in figure 2.11b.
4. The power wires are routed thru the rear opening in the electrical and connects to relay Q21 see figure 2.10c.

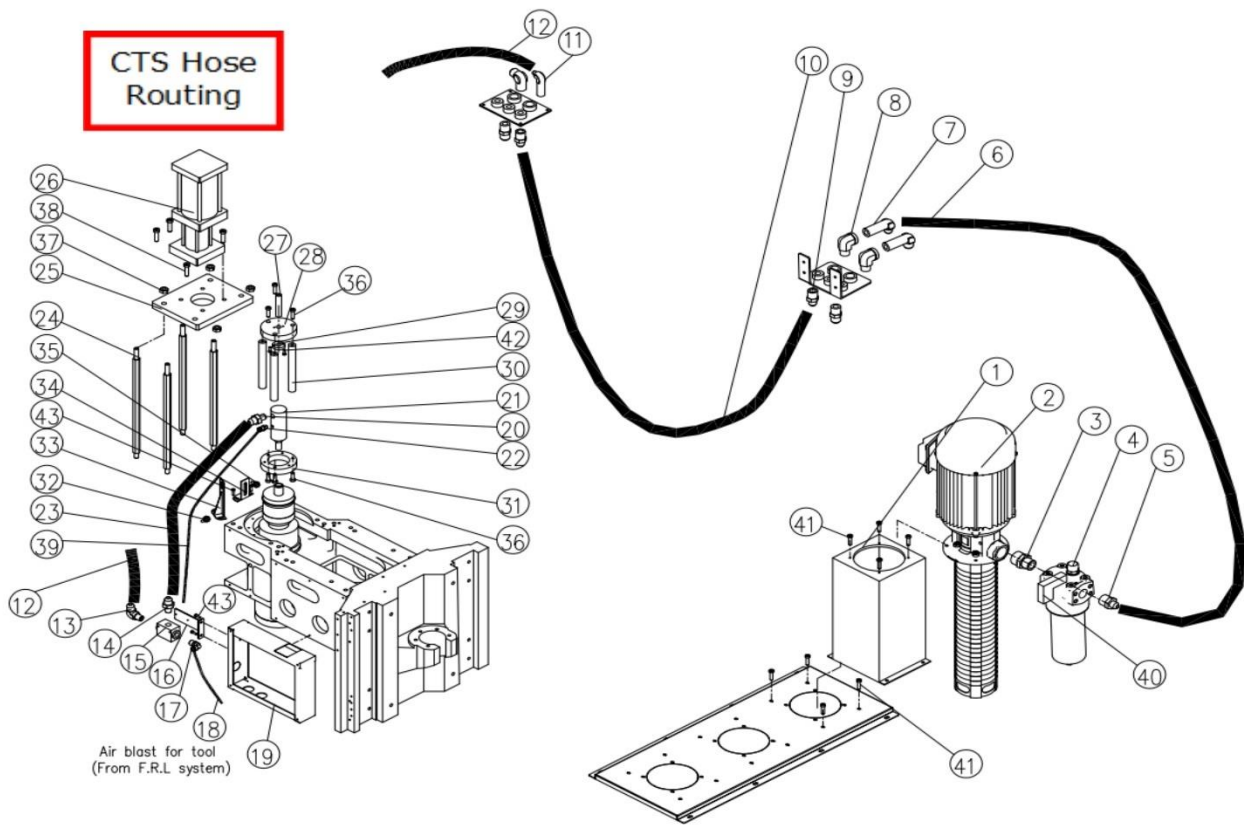

Figure 2.11b

5. Wires for both the Filter Clog Sensor and the Coolant Pressure Sensor are tie wrapped to the rear of the electric cabinet. Connect the Filter Clog Sensor to the top of the filter see figure 2.11a.

6. Loosen the cord grip on the Pressure Sensor Cap and slide out enough wires to make connections as shown in figure 2.11c. Connect the wires to the sensor as shown in figure 2.11d. Leave the cover off for now.

7. Calibration of the Pressure Sensor was done at the factory. Instructions are included here in case there is a need to recheck calibration. Calibration requires power to the mill. Remove any tool currently in the spindle. Note the 'Calibration' screwdriver in figure 2.1c. which shows where to adjust sensor calibration. Make sure the mill is running, enable CTS, you will need to watch the pendant. Use a small flat blade screwdriver to tighten this screw slowly, about 1/8th of a turn a second. When the machine faults as shown in figure 2.11e, loosen the screw 1/4 turn and clear the fault on the pendant.

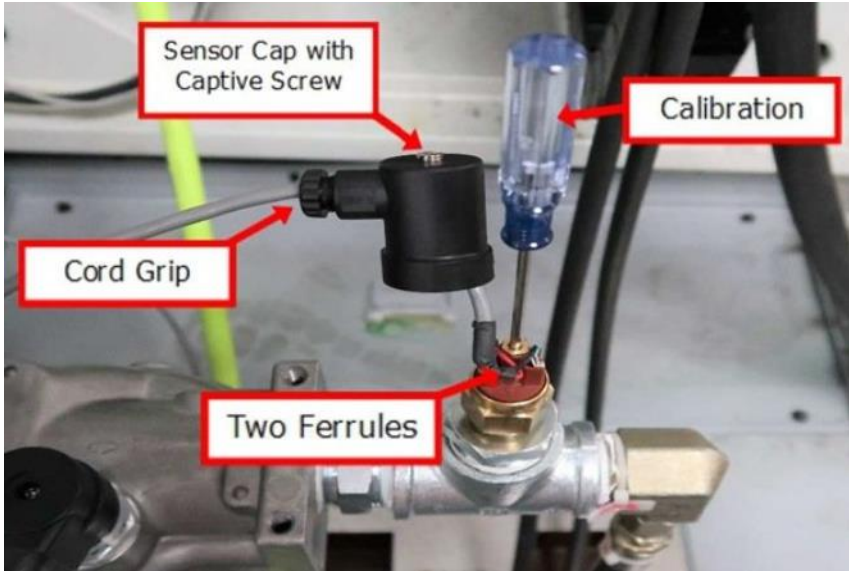

Figure 2.11c



Figure 2.11d

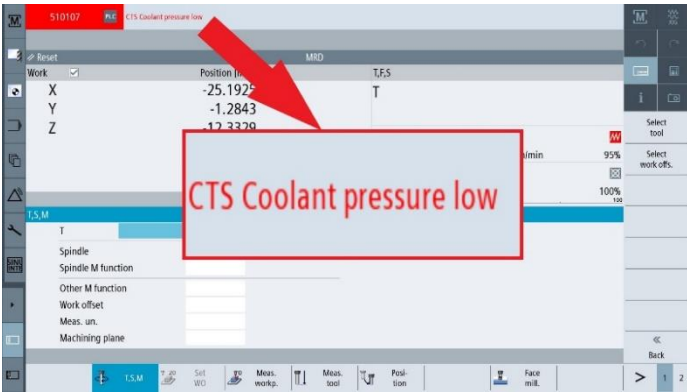

Figure 2.11e

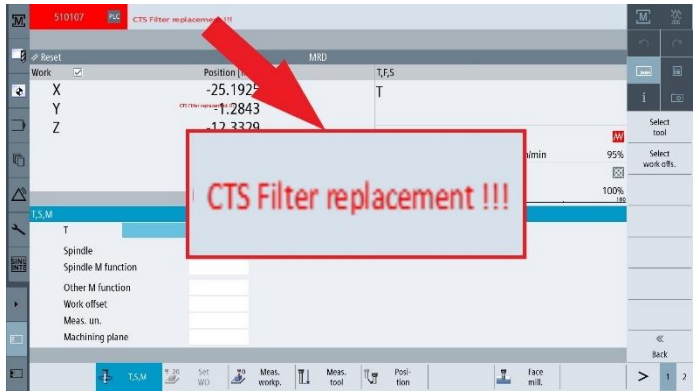

Figure 2.11f

8. Test the Filter Clog Sensor with the mill running and CTS enabled, unplug the Filter Clog Sensor wire shown in figure 2.11a and check the screen for the message shown in figure 2.11f. This message is a warning and does not cause the mill to stop operations. Secure the screws and cord grip used in these steps.

2.12 Placing the Chip Conveyor System

WARNING!
Do not lift Conveyor pump without hoist!

Initial installation of the Chip Conveyor will require a lift. There are four lift points on the conveyor, one hidden from view in figure 2.12a. Once on its wheels, the conveyor is easy to roll behind the mill. There is a gasket that runs along the bottom casting of the spindle area. This gives you a general alignment location for the chip conveyor to be installed behind the VMCSi machines. Careful alignment is done when you align the conveyor with the chip dispersion ducts. The ducts must empty into the chip tray. See figure 2.12b.

Figure 2.12a

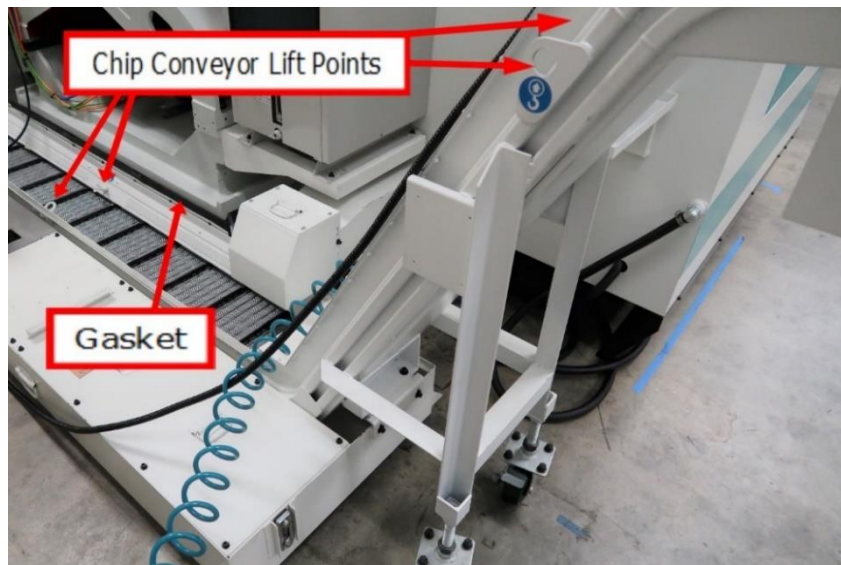

Figure 2.12b



2.13 Optional Skimmer System

Click [here](#) for drawings for the Skimmer System.

2.14 Installation Checklist

Installer – Use this checklist to assure a complete setup on the VMCsi.

Installation Checklist	
<input type="checkbox"/>	1. Shut off power to the machine.
<input type="checkbox"/>	2. Visually inspect the 480-volt wiring (or 208-volt if transformer option is installed) going into the electrical panel. Visually verify the wiring is correct per our wiring diagram and the voltage is between 456 and 504 volts. In the case the customer has the 208-volt option, inspect the wiring and the voltage is between 198 to 218 volts. Make sure a strain relief is being used where the wiring enters the cabinet. Have the customer repair any wiring discrepancies. See figure 2.8.1. Double check how the machine has been grounded and notify user if it is not done per our recommendations. See section 2.8.1 for recommended grounding.
<input type="checkbox"/>	3. If 208-volt step up transformer option is installed, measure incoming voltage and adjust transformer taps as necessary. The goal is to have the voltage at the input of the Smart Line Module to be close to 480 volts. See sections 2.8.2 and 2.8.3.
<input type="checkbox"/>	4. Clean the machine if needed and remove any remaining protective grease.
<input type="checkbox"/>	5. Unlock table, saddle and head by removing support brackets. Install door handle on front door.
<input type="checkbox"/>	6. Turn on the power to the machine. Verify the lube pump cycles 1 time when machine is turned on. Move the machine as required to prepare for leveling.
<input type="checkbox"/>	7. Prior to leveling, confirm each leveling bolt is approximately 1.25" down as measured from the bottom of the leveling bolt to the bottom of the casting. 
<input type="checkbox"/>	8. Check the level of the machine. The machine should be level to within 0.0005"/12 inches front to back and 0.0005"/12 inches side to side. Adjust leveling feet as necessary to adjust for the spindle tram should it be out of spec. Refer to section 2.6 for leveling details.
<input type="checkbox"/>	9. SLM Recommissioning: Set access level to Manufacturer, press E-STOP.

Installation Checklist

10. SLM Recommissioning cont: Go to "Machine configuration" window, #1 press HSK "Drive System" then #2 press HSK "Supply". The "...\Infeeds\Overview" window

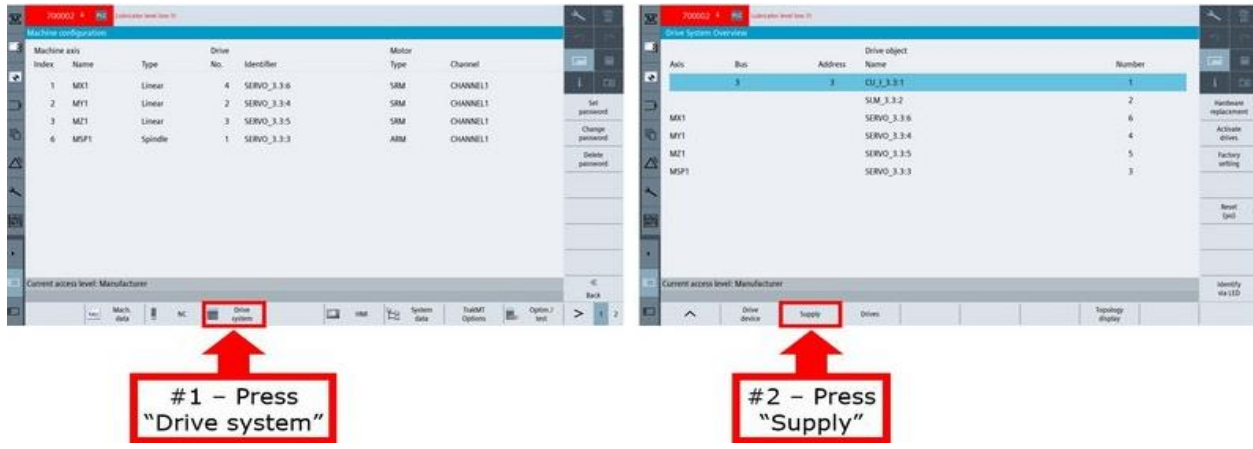

appears, as shown at right press VSK "Power data".

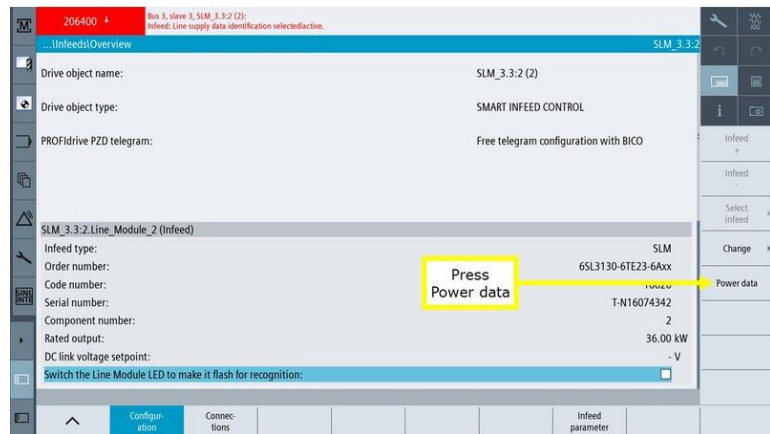

The "...\Infeeds\Configuration-Power data" window appears, #1 Check the box for "Line/DC link identification on first Power ON", then #2 set the "Device supply voltage" to "480V". #3 Next press VSK "Accept" to continue as shown to the right.

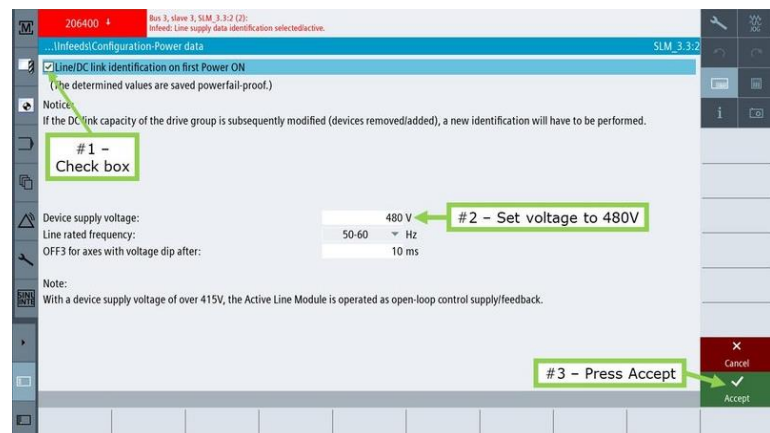

Installation Checklist

11. SLM Recommissioning cont: The "Infeed" window appears. Press VSK "Yes" to save the data. The quick commissioning message will appear on the screen, and the control will set infeed parameters p210, p211, p281, and p283 automatically.

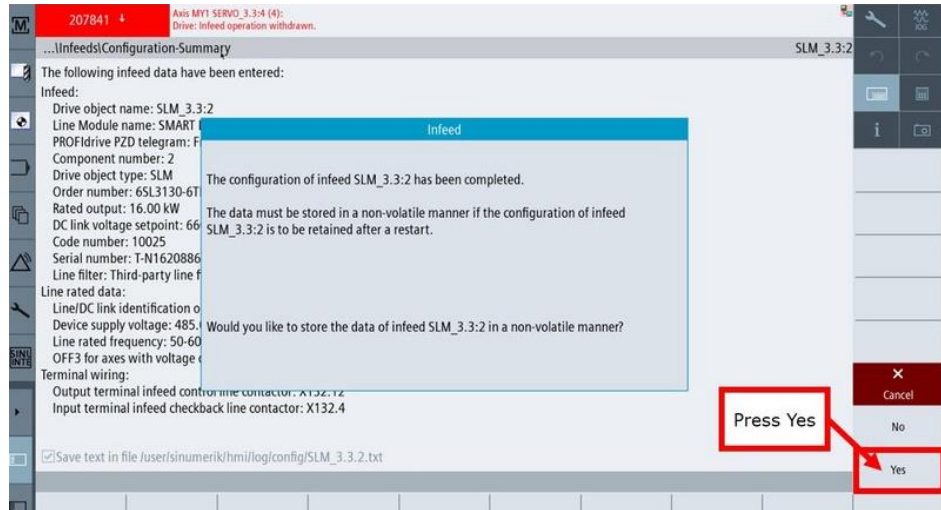

12. Install the conveyor to the coolant tank if the rigger has not done so already.

13. Prior to adjusting the final level on the machine, slide the coolant tank under the machine with the coolant chutes in place. Make sure the slots on the chutes are all the way up as shown. Now lower the chutes down as shown in picture.



14. Install the CTS pump and filter assembly to the coolant tank

15. Power down the machine and wire up the external pumps to the overloads in the electrical cabinet. The conveyor motor is wired to Q11, coolant pump to Q5, coolant wash pump to Q20 and CTS pump to Q21 on 480V mills. For 208V mills, the CTS pump is wired to Soft Starter1 (SSR1). Please also connect the CTS pressure sensor and CTS pressure differential sensor per sections 2.11a, 2.11b, and 2.11c.

16. Install the 2 CTS sensors – CTS filter clog sensor and CTS pressure sensor. See section 2.11 for instructions.

17. Adjust air pressure on the main air regulator to 90 psi. Adjust air regulator for the spindle cartridge to 7 psi.

Installation Checklist	
<input type="checkbox"/>	18. Install the 7 coolant hoses that pertain to the coolant pump, coolant wash pump and CTS pump as they are removed during shipment. Install hoses labeled 1 through 7 to the corresponding fittings labeled 1 through 7. Refer to sections 2.10, 2.11a and 2.11b.
<input type="checkbox"/>	19. Run the lube pump using the button on the MCP (Machine Control Panel) and make sure the ballscrew and linear guides are getting oil.
<input type="checkbox"/>	20. Jog the X, Y and Z axis back and forth until the linear guide surfaces are well lubricated. Oil should be visible on all the linear guide surfaces and ball screws. Once lubrication is verified, attach all way covers.
<input type="checkbox"/>	21. Go to JOG mode and move each axis in a positive direction. Select the X axis on the MPG, does the table move to the left when turning EHW CW? Select the Y axis on the MPG, does the saddle move toward the operator when turning the EHW CW? Select the Z axis on the MPG, does the head move up when turning the EHW CW?
<input type="checkbox"/>	22. Final test each axis by using the JOG button with RAPID button. Verify the machine does not hit the hard stop on the machine. Adjust parameters 36100 (-) and 36110 (+) on the axis in question if you do hit a hard stop.
<input type="checkbox"/>	23. Install Y axis way cover bracket between front and rear way cover. Install the lower 3 sheet metal skirt covers on the front and sides of the machine.
<input type="checkbox"/>	24. Check to make sure that the E-Stop button is functioning correctly. Turn spindle on and jog an axis and press the E-stop button during this operation and verify the spindle and axis stops. Make sure the Z axis does not move when the E-stop is pressed. The brake on the Z axis motor will hold the head.
<input type="checkbox"/>	25. Turn the chip conveyor on in the forward and reverse directions and make sure it moves in the correct direction. You need to hold the REVERSE key down for the conveyor to turn in reverse.
-	26. Turn the coolant wash pump on by pressing the button on the MCP and make sure it rotates in the correct direction (Clockwise). Note - <i>Coolant coming out of the wash down nozzles is not an indication that the pump is turning in the proper direction. Observe the direction of the motor fan.</i>
<input type="checkbox"/>	27. Install the coolant and the air hoses to the front of the machine. Confirm the bracket to hold these hoses is installed on the right side of the pendant enclosure. Confirm both hoses work and do not leak.
<input type="checkbox"/>	28. Turn the coolant pump on by pressing the coolant button on the MCP and make sure it rotates in the correct direction (Clockwise). Note - <i>Coolant coming out of the nozzles is not an indication that the pump is turning in the proper direction. Observe the direction of the motor fan.</i>
<input type="checkbox"/>	29. Turn the CTS pump with a button on the MCP and make sure the pump runs in the correct direction. Run coolant through the system and make sure there are no leaks at any of the joints. Check pump/filter assembly, mounting points for hoses, shuttle valve, and rotary joint. Tank must be full.
<input type="checkbox"/>	30. Set coolant pressure sensor by running CTS with no tool in the spindle. Slowly tighten adjustment screw in center of sensor, until machine errors out and pump shuts off. Test again to confirm setting location. Loosen screw 1/2 turn. Turn pump back on and check for leaks again after 10 minutes of runtime.

Installation Checklist	
<input type="checkbox"/>	31. Turn the AIR blast on by pressing the button on the MCP. Open and close the valves and make sure there are no leaks.
<input type="checkbox"/>	32. Is the spindle motor fan running? Is it turning in the correct direction? Air should be blowing down towards the motor.
<input type="checkbox"/>	33. Close the door and make sure the control recognizes the door as being closed. Once you close the door, you should not be able to open it until you press the door open button on the MCP. Turn the spindle on and make sure the door locks and it cannot be open when the spindle is running.
<input type="checkbox"/>	34. Press the manual tool change button on the head (GREEN button) and make sure air is coming down through the spindle. Adjust as required. Put a tool in the spindle and verify the tool clamps once the green button is released.
<input type="checkbox"/>	35. Move the ATC completely around all 24 stations using the MCP button called MAG and pressing the + or – button at the same time. The door must be closed. The + button moves the ATC from station 1 to 2 to 3 etc. Make sure the ATC is rotating in the correct direction. If the 30/ 40 Tool ATC has been installed, check that stations 24-30 or 24-40 are recognized by the control.
<input type="checkbox"/>	36. Double check the tool change height by loading tools in and out of the ATC. Once verified, check to make sure that the tools load and unload properly into the ATC. When a tool is loaded into the spindle, make sure the spindle does not rotate when the arm releases the tool into the spindle. If you see movement, the spindle orientation angle may need to be adjusted. Use parameter 34090(0) to change the orientation angle and 30600(0) and 14514(0) to adjust the tool change height.
<input type="checkbox"/>	37. Select ATC test ini file called VMC ATC TEST PROGRAM TMZ.INI and press EXECUTE. Open program and run program called VMC ATC TEST PROGRAM.MPF to test the tool changer. The program will take approximately 15 minutes. Load 5 tools into the ATC before running this test.
<input type="checkbox"/>	39. Turn off air to the machine (in-line switch) and verify the control recognizes low air pressure. There should be a warning message on the screen.
<input type="checkbox"/>	39. Spindle head test: Run spindle at 1000 RPM for 10 minutes Run spindle at 8000 RPM for 10 minutes. Run spindle at 12000 RPM for 5 minutes. Run spindle at 500 RPM increments for a few seconds per increment. Please note any of the following: Head noise, excessive heat on spindle, vibration, spindle fan noise.
<input type="checkbox"/>	40. Run the test program called AXIS RAPID TEST (VMC7 or VMC10 or VMC12 or VMC14).MPF. This will run machine at maximum rapid speed. Confirm machine runs with no issues.
<input type="checkbox"/>	41. Assemble the tool measurement cart and tool measurement gage if this option was ordered. Make sure to align the tool measurement gage per the instructions included with the kit. Make sure to attach the SWI logo that comes in the hardware kit to the cart.
<input type="checkbox"/>	42. Confirm the MCP panel has the key plugged in to change the access level. Key is shipped in tool box.
<input type="checkbox"/>	43. Remove front door sill protective material.
<input type="checkbox"/>	44. Wipe down machine.

2.15 Tool Setter, Workpiece Probes and Required Optical Receiver

2.15.1 Mount OMI-2T Optical Receiver

The following details how to mount the OMI-2T Probe Receiver Assembly (P/N: 34080-10) on all VMCsi models. The receiver is essential and needs to be installed before either the Tool Setting or Workpiece Probes can be installed.

1. In order to install the OMI-2T Receiver Assy (P/N: 34080-10), tap M6 holes for cable routing on the following areas. Tap one (1) M6 hole on top of the bracket next to the door on the left from inside of the machine.

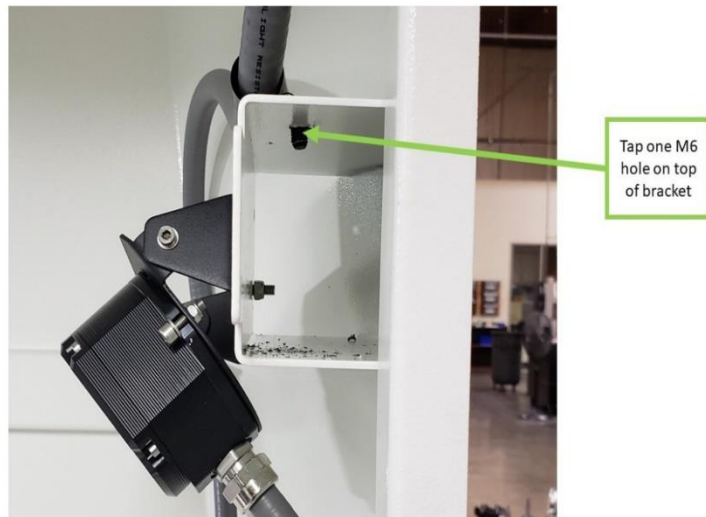

2. As shown on the image, tap three (3) M6 holes on the front of the same bracket above. The OMI-2T Receiver Assy will be installed here. Use the 3D Printed Jig (P/N: 34050-JIG) to locate the three (3) M6 holes to be tapped onto the bracket.

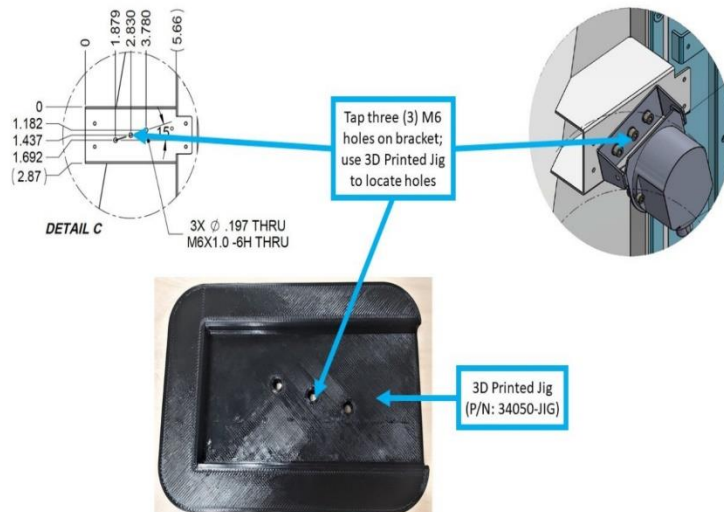

3. Tap three (3) M6 holes near the light above the left side door from inside the machine. Note: Future machines may get shipped with tapped holes.



4. Punch through hole on the back wall of the machine for cable routing (see image). Please note that for the VMC7si and VMC10si, these two holes are near the bracket on the top left corner of the back wall. For the VMC12si and VMC14si, these two holes are on the very top left corner of the back wall; no bracket will be present.

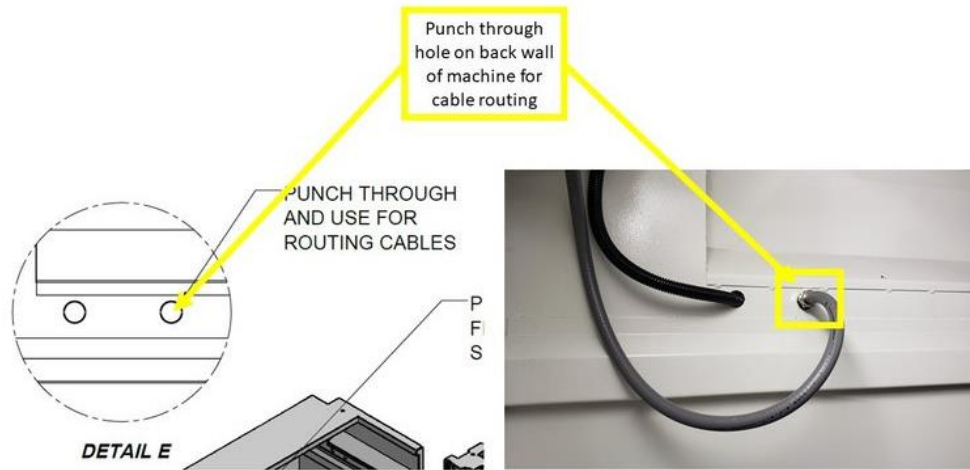

5. With the use of two (2) M5 screws, washers, and Nylon lock nuts (provided by Renishaw), fasten the OMI-2T Receiver Assy to the Receiver Bracket (P/N: 34080-4). Apply a torque of 3.68 lbf-ft.

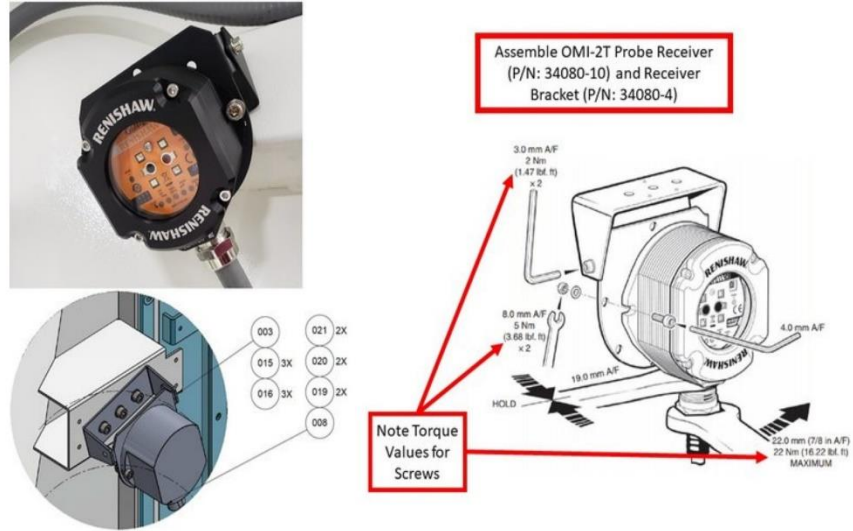

6. With the use of three (3) M6 screws and washers, install the OMI-2T Probe Receiver Assy and Receiver Bracket to the bracket inside the machine with three (3) M6 tapped holes. Tilt the OMI-2T Probe Receiver downwards toward the base of the spindle on the machine. Note: Receiver must be orientated as shown on the image to prevent coolant ingress through cores into the OMI-2T.

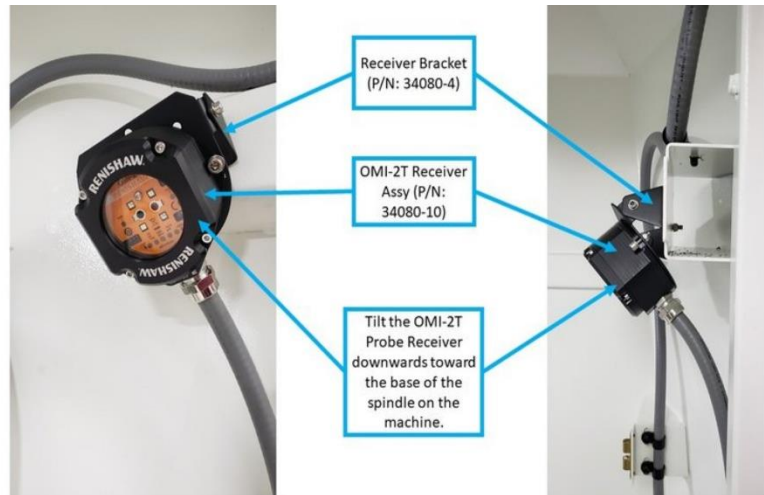

7. Refer to the image for the cable routing and set up for the loop clamps, screws, and washers for the OMI-2T Probe Receiver.

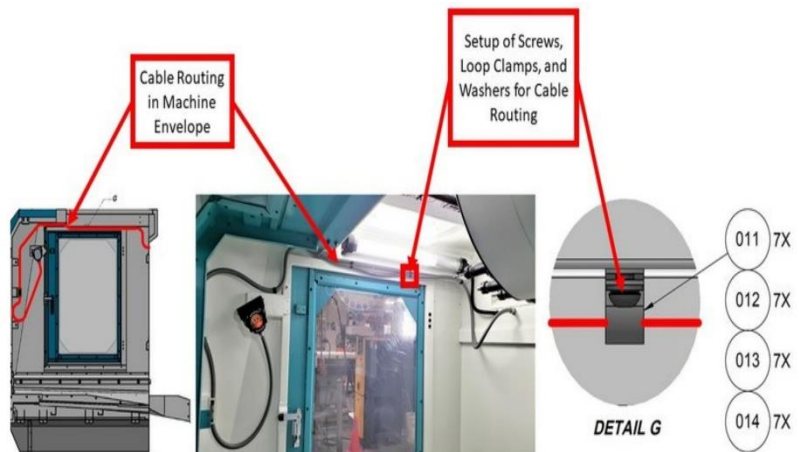

8. Before proceeding with the next steps, remove the Female Terminal Block Connector (P/N: 50776-4) from the cable end of the OMI-2T Probe Receiver, and carefully tape the wires together in order to allow the cable itself to pass through the hole knockout area and the machine's cable troughs.

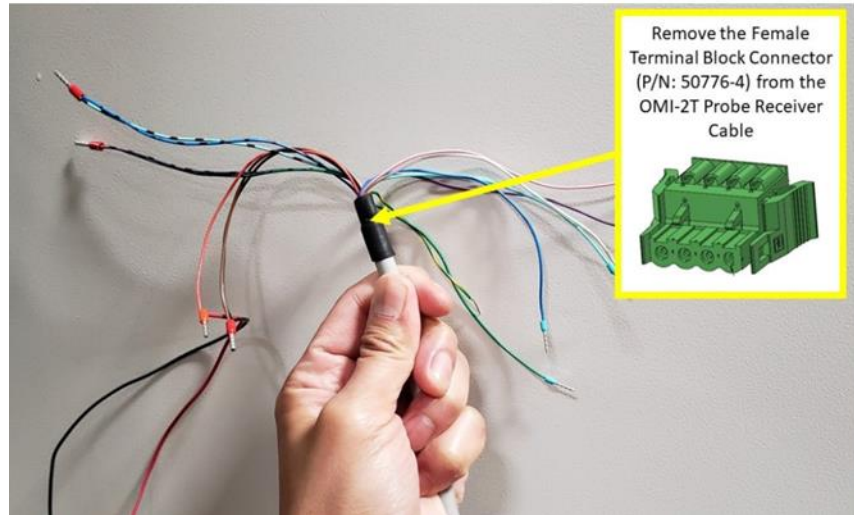

9. Once the OMI-2T Probe Receiver is installed on the bracket near the left side door, direct the cable to the front door latch from inside the machine. Remove the two existing screws from the front door latch, and install two loop clamps to bind the cable to the door latch. Secure the two screws back onto the door latch once complete. Next, direct the cable from the door latch, back to the top of the bracket where the OMI-2T Probe Receiver is installed. Use one (1) M6-1.0X10 (27B) screw and washer, and one (1) loop clamp to bind the cable to the top of the bracket. From the top of the bracket, direct the cable to the three (3) M6 tapped holes near the light above the left side door. Use three (3) M6-1.0X10 (27B) screws and washers, and three (3) loop clamps to bind the cable. Finally, direct the cable through the hole knockout area on the interior back wall of the machine. Install the fitting with seal (P/N: 34080-6) with the cable when directing the cable through the hole.

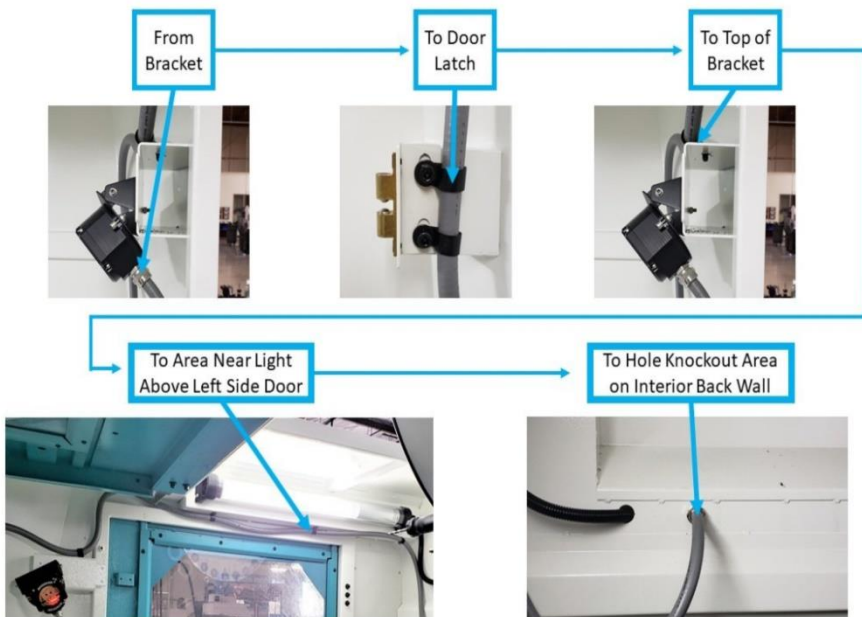

10. From the hole knockout area, zip tie Receiver Cable to existing cables that are heading toward the cable troughs. Direct the OMI-2T Probe Receiver Cable through the cable troughs from the back of the machine to the PPU. Please refer to the image for the cable routing involved; it shows the general path that the OMI-2T Probe Receiver Cable should take. Note: When routing the cable, it should follow the other cables inside the enclosed cable troughs to the PPU.

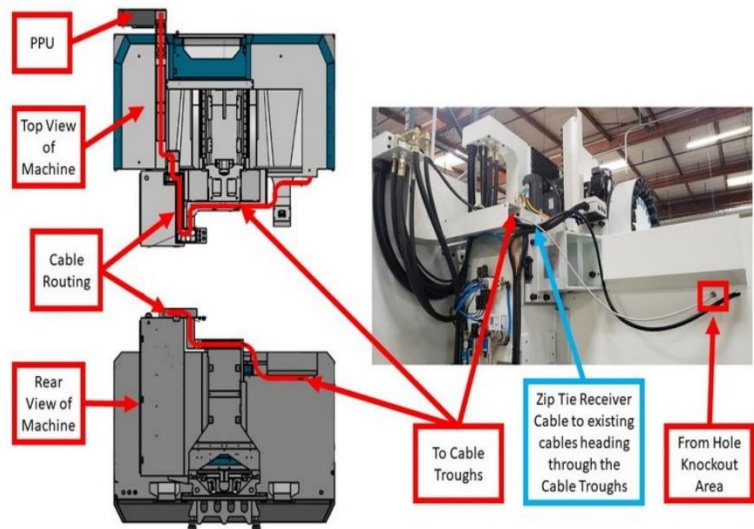

11. As shown on the image, remove the tape on the OMI-2T Probe Receiver Cable's colored wires and reconnect them back with the cable's Female Terminal Block Connector (P/N: 50776-4) that was removed earlier. Install the combined

Turquoise/Black and Blue/Black Wires to Position 1 (P1.1) of the Terminal Block Connector. Install the combined Violet/Black and Green/Black Wires to Position 2 (P1.2). Install the combined Red and Red Jumper Wires (P/N: 22285-RD-22G) to Position 3 (P1.3). Install the combined Black, Brown, and Black Jumper Wires (P/N: 22285-BK-22G) to Position 4 (P1.4).

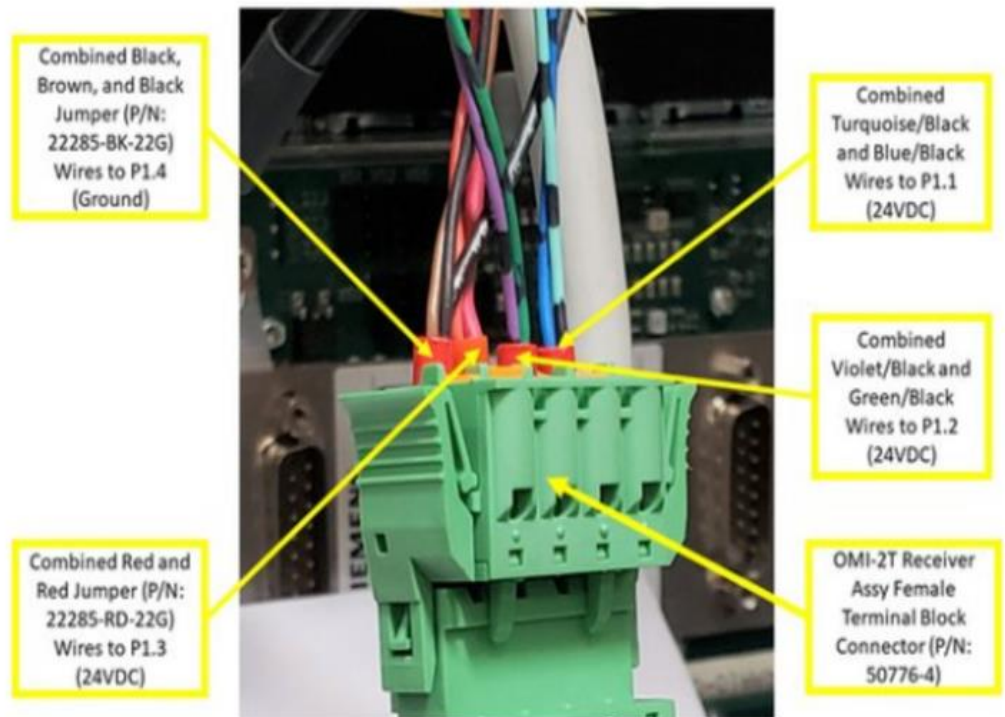

12. Connect the Probe Receiver 24VDC Power Cable (P/N: 31594-2) from the electrical cabinet, through the cable troughs, and into the PPU. Please see first image with the green line for the cable routing.

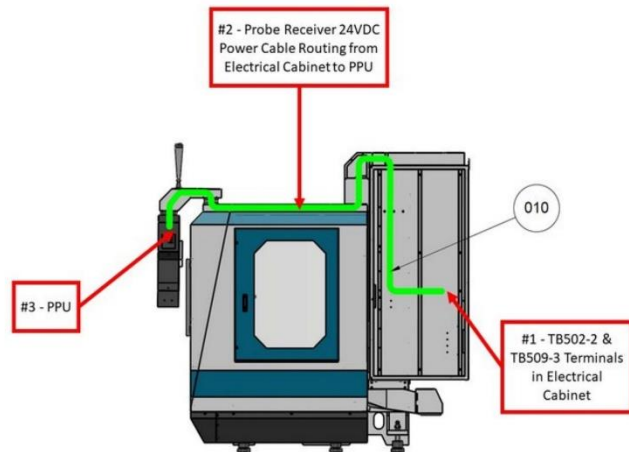

13. Install the Red Wire (24VDC) of the Probe Receiver Power Cable to TB502-2 (as shown on the image). Install the Black Wire (Ground) to TB509-3

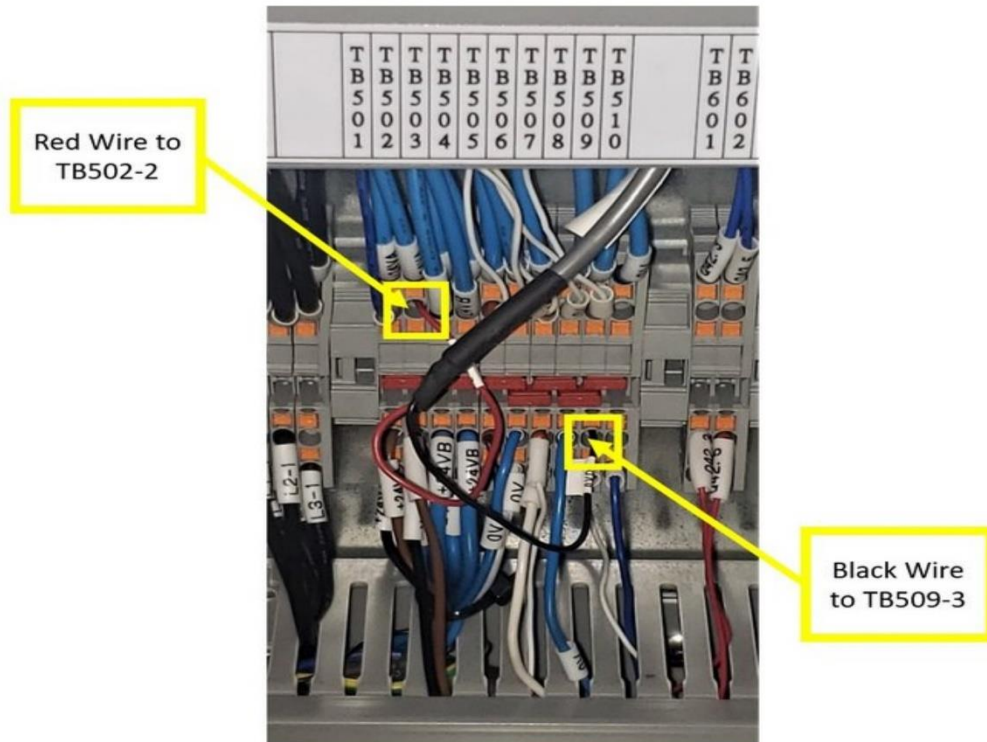

14. From the TB502 and TB509 terminals, direct the Probe Receiver 24VDC Power Cable through the left wire way and into the cable troughs.

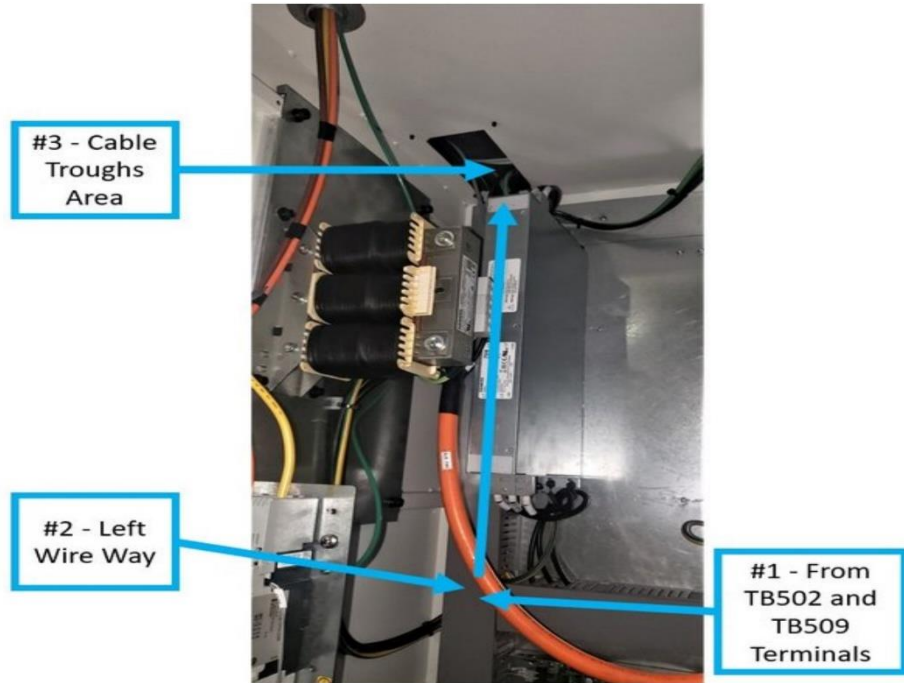

15. Coming from the cable troughs, connect the Probe Receiver 24VDC Power Cable to the OMI-2T Receiver Assy Cable.

Note: Neatly coil both cables in the Pendant Housing.

For the next section, the OMI-2T Receiver Assy Cable also must be connected to both the Probe Receiver 24VDC Power Cable and the PPU.

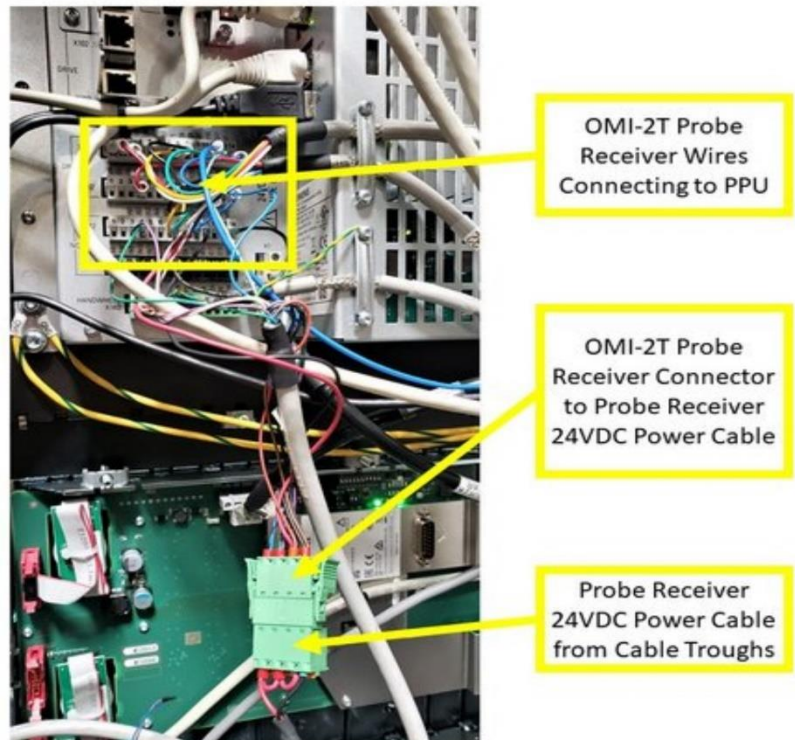

16. Wiring Interconnections Chart involved for connecting the OMI-2T Probe Receiver Cable to the PPU and the Probe Receiver 24VDC Power Cable.

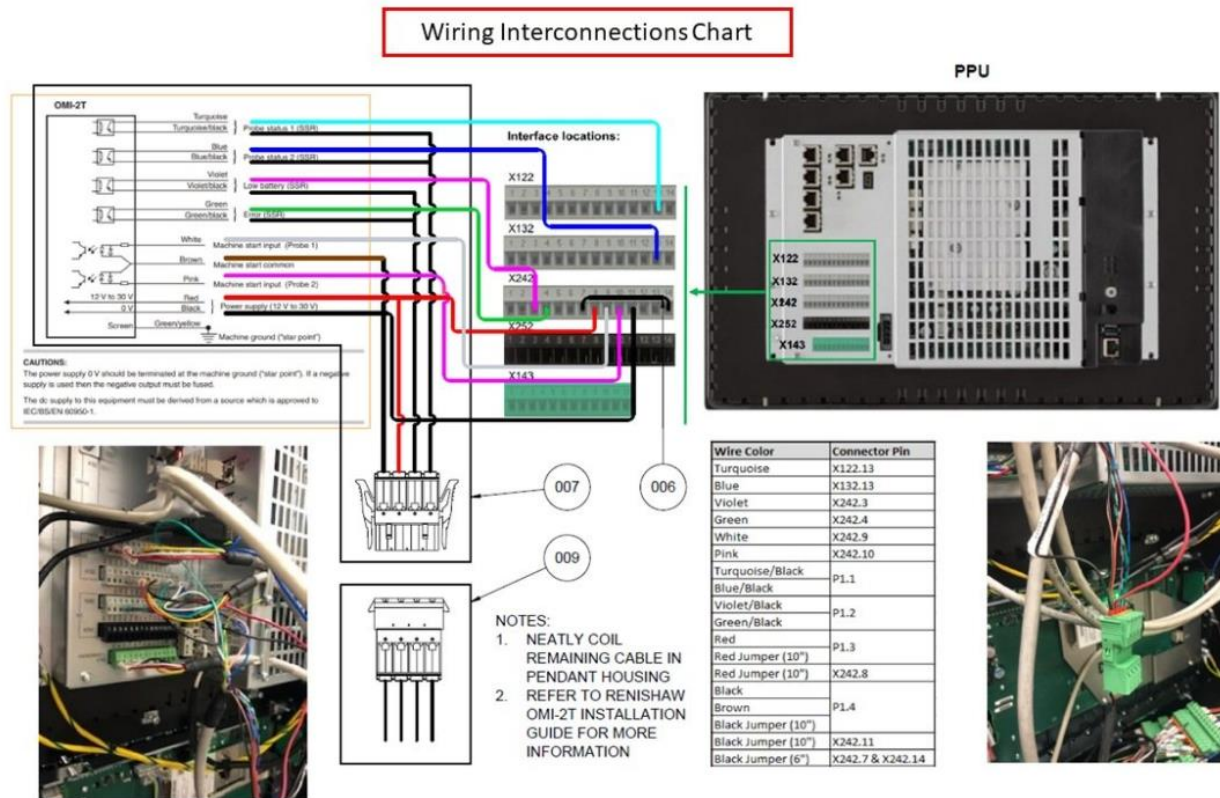

17. The designations for each PPU Interface Terminal Block locations. X122, X132, X242, and X252 have 14 terminals. X143 has 12 terminals.

Note: Each Interface Terminal Block can be removed and replaced back into the PPU in order to assist with the wiring process.

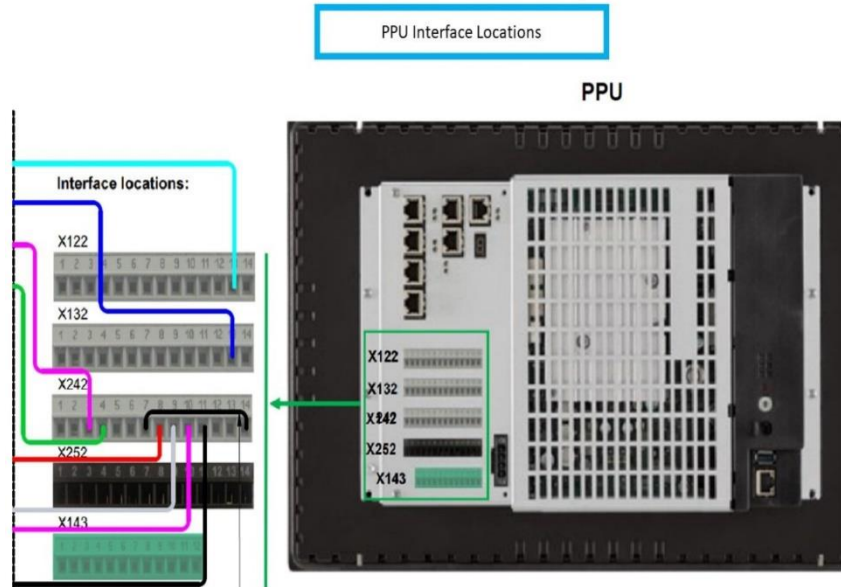

18. On the X122 Terminal Block, install the Turquoise Wire of the OMI-2T Receiver Cable to X122.13. On the X132 Terminal Block, install the Blue Wire to X132.13.

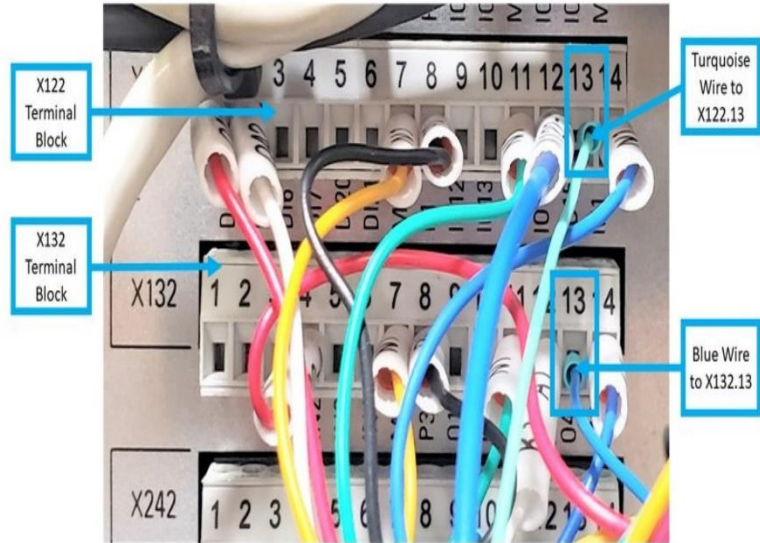

19. On the X242 Terminal Block, install the Probe Jumper Wire (P/N: 34080-9) from X242.7 to X242.14.

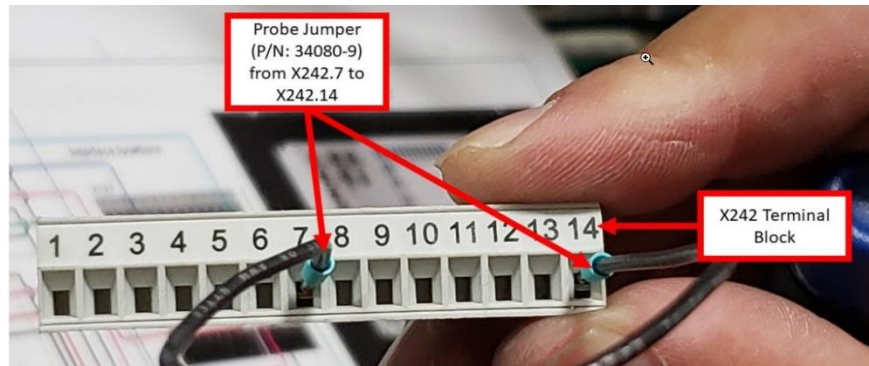

20. On the X242 Terminal Block, install the Violet Wire to X242.3, the Green Wire to X242.4, the White Wire to X242.9, and the Pink Wire to X242.10. Install the other end of the Red Jumper Wire (P/N: 22285-RD-22G) from Position 3 of the OMI-2T Receiver Assy Female Terminal Block Connector to X242.8. Install the other end of the Black Jumper Wire (P/N: 22285-BK-22G) from Position 4 of the OMI-2T Receiver Assy Female Terminal Block Connector to X242.11.

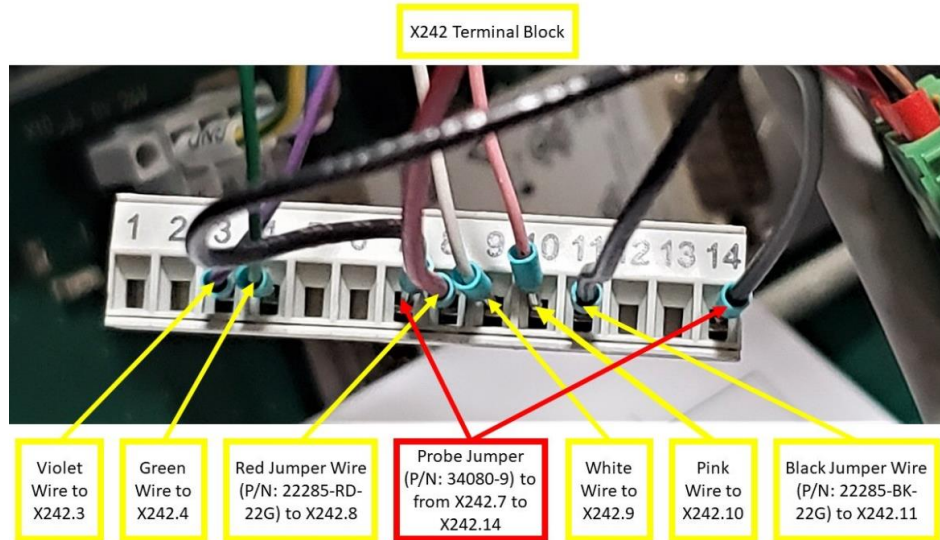

21. Install the Green/Yellow Wire at the machine ground ("star point"), as shown on the image.

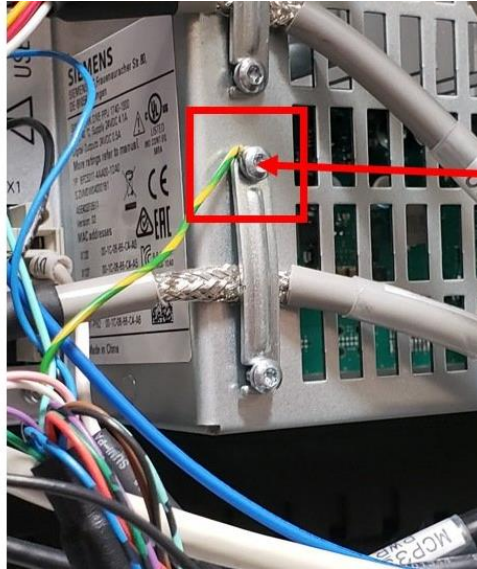

Green/Yellow Wire to Machine Ground ("Star Point")

2.15.2 Setup and Calibration of The Optical Tool Setting Probe Option

The following guide details how to install and calibrate the OTS Probe (P/N: 34080-2) on all VMCsi models.

1. Insert the Break Stem through the Captive Link, and install them to the OTS, as shown on the first image on the left. Use a 5mm flat Allen wrench to secure the Break Stem to the OTS. Do not overtighten; make sure it is snug (torque to 1.84 - 1.99 lbf-ft). Bend Captive Link upwards after Break Stem is installed to the OTS. Insert the Stylus on top of the Coupler, and then secure the top set screw (labeled as Set Screw #1, which is designated for the Stylus) to the Coupler with a 2mm Allen wrench. Do not overtighten the set screw; make sure that it is snug (torque to 0.74 - 0.89 lbf-ft).

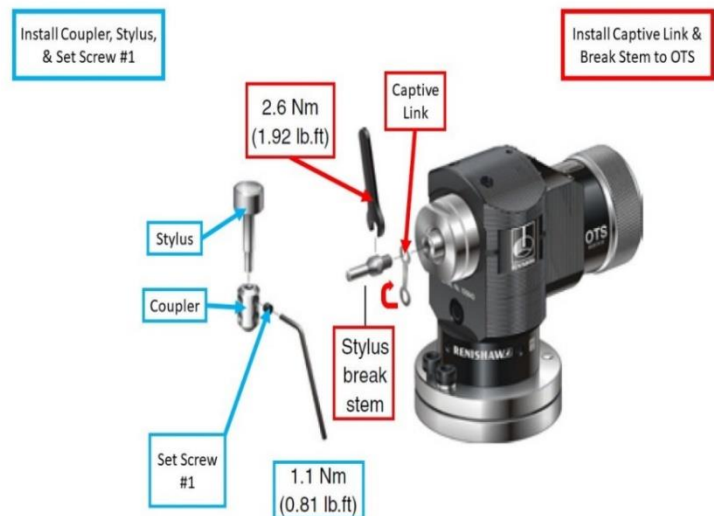

2. Using both the Support Bar and a 3 mm Allen wrench, insert the Cap Screw through the bent Captive Link, and secure it at the bottom of the Coupler. Do not overtighten, make sure it is snug (torque to 1.84 -1.99 lbf-ft). Next, secure the bottom set screw (labeled as Set Screw #2, which is designated for the Cap Screw) to the Coupler by using both the Support Bar and a 2 mm Allen wrench. Do not overtighten, make sure it is snug (torque to 0.74 - 0.89 lbf-ft). Note: Always hold the Support Bar in position to counteract twisting forces, and avoid over-stressing the Break Stem.

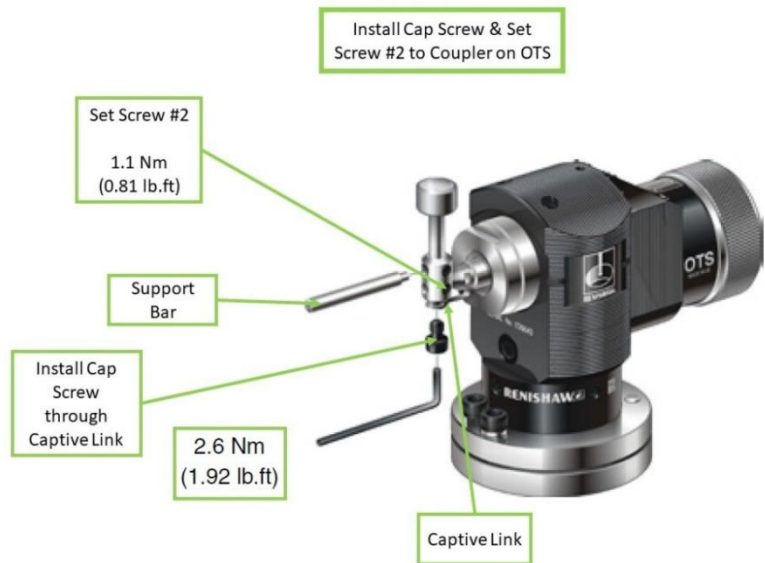

3. Separate the OTS Body and Base by using a 2.5 mm Allen Wrench and loosening the four (4) screws marked as "1". Next, loosen the two (2) screws marked as "2". Fit the M12 bolt and T-Slot Nut to the OTS Base, and tighten to secure the Base to the machine table.

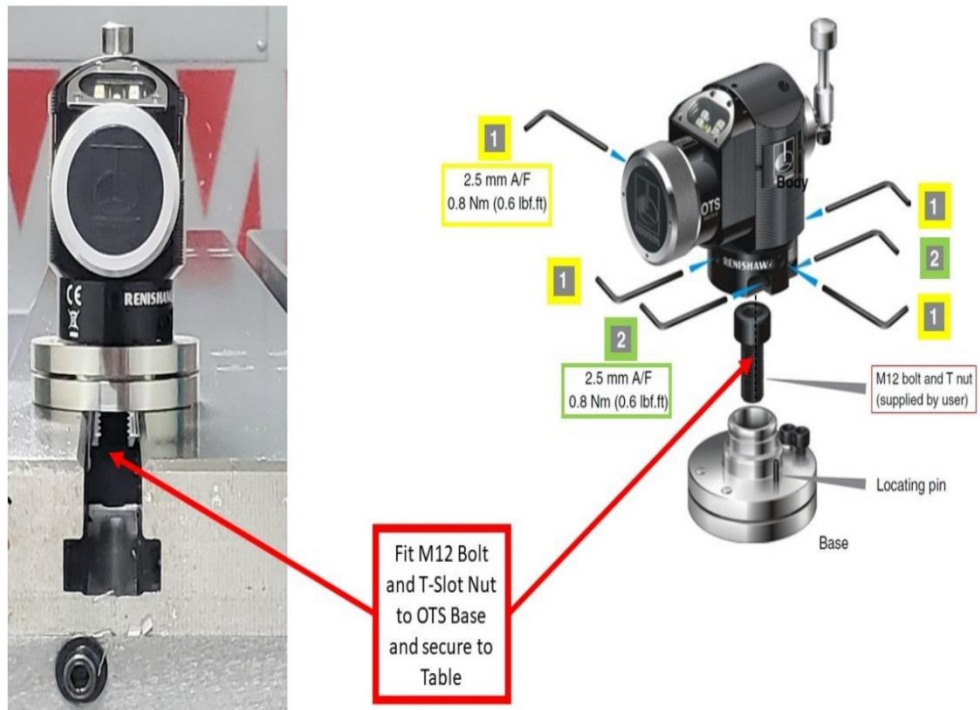

4. Place the OTS on the furthest T-Slot on the machine table where it will avoid collision from any direction. It should be approximately 2" away from the edge of the machine table.

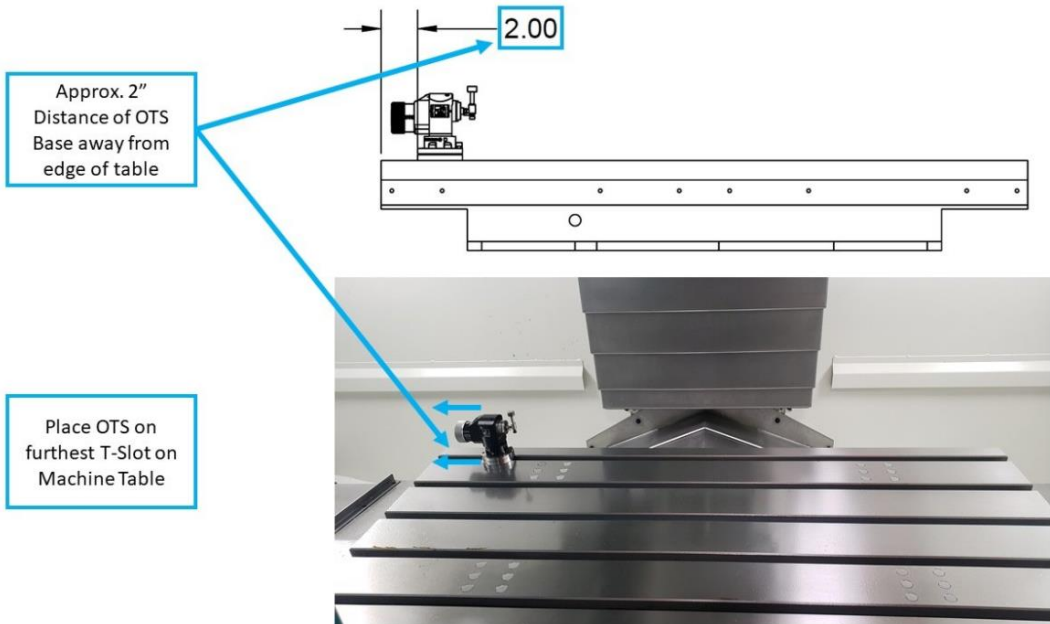

5. Make sure that the Optical Window of the OTS is facing towards the OMI-2T Probe Receiver.

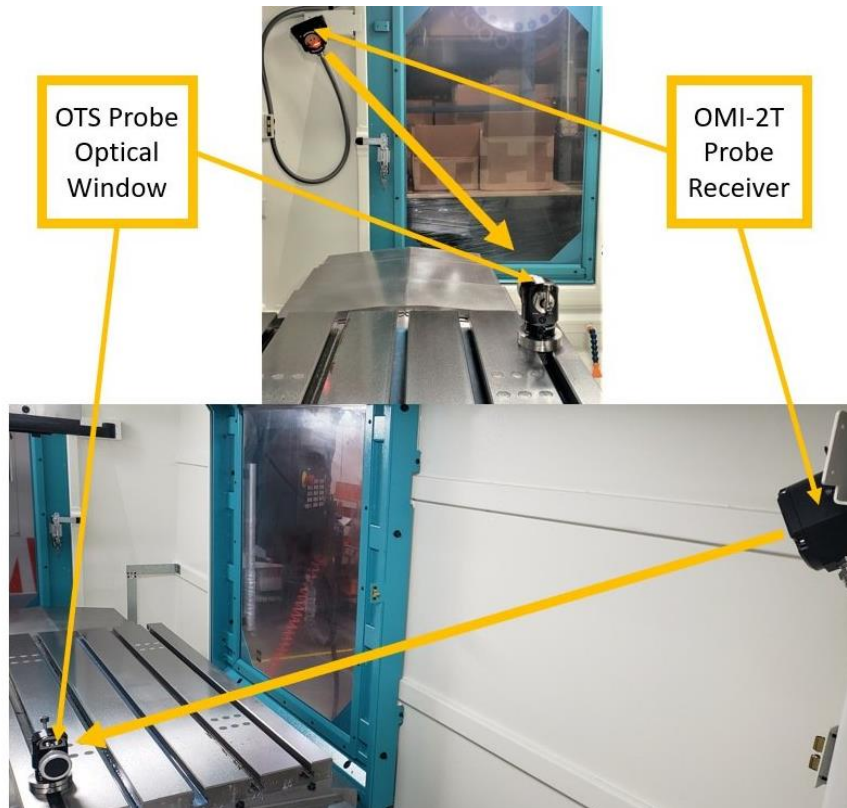

6. Refit the OTS Body back into the Base by securing the four (4) screws labeled as "1." Do not overtighten; make sure it is snug (torque to 0.6 lbf-ft). Secure the two (2) screws labeled as "2." Do not overtighten; make sure it is snug (torque to 0.6 lbf-ft).

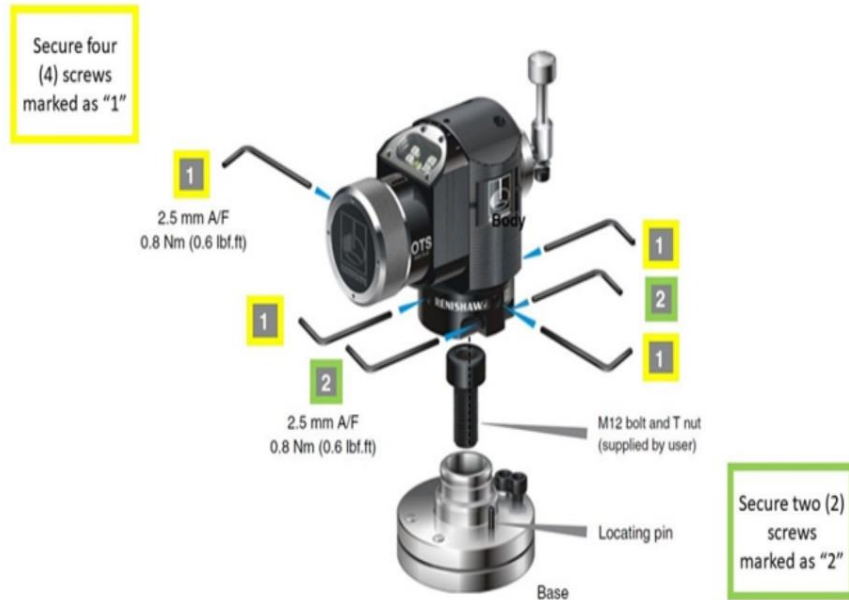

7. The Optical Module of the OTS can be set in one of seven (7) positions at 15° increments in order to allow the OTS Optical Window to point towards the Probe Receiver. As shown on the image, jog the table until the OTS is directly under the spindle. This position is where the tools will be touched off on, so it needs to be in the line of sight where the Probe Receiver is pointing.

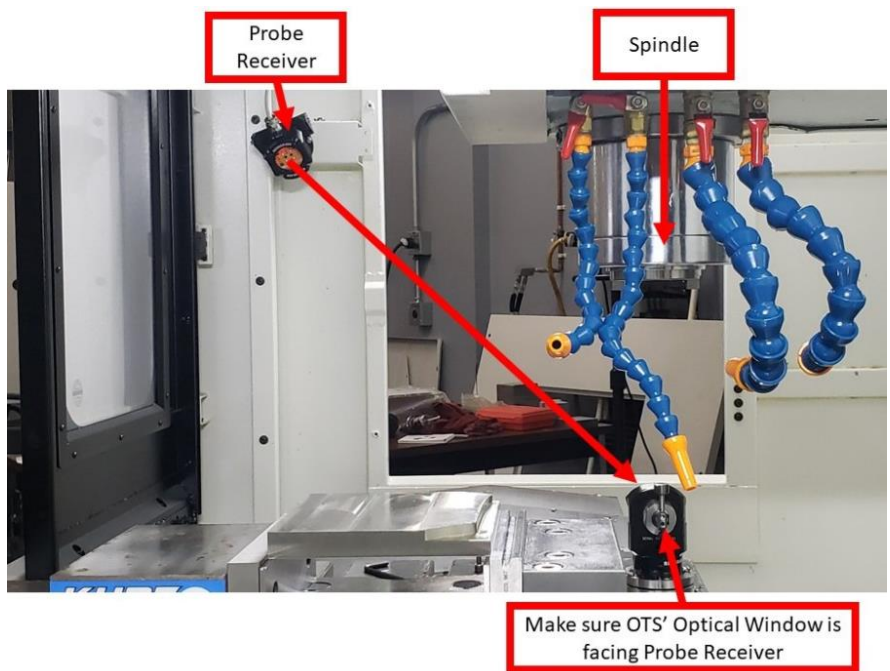

8. In order to be able to align and rotate the Optical Module, first slacken and partially pull out the Clamp Screw by using a 4mm flat Allen Wrench.

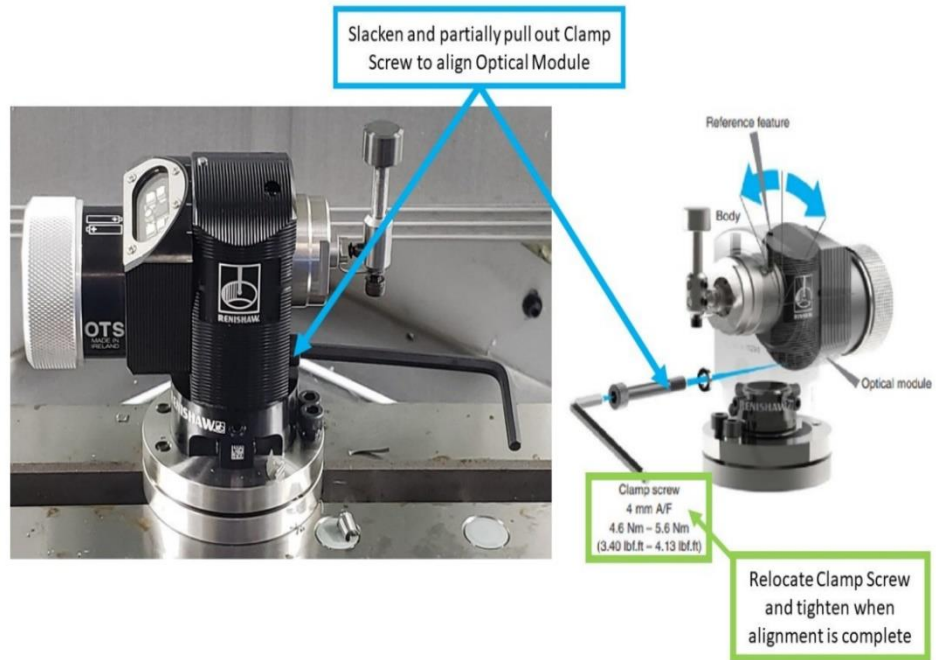

9. As shown on the image, rotate the Optical Module of the OTS by lining up a 15° Reference Mark on the Optical Housing with the Reference Feature on top of the Body. Keep rotating the Optical Module until the Optical Window of the OTS points directly toward the Probe Receiver. Once alignment is complete, relocate the Clamp Screw back into the OTS, and tighten (torque to 3.7 lbf-ft).

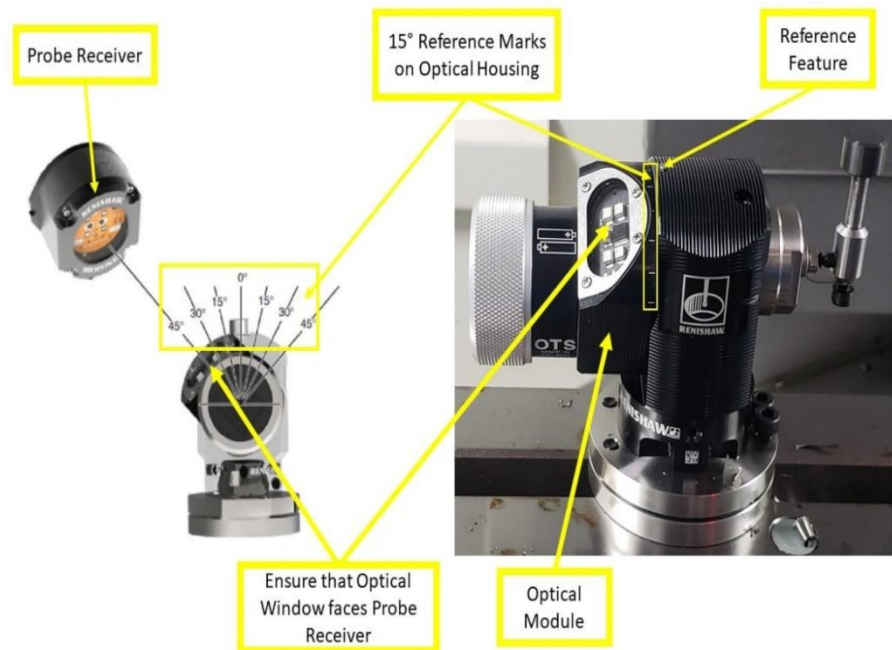

10. The following procedures detail how to set up and calibrate the Probe Tool Option within the Siemens control of the VMCSi. Select JOG on the Machine Control Panel (MCP).



11. The top surface of the OTS Stylus must be set level from front to back on the X Axis, and side to side on the Y Axis. Set up a .0001" dial indicator on the spindle, as shown in the picture. Rotate the face of the indicator until the "0" marking aligns with the dial. The dial should face forward, and the indicator itself points downwards toward the table. Jog the head with the attached dial indicator toward the top surface of the Stylus of the OTS. Touch off the indicator on the surface of the OTS Stylus, and then zero the indicator.

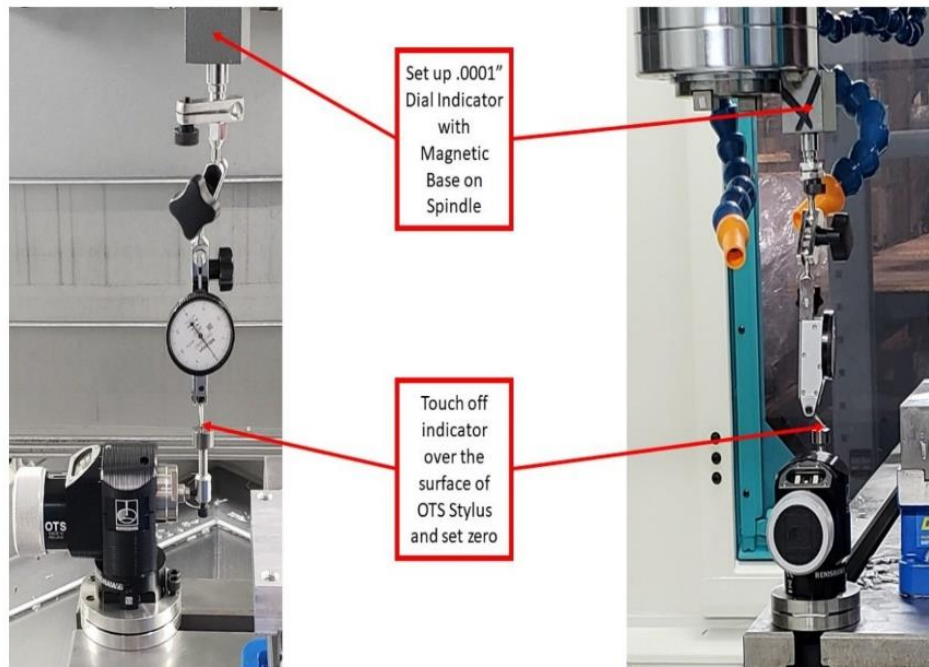

12. Sweep the dial indicator over the surface of the Stylus on the X Axis. The maximum tolerance for misalignment over the X Axis is +/- 0.0001".

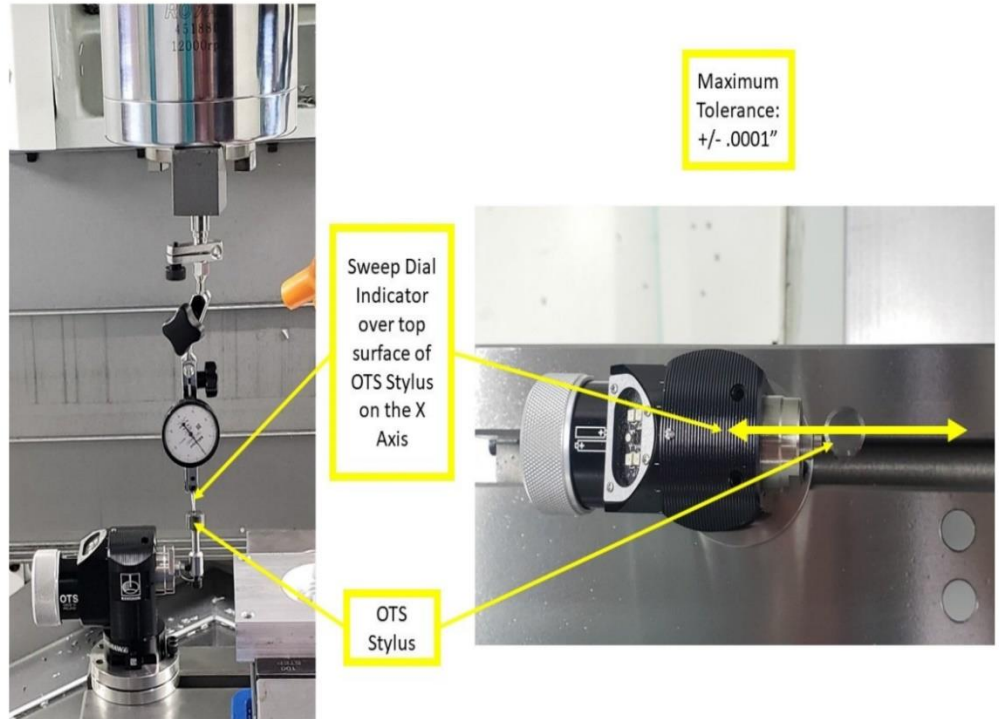

13. The following are front-to-back level adjustment procedures to raise and/or lower the front of the OTS. To raise the front of the OTS, use a 4 mm Allen Wrench to slacken Screw #2, adjust Screw #1 until Stylus is level, and then finally tighten Screw #2 (torque to 3.40 - 4.13 lbf-ft). To lower the front of the OTS, use a 4 mm Allen Wrench to slacken Screw #1, adjust Screw #2 until Stylus is level, and then finally tighten Screw #2 (torque to 3.40 - 4.13 lbf-ft). In case that the Stylus and/or Coupler parts need to be adjusted for height, refer to that step.

- Raise the Front
- Slacken Screw #2
 - Adjust Screw #1 until Stylus is level
 - Tighten Screw #2 (Torque to 3.40 – 4.13 lbf-ft.)

- Lower the Front
- Slacken Screw #1
 - Adjust Screw #2 until Stylus is level
 - Fully tighten Screw #2 (Torque to 3.40 – 4.13 lbf-ft.)



14. Keep adjusting the height until the maximum tolerance $\pm 0.0001''$ is met, and the X Axis is properly leveled. Once the X Axis has been properly leveled, sweep the dial indicator over the surface of the Stylus on the Y Axis. Similar to the X Axis, the maximum tolerance for misalignment is $\pm 0.0001''$.

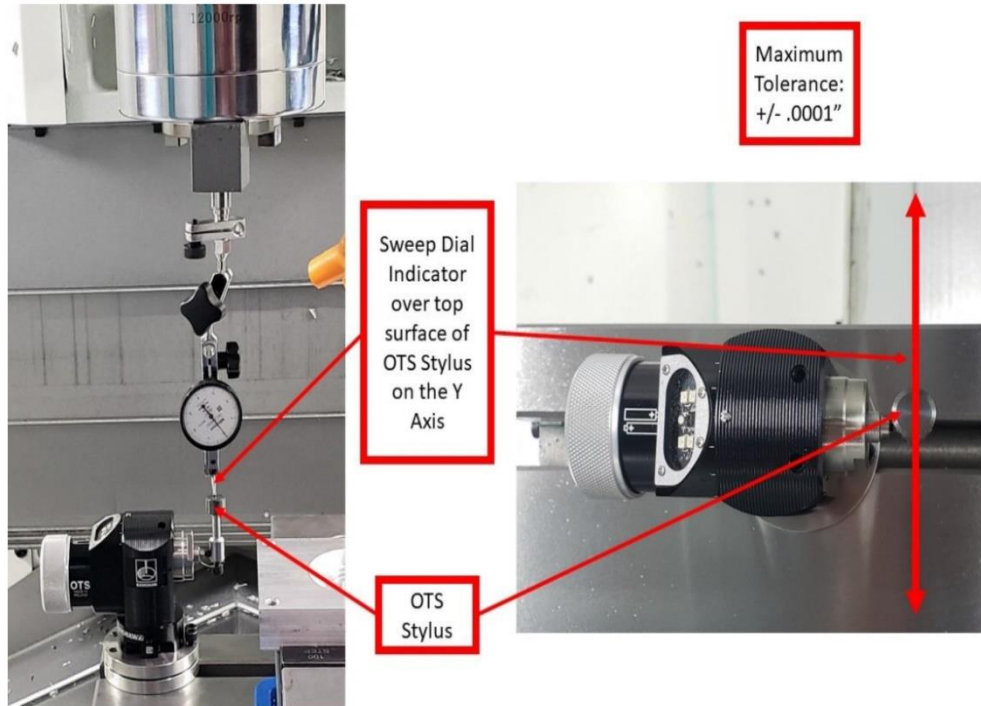

15. Adjust the two (2) set screws (as shown on the image) in order to achieve side-to-side level adjustment. Adjusting these set screws causes the OTS to rotate, and change the Stylus level setting. Adjusting the right set screw causes the OTS to tilt slightly to the right, and adjusting the left set screw causes the OTS to tilt slightly to the left. Adjust these set screws until the OTS Stylus is leveled. Once a level stylus surface and/or the maximum tolerance of $\pm 0.0001''$ are obtained, tighten the two set screws to 0.52 - 0.66 lbf-ft.

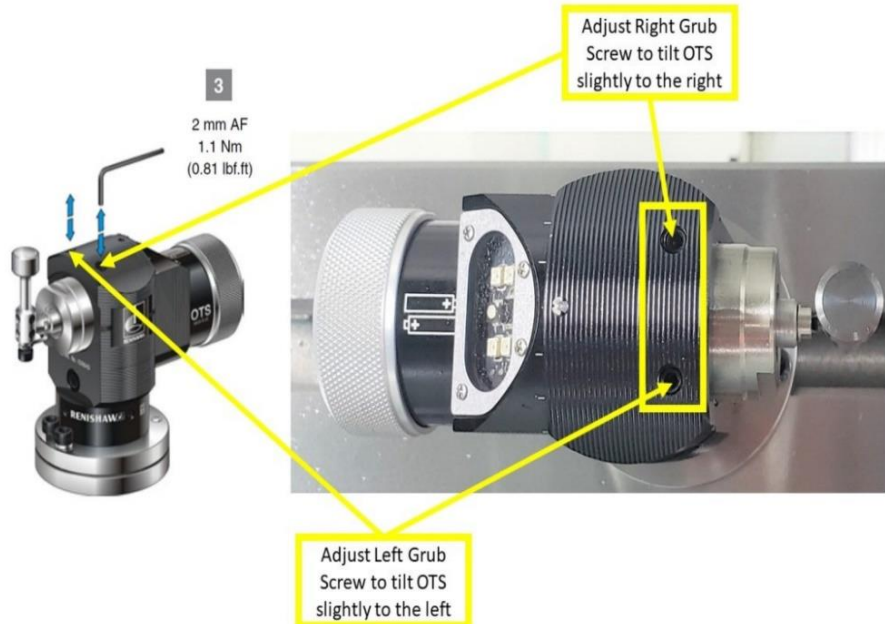

16. On the touchscreen, (1) press the first left-side bar shortcut key (the large "M," which is the Machine Key) on the top left of the screen.

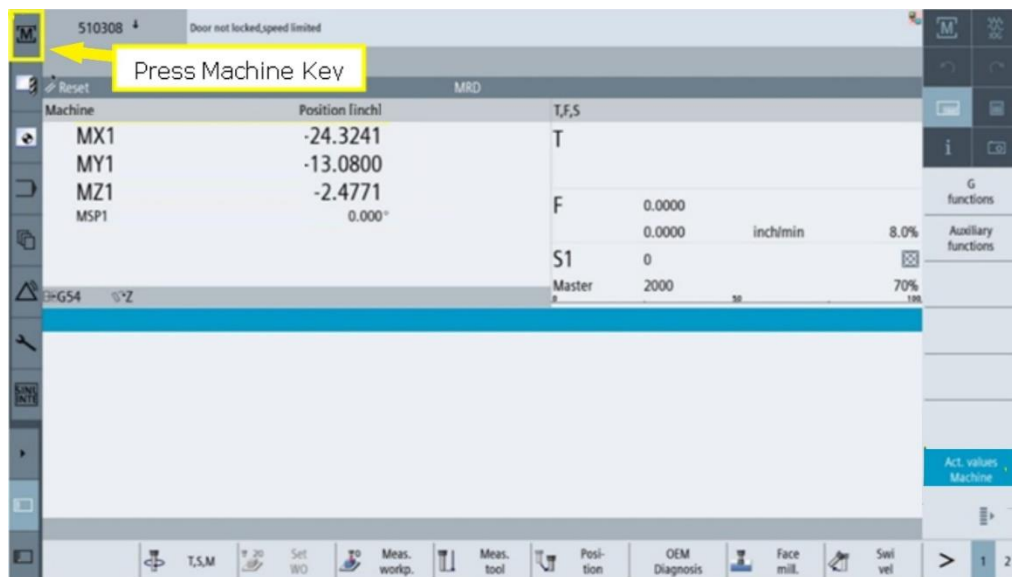

17. Next, manually set up the calibration tool. Press the second left-side bar shortcut key (Tool List), and select a location that is outside of the ATC tool list (not in locations #1 to 24). Next, press the VSK "New tool" on the right side of the screen.

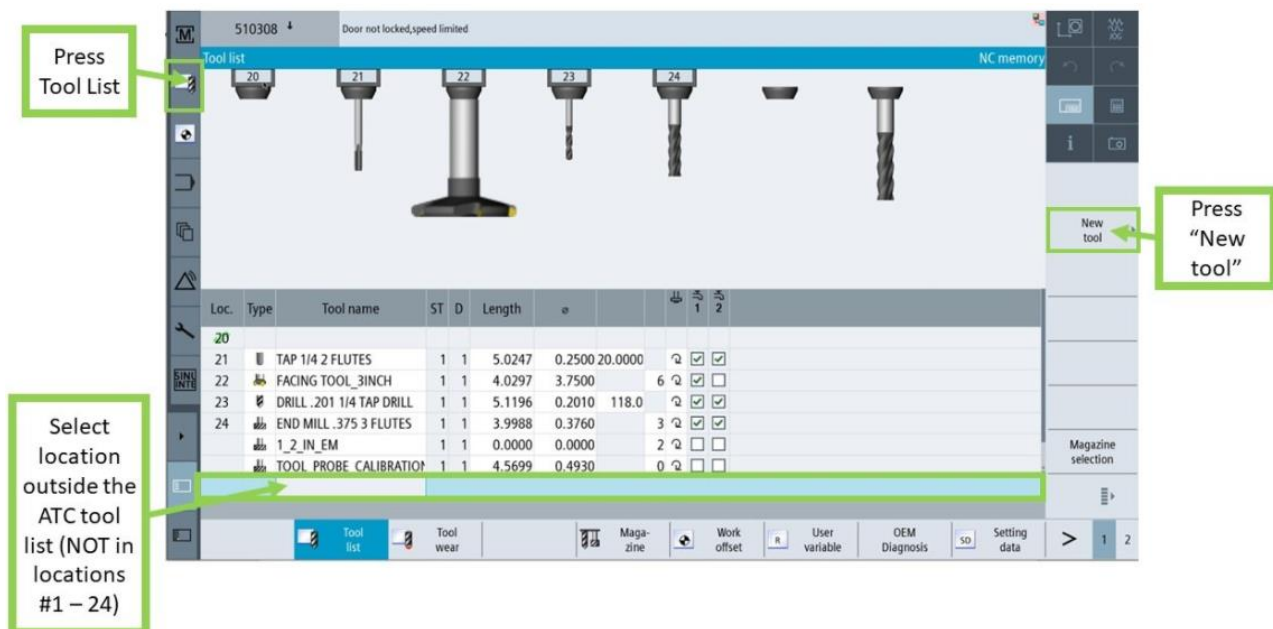

18. The "New tool - favorites" window will appear; select the VSK "Spec. tool 700-900" on the right, then choose "725 - Calibrating tool" as the new tool type. Press VSK "OK".

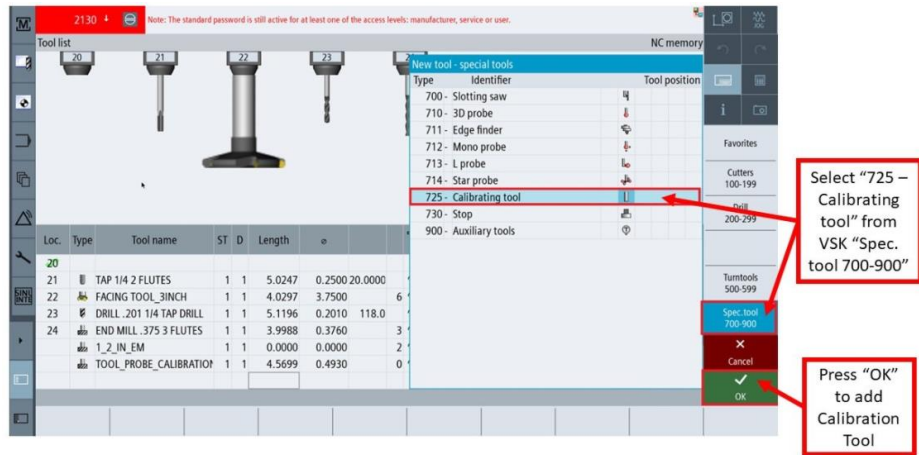

19. Once the calibration tool has been added to the tool list, enter the length and diameter for the calibration tool using pop-up keypad. Inset photo shows measurement data found engraved on calibration tool.

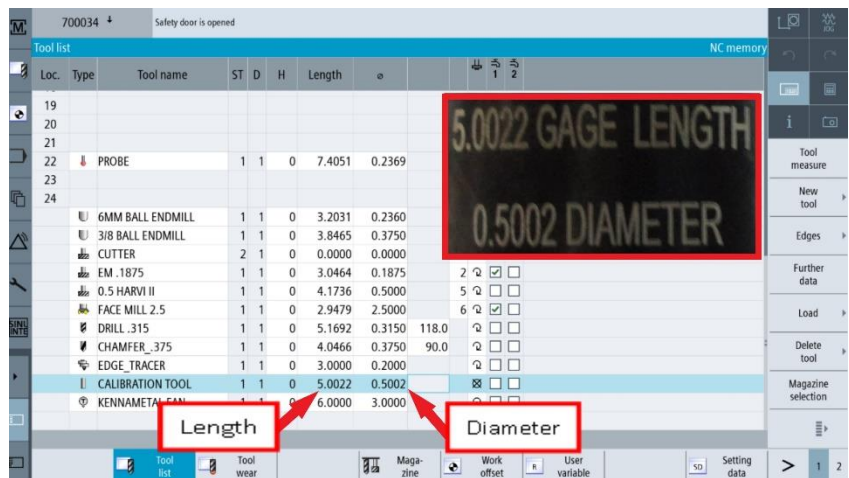

20. Manually load the Calibration Tool into the spindle through the following, Press Jog button on MCP at upper left corner, press (1) HSK "T,S,M," and then click on the (2) VSK "Select Tool".

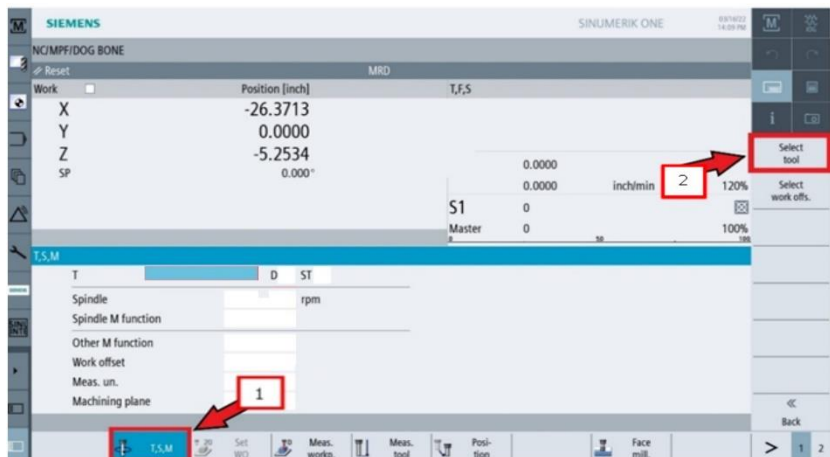

21. From the "Tool selection" window, click and choose the Calibration Tool, and hit VSK "OK".

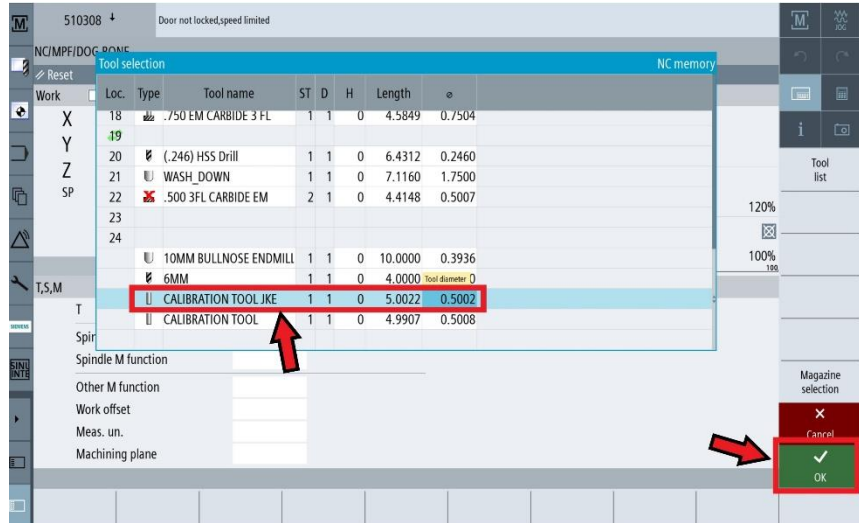

22. Press "Cycle Start" on the MCP. You will receive a prompt to load the Calibration Tool into the spindle.

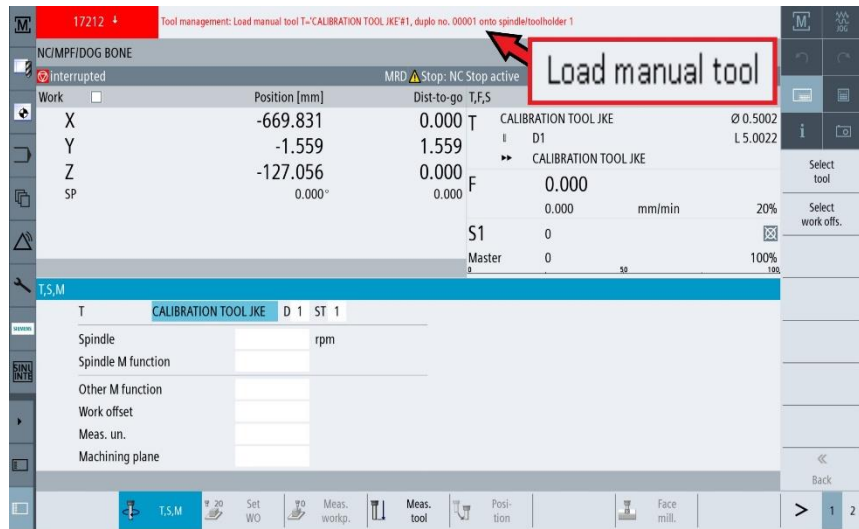

23. Press DOOR OPEN to unlock and open the machine door. Manually load calibration tool into spindle, close the door. Press cycle start to complete tool change procedure.

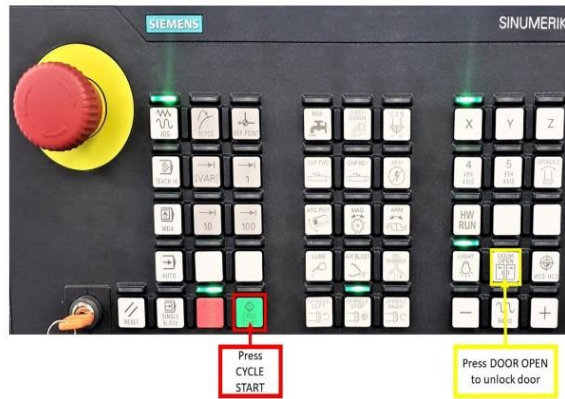

24. In order to calibrate the location of the OTS Probe, line up the Calibration Tool approximately 0.5" above the OTS Stylus. It should also be roughly centered on the X and Y Axes.

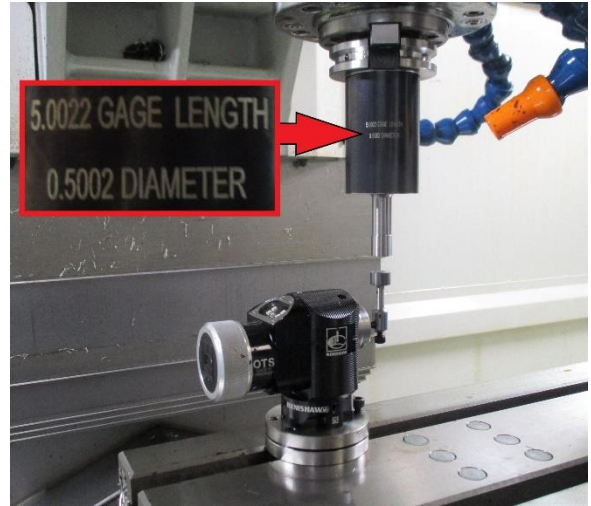

25. Press "Meas. Tool" HSK. Press the VSK "Calibrate probe".

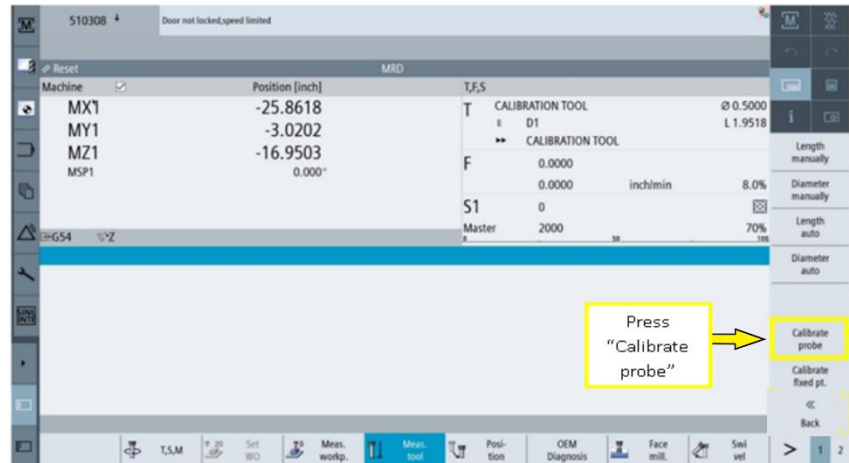

26. Once the "Calibrate probe" window appears, hit CYCLE START from the keyboard to begin calibration. After CYCLE START, the Calibration Tool will touch the top and sides of the OTS Stylus.

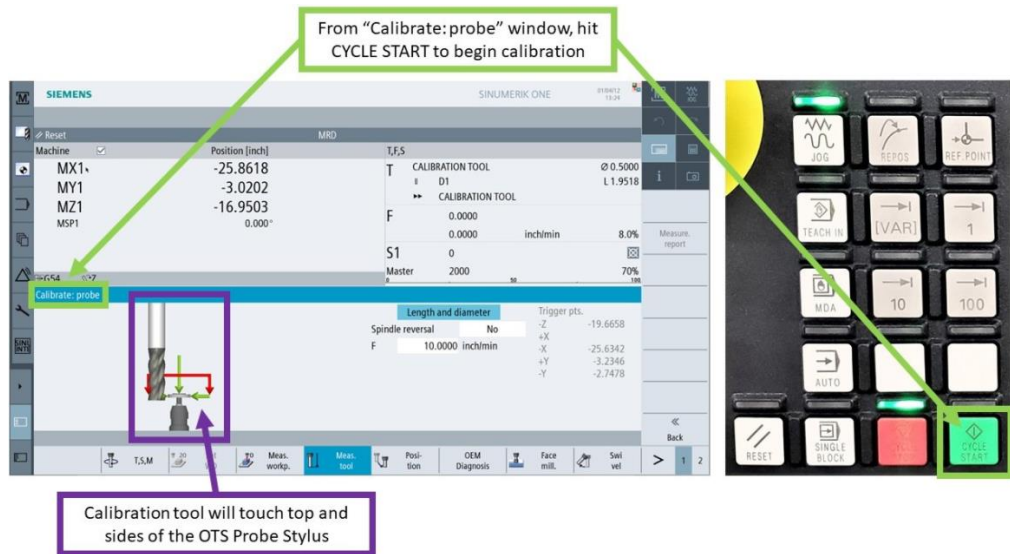

27. Once calibration ends, the "Calibrate: probe" window will show the final Machine Values and Trigger Points. In accordance to the Inspection process for the OTS Probe, conduct the Step 24 calibration process above three (3) times in a row, and take note of the Machine Values and Trigger Points each time. Ensure that these values remain consistent throughout this process.

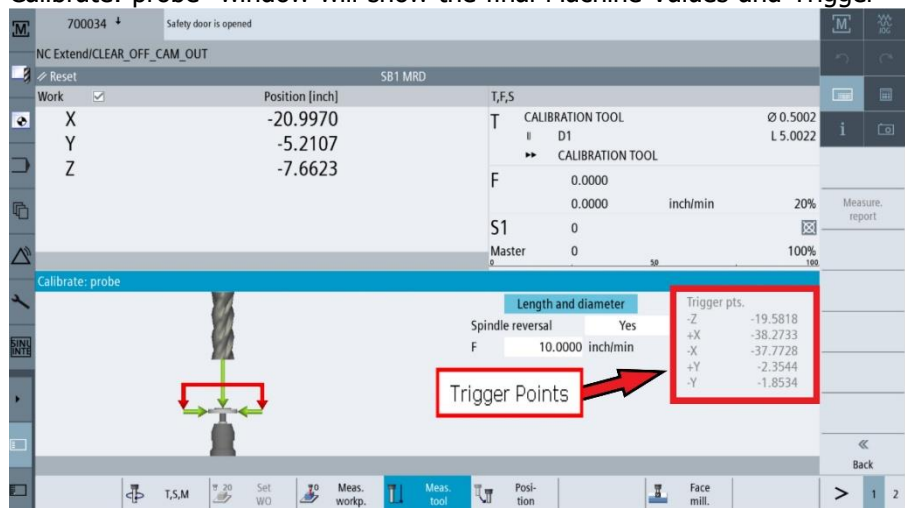

28. Press "Back" on the right VSK. Press "Length auto".

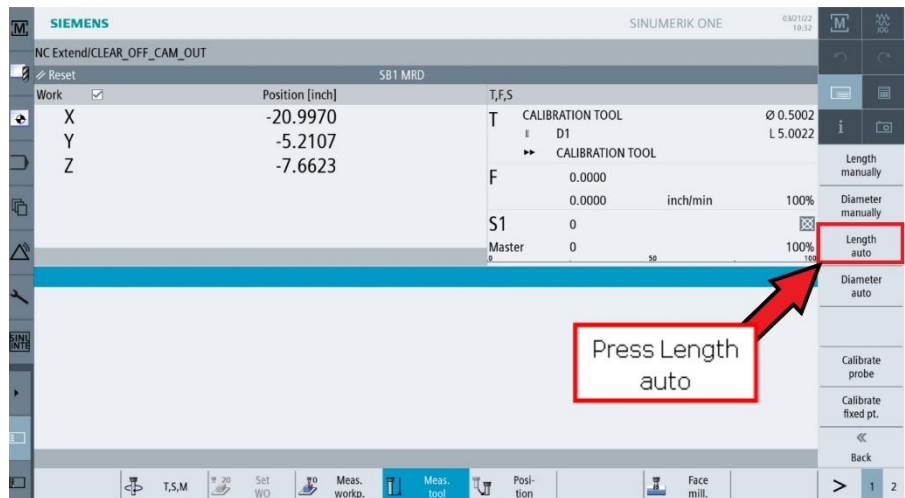

29. Press CYCLE START on the MCP. The machine will automatically position the calibration tool above probe stylus and measure the length of the tool.



30. Press "Back" on the right VSK. Press "Diameter auto"

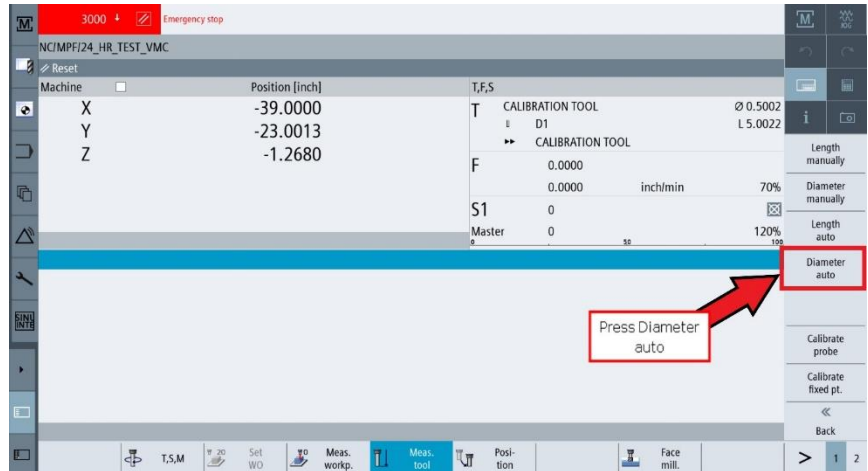

31. Press CYCLE START on the MCP. The machine will automatically position the calibration tool above probe stylus and measure the diameter of the tool.

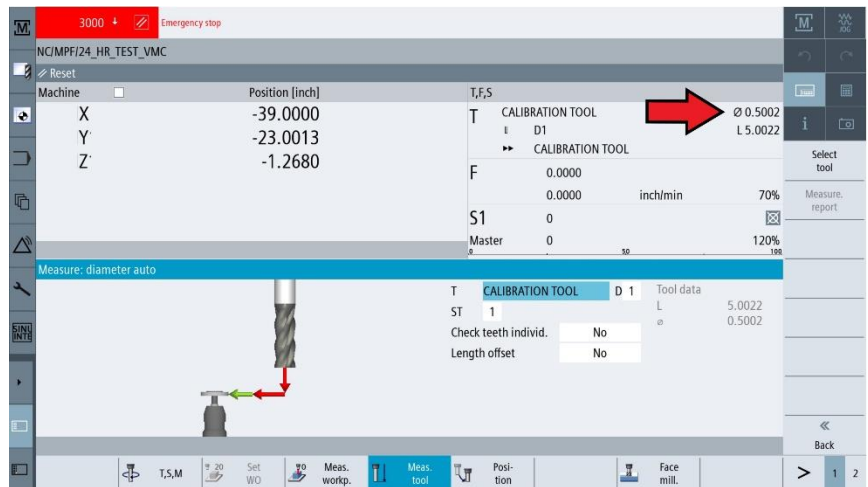

2.15.3 Setup and Calibration of The Optical Workpiece Probe Option

The following procedure details how to set up and calibrate the Probe Tool Option using the Siemens controller on the VMCsi Part number 34080-1. Speeds up the process of setting part zeros and work offsets. Can also be used to check accuracy of created parts and tooling providing corrections.

Warning: Only use the provided tool to tighten the Stylus into the OMP40-2 Probe. This tool is designed to bend at a torque below that which will damage the Probe.

1. Using the tool provided by Renishaw, tighten the Stylus (P/N: 34080-5) into the OMP40-2 Probe (P/N: 34080-1). Torque to 1.3 - 1.6 lbf-ft.

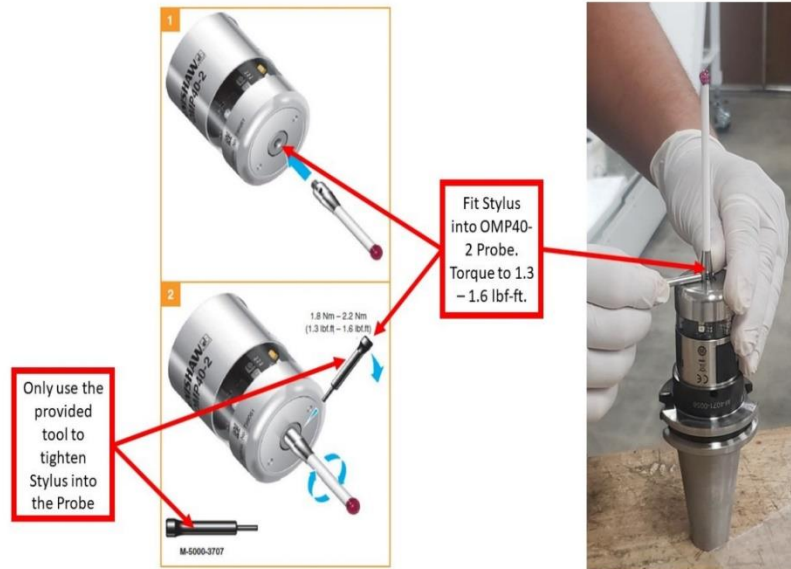

2. Attach the OMP40-2 Probe into the CAT40 Shank (P/N: 34080-8) by using a 2mm flat Allen Wrench to secure the six (6) set screws, as indicated in the image. There are two (2) upper pointed set screws, and four (4) lower flat set screws to secure the OMP40-2 Probe to the CAT40 Shank. Torque each set screw to 0.4 - 1.1 lbf-ft.

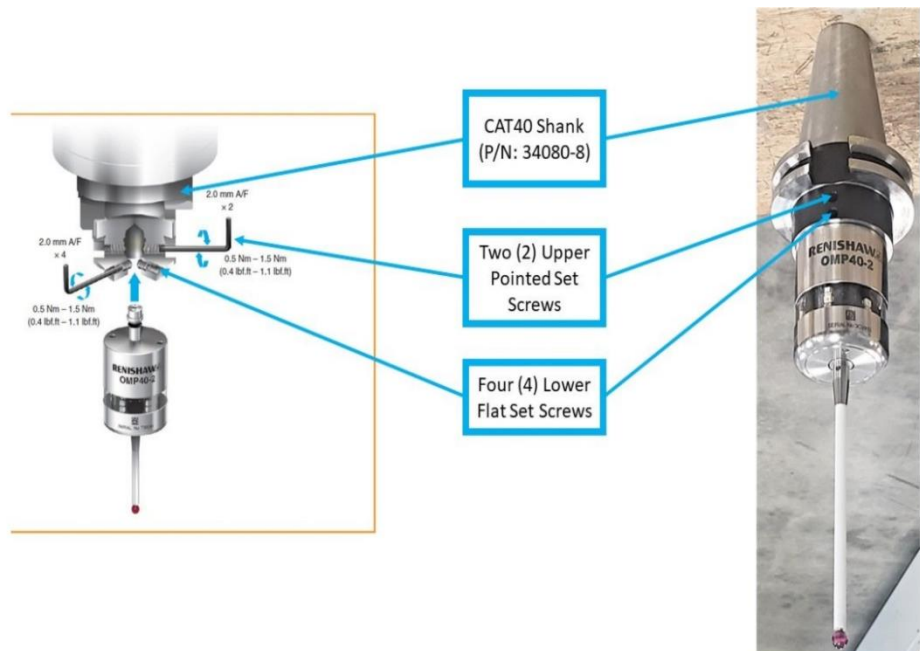

3. Install Retention Knob (P/N: 26800-2) to the CAT40 Shank. It is now ready to be installed into the spindle.

Install Retention Knob (P/N: 26800-2) to CAT40 Shank



4. With OMP40-2 Probe in the spindle, use a dial indicator to measure the runout of the Stylus Ball while spinning the Probe by hand. For initial calibration of the OMP40-2 Probe, the maximum tolerance for runout is $\pm 0.0004''$. As shown in the image, use the four (4) lower flat set screws on the CAT40 shank to minimize the runout by loosening and tightening opposing screws in pairs. Adjust until maximum tolerance for runout is achieved.

INITIAL CALIBRATION

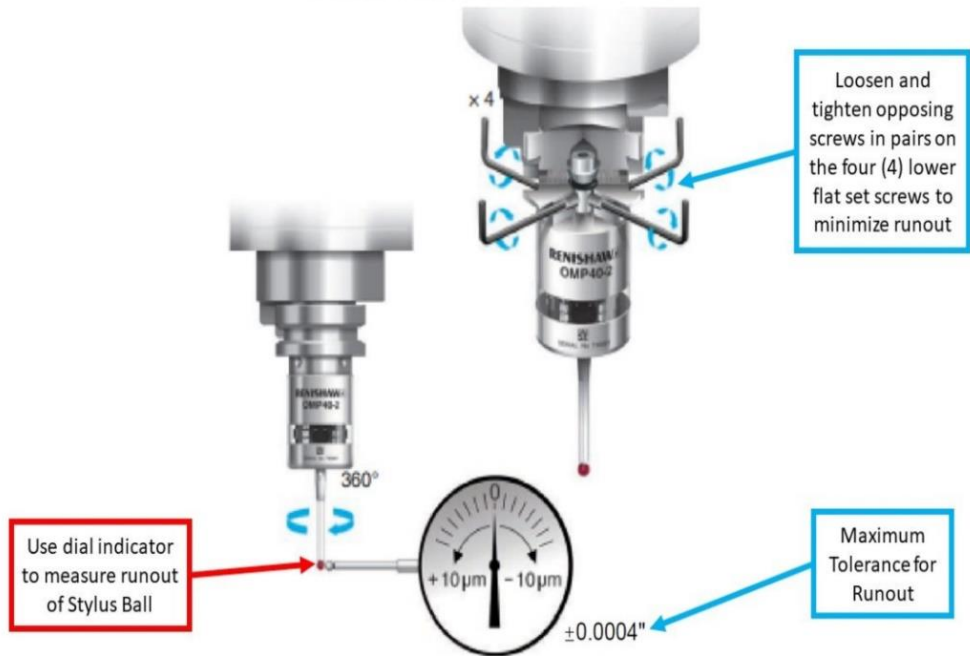

5. Next, use the two (2) upper pointed set screws on the CAT40 shank to minimize the runout by loosening and tightening both opposing screws. Adjust until maximum tolerance for runout is achieved.

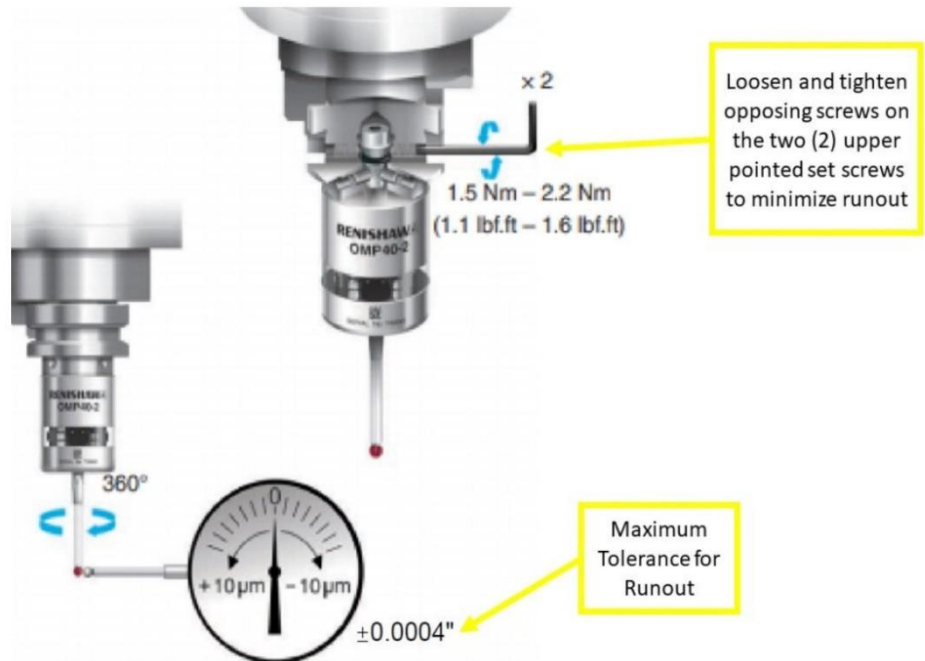

FINAL CALIBRATION

6. For the final calibration of the OMP40-2 Probe, the maximum tolerance for runout is +/- 0.0001". As shown in the image, use the four (4) lower flat set screws on the CAT40 shank to minimize the runout by loosening and tightening opposing screws in pairs. Adjust until final maximum tolerance for runout is achieved.

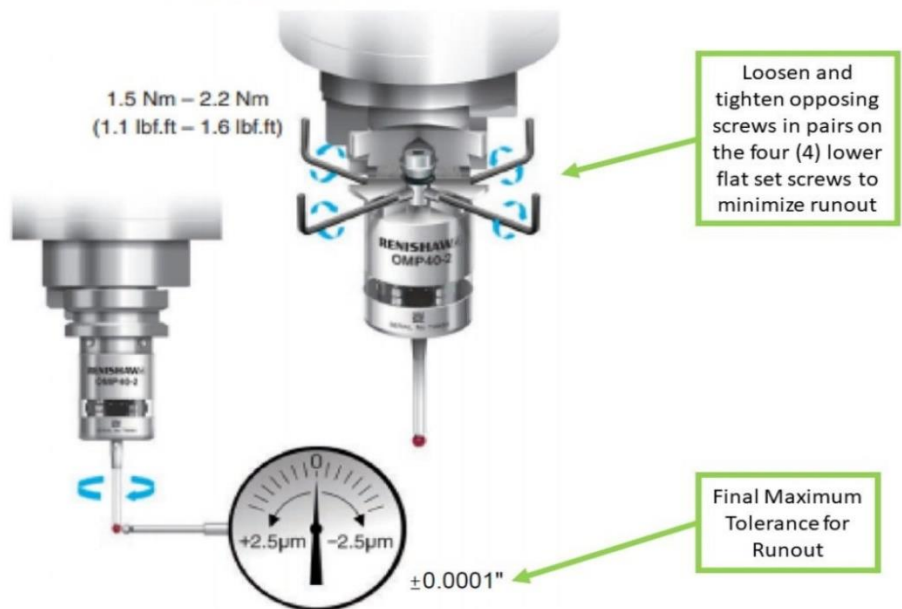

7. The following procedures detail how to set up and calibrate the OMP40-2 Probe within the Siemens control of the VMCsi. Select JOG on the Machine Control Panel (MCP).



8. Next, manually set up the probe. (1) Press the second left-side bar shortcut key (Tool List), and (2) select a location that is outside of the ATC tool list (not in locations #1 to 24). Next, (3) press the VSK "New tool" on the right side of the screen.

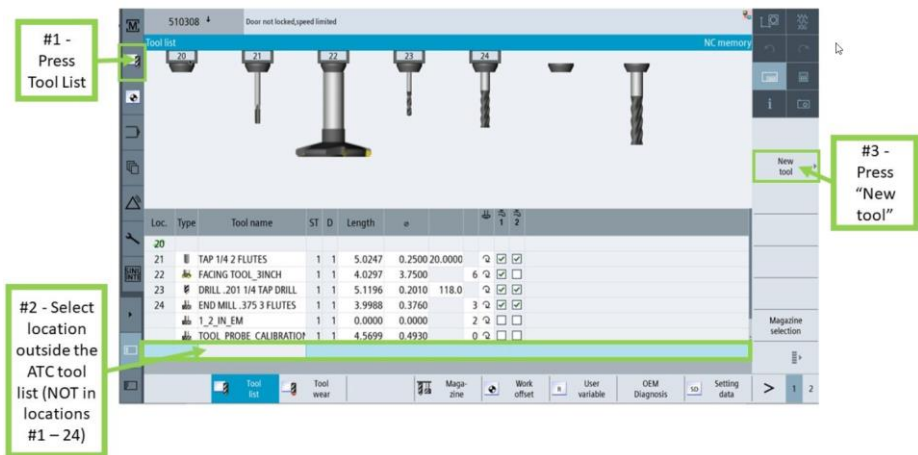

9. The "New tool - favorites" window will appear; (1) choose "710 - 3D probe" from the list, and then (2) press VSK "OK" to add it as a new tool type.

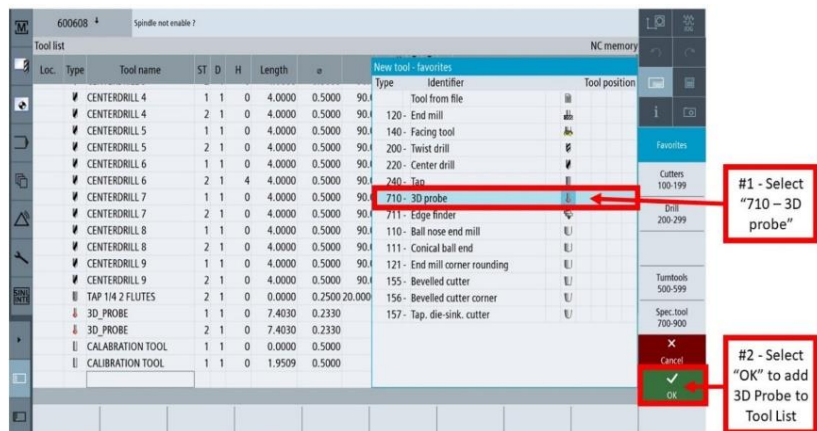

10. Enter the length and diameter of the 3D Probe Tool on the "Tool list" window. (1) Use a dial caliper to measure the tool length of the OMP40-2 Probe from the tip of the tool to the top of the flange, plus an additional 1/4" (see image). Note: A tape measure works to get a rough length for use with the tool setter to get final accurate measurement. (2) Enter this number under the "Length" column.

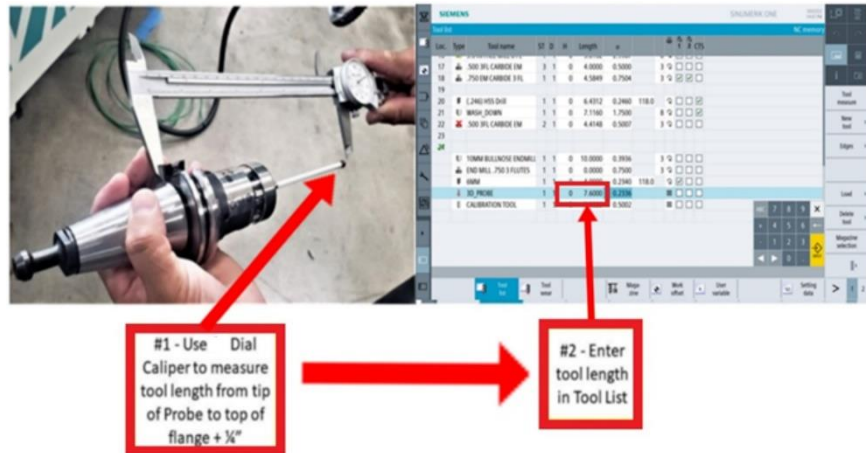

11. (1) Use a dial caliper to measure the diameter of the OMP40-2 Probe's Stylus Ball, and (2) enter this number under the "ø" column. This diameter will also be on the packaging for the stylus. The ones we ship with the machine are 6mm (0.236").

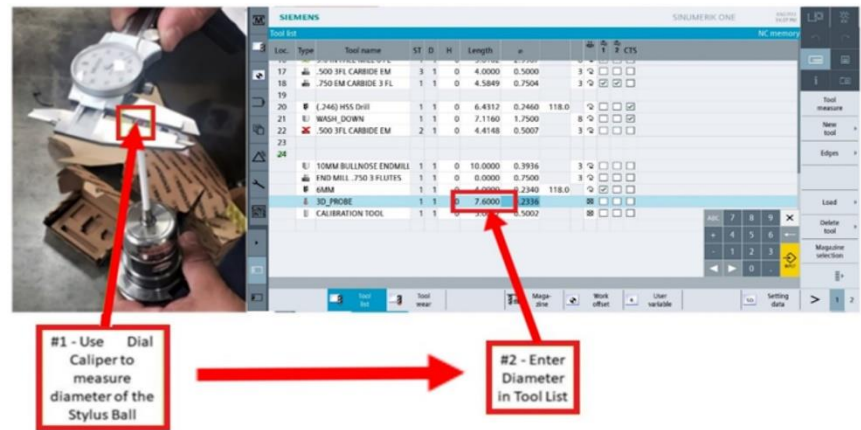

12. Set your work offset before you proceed. Press (1) the "T,S,M" button from the HSK, press (2) the "Work offset" which gives you a pop-up menu. Press (3) "G54". G54 is an example, you can select any offset.

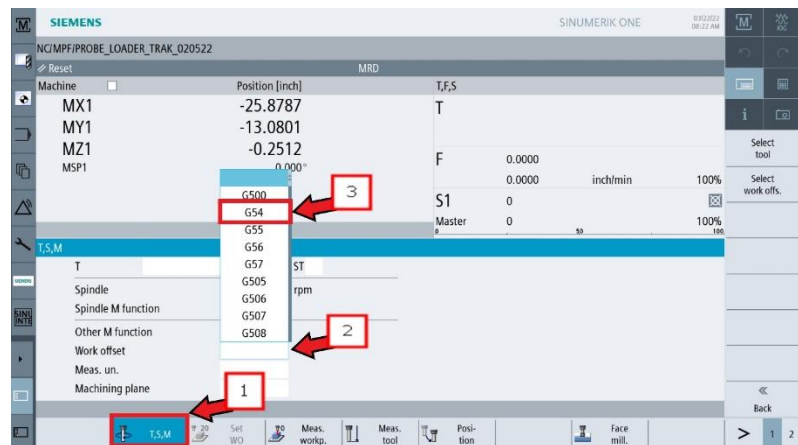

13. Press "CYCLE START" on the MCP and you will see the indicated field appear with G54 displayed.

Next step press "Select tool".

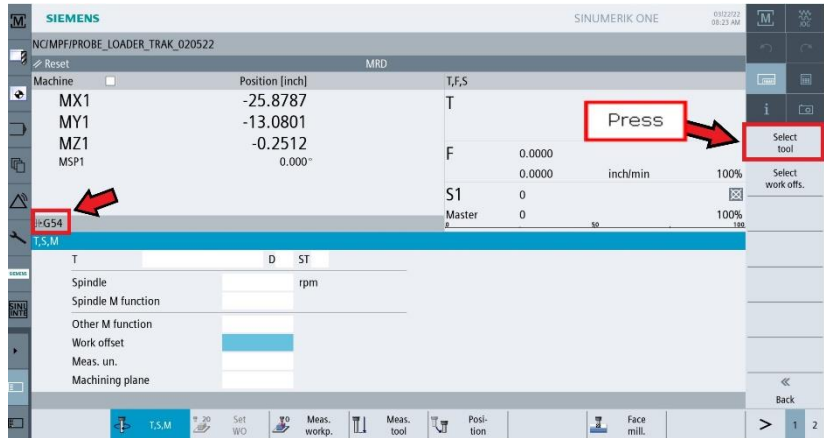

14. Press "Tool list" from the HSK and check if your calibration tool is in the list. If it is defined, skip the next 3 steps and go to Step 17. Otherwise complete the next 3 steps to MANUALLY LOAD the calibration tool.

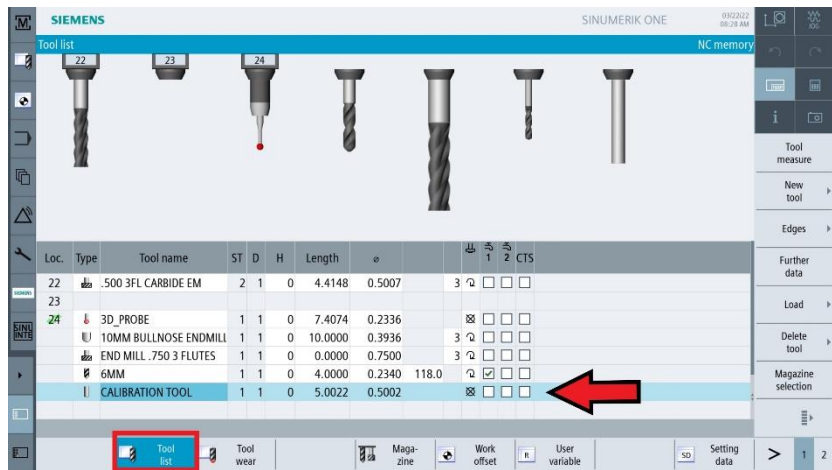

15. MANUALLY LOAD1: The "New tool - favorites" window will appear; select the VSK "Spec. tool 700-900" on the right, then choose "725 - Calibrating tool" as the new tool type. Press VSK "OK".

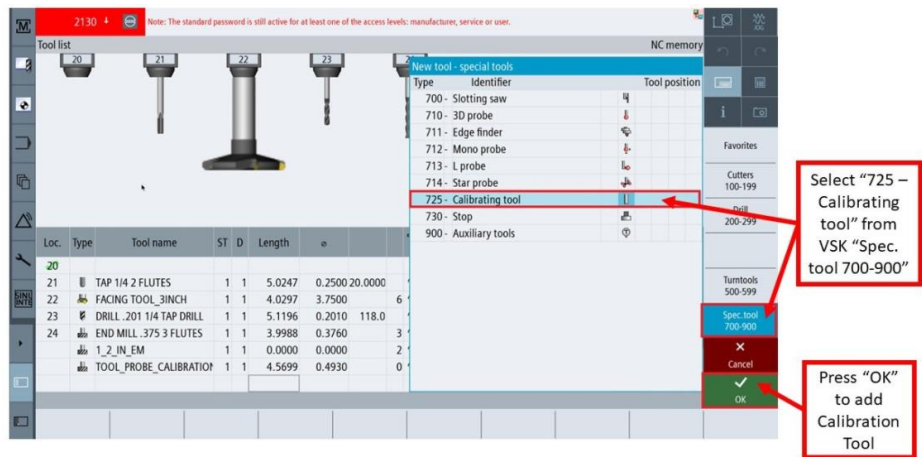

16. MANUALLY LOAD2: Once the calibration tool has been added to the tool list, enter the length and diameter for the calibration tool using pop-up keypad. Inset photo shows measurement data found engraved on calibration tool

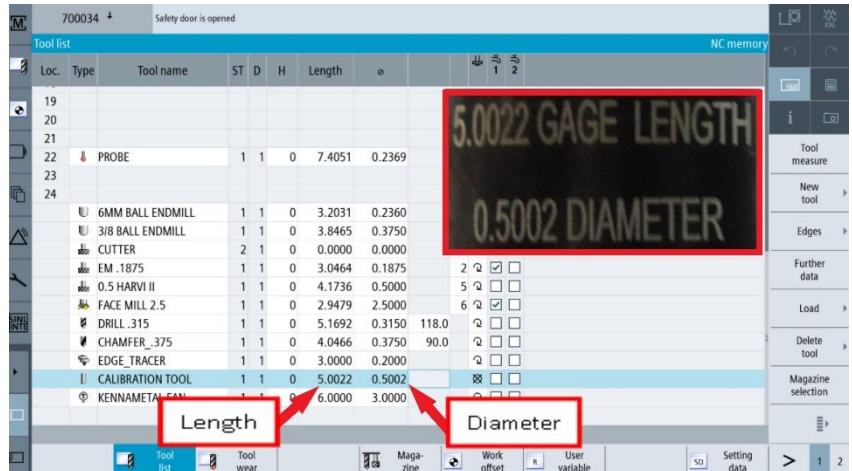

17. MANUALLY LOAD3 the Calibration Tool into the spindle through the following. Press Jog button on MCP at upper left corner, press (1) HSK "T,S,M," and then click on the (2) VSK "Select Tool". Press CYCLE START follow prompts to open door, enter calibration tool in spindle and press CYCLE START again.

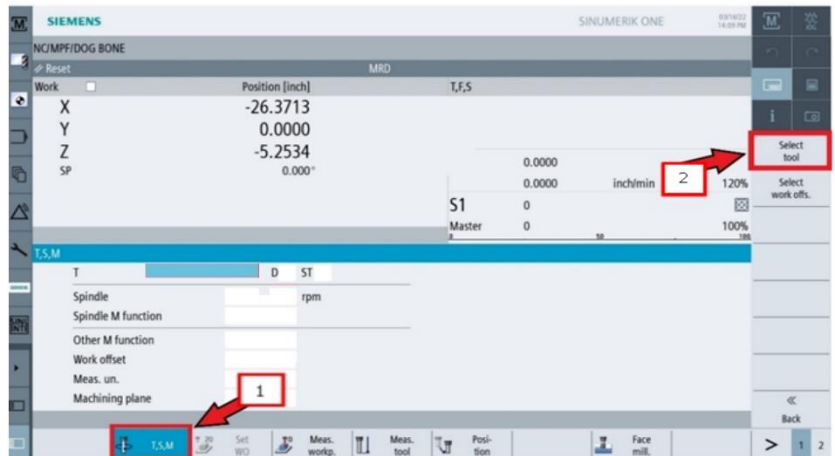

18. To set your reference, lower the calibration tool below the 123 blocks. Then bring it up slowly until the block barely slides under the calibration tool.

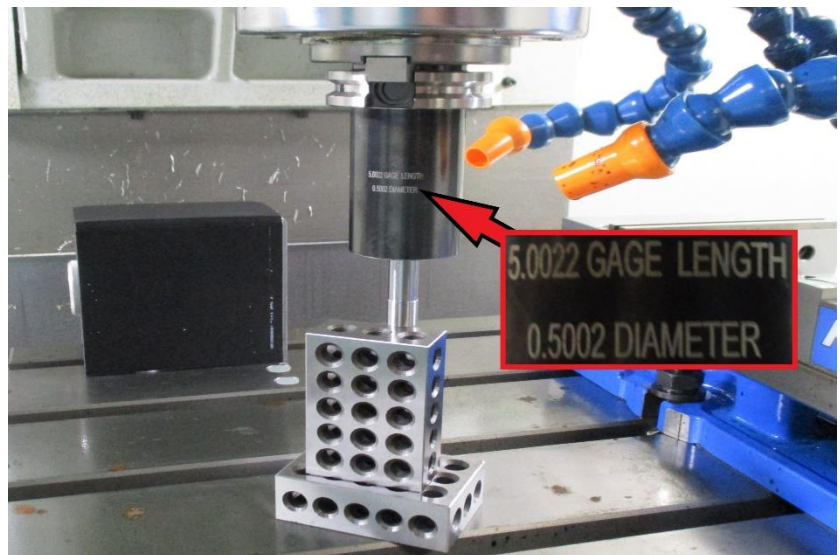

19. (1) - Toggle the "Act values machine" button on the right VSK to remove the blue highlighting which (2) changes the axis to display work offset values.

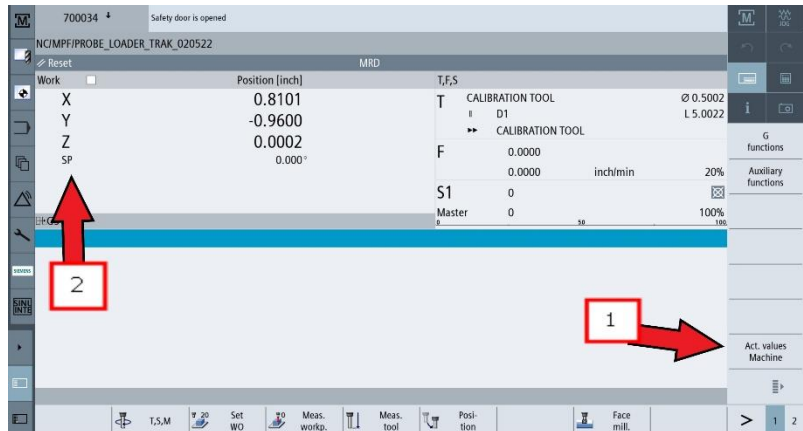

20. (1) - Press "Z=0" on the right VSK which zeros out the Z axis position as shown at (2).

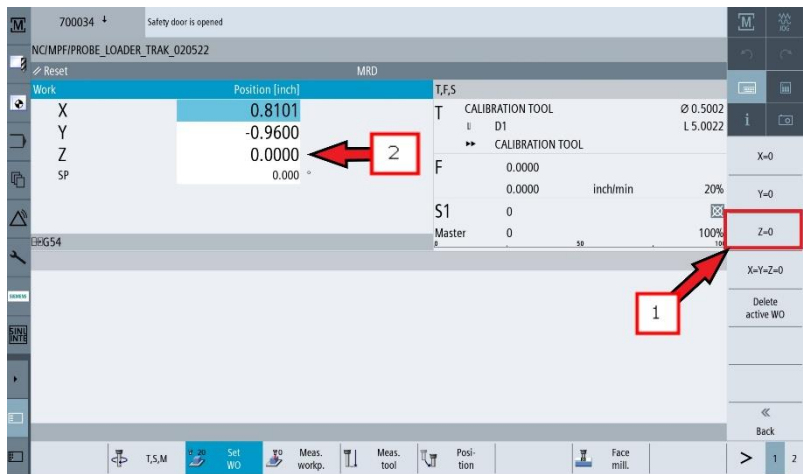

21. Manually load the OMP40-2 Probe into the spindle through the following steps. (1) Press the HSK "T,S,M," then (2) click on the VSK "Select Tool."

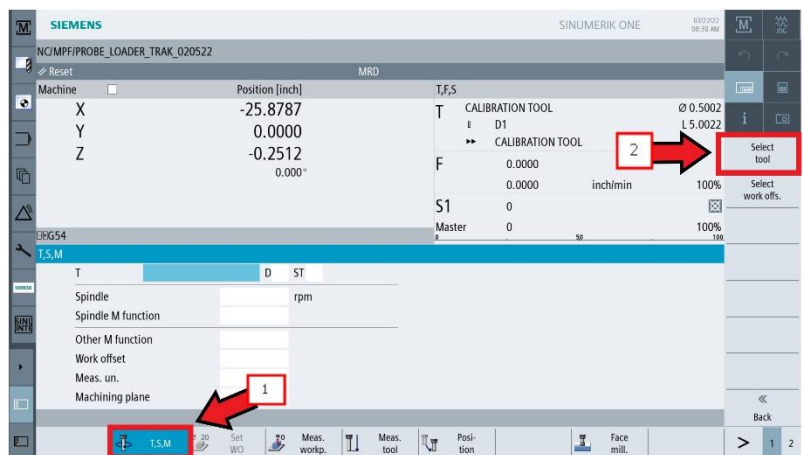

22. From the "Tool selection" window, (1) click and choose the 3D Probe Tool, and (2) hit VSK "OK."

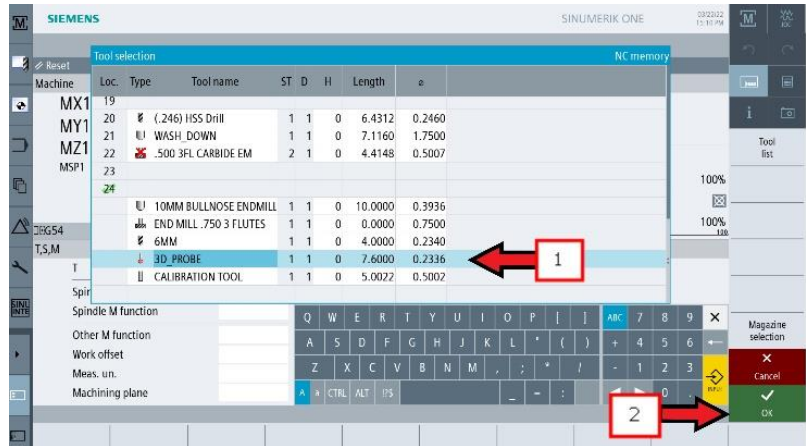

23. As prompted by the screen, press CYCLE START on the MCP. Press DOOR OPEN to unlock and open the machine doors.



24. Manually load the OMP40-2 Probe into the spindle, and then close the doors. Press CYCLE START on the MCP again.



25. (1) From the HSK press "Meas. Workp." Then (2) press "Calibrate probe" from the right VSK.

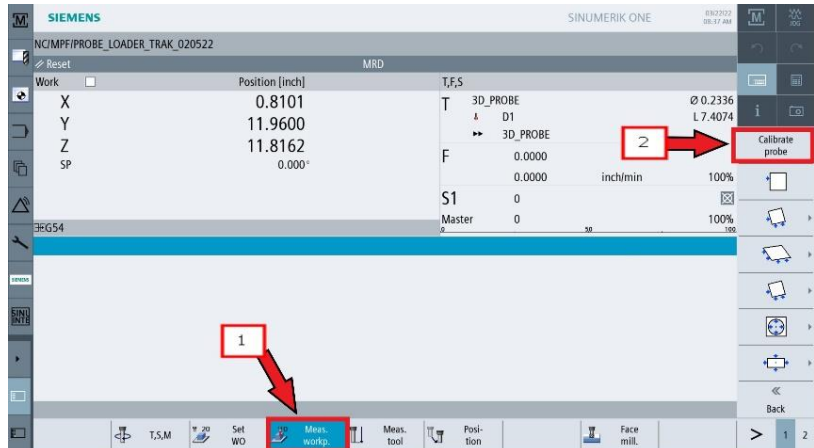

26. (1) From the right VSK press "Length" and highlight "Z0" and enter "0". Set probe about 1/2" above 123 blocks, close door and press CYCLE START.

Note: Probe will go down and touch the block and reset tool probe length.

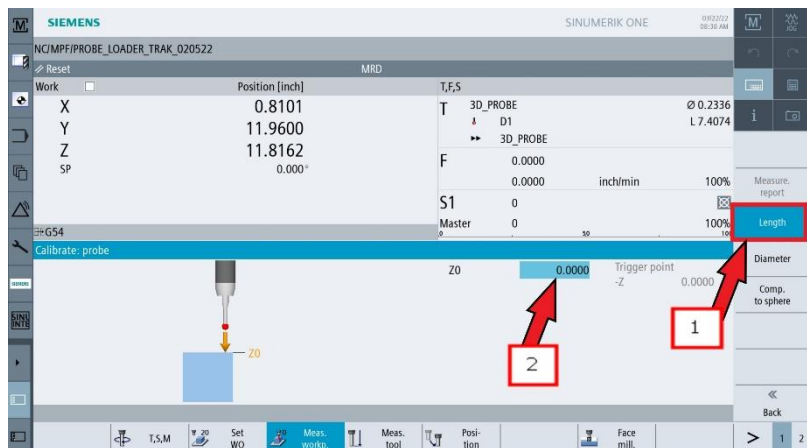

27. (1) – You should see a Trigger Point of "0" displayed. Once the above steps have been completed, the "T" field under the "T,F,S" section should now be populated with the 3D Probe Tool information. (2) – Your actual length is displayed after the "L".

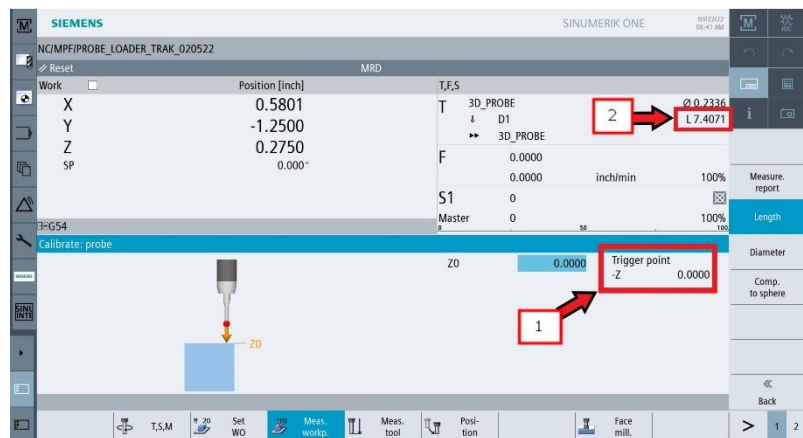

28. Calibrate the diameter of the OMP40-2 Probe through the following steps. As shown on the image, replace the two (2) 1-2-3 Blocks with a Ring Gauge. Note the Ring Gauge's diameter, and place it near the center of the worktable. Jog the spindle until OMP40-2 Probe's Stylus Ball is located inside the center of the Ring Gauge.

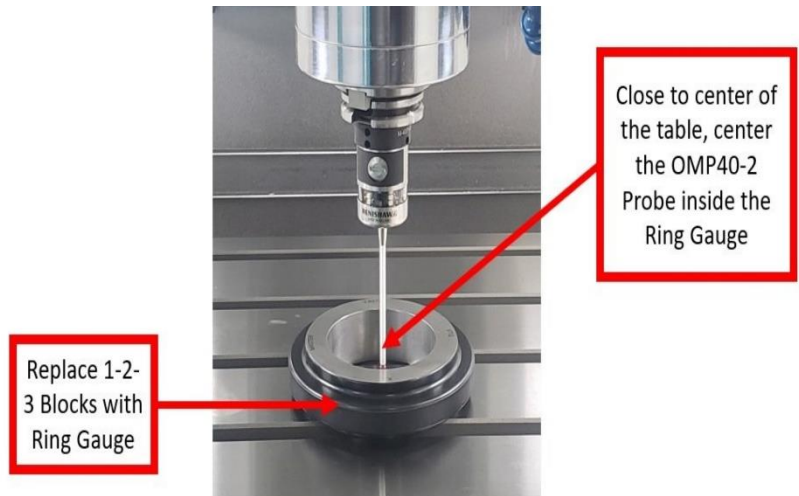

29. Back to the "Calibrate: probe" window, (1) click the VSK "Diameter." (2) Enter the Ring Gauge's diameter (in inches) under the \varnothing field (as shown on the image).

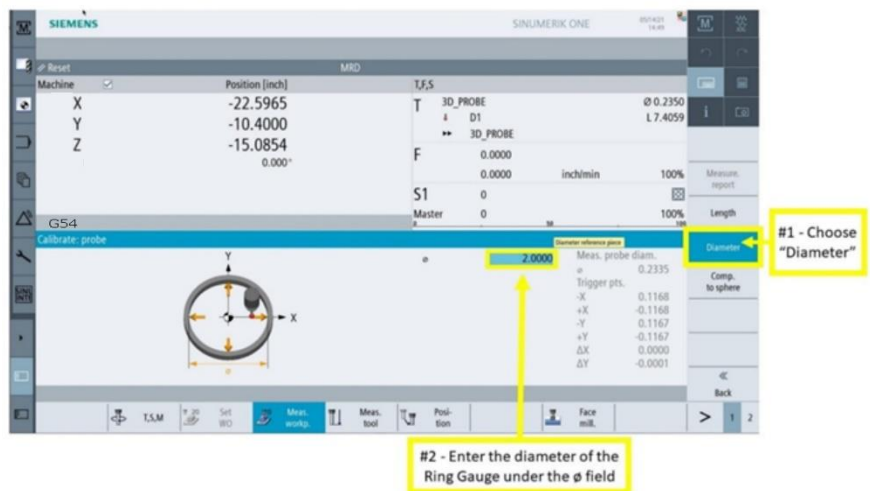

30. Click CYCLE START on the MCP. As shown on the illustration on the screen, the OMP40-2 Probe will touch all sides of the Ring Gauge.

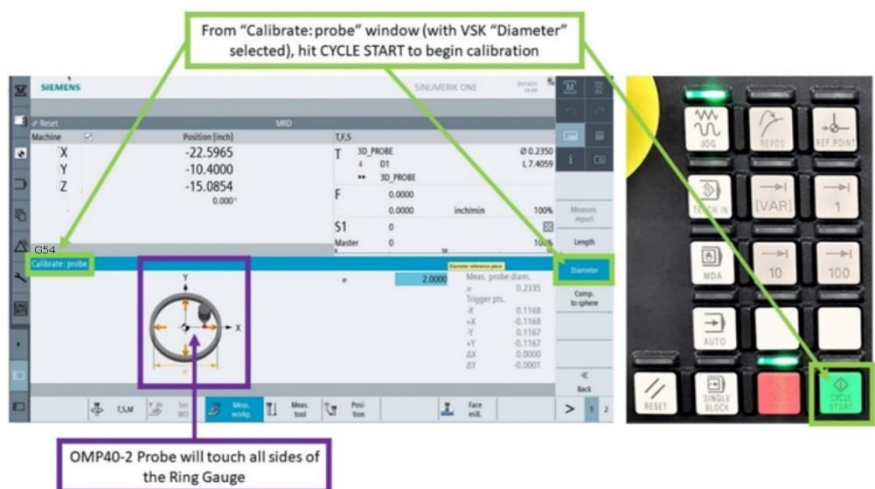

31. Once calibration ends, the "Calibrate: probe" window will show the final Machine Values and Trigger Points. In accordance to the Inspection process for the OMP40-2 Probe, conduct the Calibrate Probe Diameter steps above three times, and take note of the Machine Values and Trigger Points each time. Ensure that these values remain consistent throughout this process.

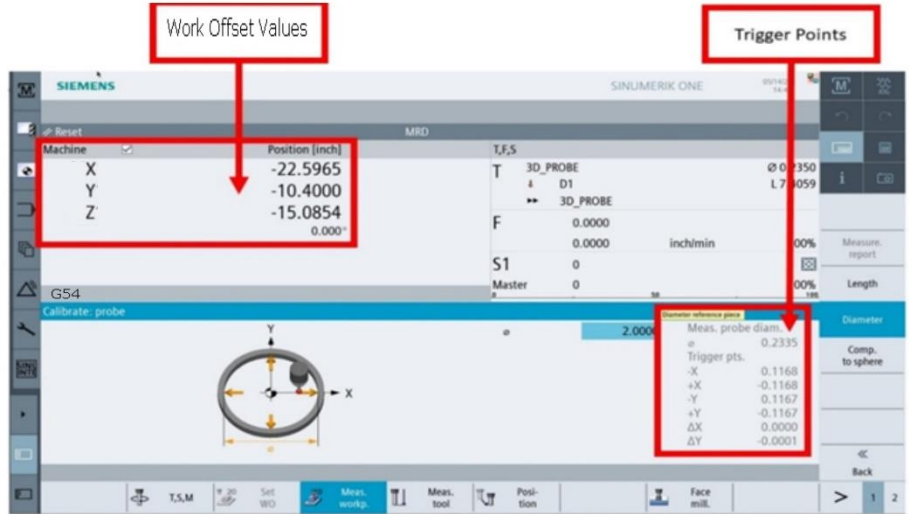

2.16 Lubrication

2.16.1 Way Lubrication

The auto lube system provides centralized automatic lubrication for the linear guides and ballscrews. The lube pumps 1-liter reservoir is serviced with ISO VG 32/SAE 10W slideway oil.

Lubrication is activated for 10sec in following cases:

- 1) When Machine control lube push button is pressed, the lube pump turns on for 8 secs.
- 2) When the machine is turned on, the lube pump turns on for 8 secs.
- 3) The lube pump cycles every time the machine is turned on.

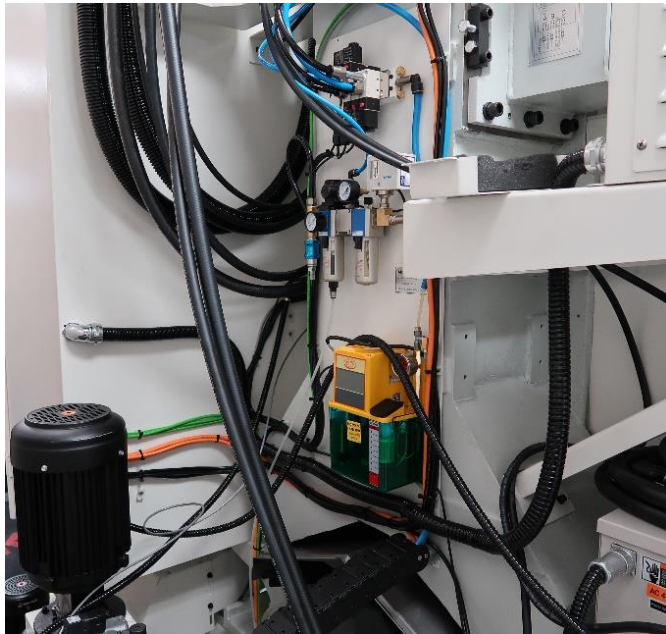

VMC7/10si Lube Pump



VMC12/14si Lube Pump

Discharge Pressure - Approximately 200 psi

To adjust the amount of Discharge Pressure displayed on the lube pump gauge, turn the adjustment screw clockwise to increase the pressure. 1 turn of this screw will raise the pressure about 100 psi.

At the beginning of each day, check the oil level in the Auto Lube system. If low, fill with ISO VG 32/SAE 10W slideway oil. If the lube pump runs dry or has low pressure, a warning message will appear at the top of the screen. To manually activate the lube pump, press "Lube" button on the MCP which runs pump about 7 seconds.

2.16.2 Other VMCsi Lubrication Points

1. Tool Change Air Cylinder Oil Cup supplies oil to the "Air Over Oil" cylinder which should not require replenishment. However, if it does fill the oil cup on the front of this cylinder with ISO VG 32/SAE 10W slideway oil.
2. Oiler
Once every 2 weeks, fill the oiler that supplies lubrication to the solenoid valves and other various components within the pneumatic system with ISO VG 32/SAE 10W slideway oil. It holds approximately 5 ounces.
3. See Section 4 Automatic Tool Changer (ATC) for specific maintenance requirements.

2.17 VMCsi Machine Specifications

MODEL NAME	VMC7si	VMC10si	VMC12si	VMC14si
Table Size	35.43" X 19.69"	44.09" x 19.69"	51.18" x 23.62 1300 x 600 mm	62.99" x 23.62" 1600 x 600 mm
T-Slots (number x width x pitch)	5 x 18 x 100 mm 5 x .709" x 3.937"	5 x 18 x 100 mm 5 x .709" x 3.937"	5 x 18 x 125 mm 5 x .709" x 4.921"	5 x 18 x 125 mm 5 x .709" x 4.921"
Travel (X, Y, Z axis)	30" x 20" x 20"	40" x 20" x 20"	50" x 27.5" x 25"	60" x 27.5" x 25"

Spindle Info	VMC7/10si	VMC12/14si
Spindle Power (continuous) Assumes 480 volts	15 KW 20.1 HP	20 KW 26.8 HP
Spindle Power (peak)	31 KW 41.5 HP	50 KW 67 HP
Power at Spindle with 1 to 1.25 pulley ratio (continuous) Assumes 480 volts	12 KW 16.1 HP	n/a
Power at Spindle with 1 to 1.25 pulley ratio (peak)	24.8 KW 33.2 HP	n/a
Spindle Motor Torque (continuous)	72 N-m or 53 ft-lbs at 2000 RPM 96 N-m or 70.8 ft-lbs at 500 RPM	98 N-m or 72 ft-lbs at 1750 RPM 125 N-m or 92 ft-lbs at 500 RPM
Spindle Motor Torque (peak)	148 N-m or 109 ft-lbs up to 2000 RPM	240 N-m or 177 ft-lbs up to 1750 RPM

Spindle Info	VMC7/10si	VMC12/14si
Torque at Spindle with 1 to 1.25 pulley ratio (continuous)	57.6 N-m or 42.4 ft-lbs at 2500 RPM 76.8 N-m or 56.7 ft-lbs at 625 RPM	n/a
Torque at Spindle with 1 to 1.25 pulley ratio (peak)	118.4 N-m or 87.2 ft-lbs up to 2500 RPM	n/a
Spindle Taper	40 Taper	
Spindle Speed Range	10-12000	
Tool Clamping force (90 psi)	1500 lbs	2200 lbs
Tool Holder Type	CAT 40 standard BT40 optional (must change ATC arm)	
Spindle Nose Diameter	3"	3.75"
Diameter of spindle	60 mm	70 mm
# of Spindle Bearings	4 total - 2 lower and 2 upper	
Spindle Bearing Sizes	95 x 60 x 18 mm	110 x 70 x 20 mm
Spindle Cooler Oil Capacity	4 liters ~ 1 gallon	16 liters ~ 4.25 gallons

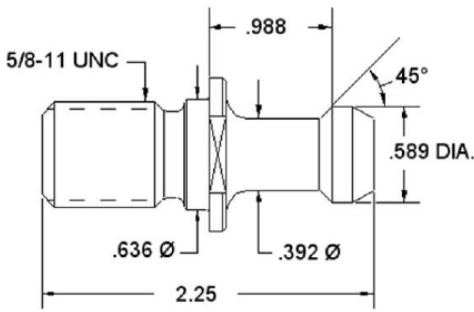
ATC Info	
ATC Tool Capacity	24
Maximum tool weight including holder	8 Kg 17.6 lbs
Maximum tool diameter	78 mm 3.07"
Maximum tool length	300 mm 11.81"
Arm ATC tool change time	2.5 seconds
Retention knob	Same one used on all TMC and VMCsi machines 

Drive Train Specs	VMC7/10si	VMC12/14si
# of X, Y and Z axis linear bearing blocks	2	2
X, Y and Z axis linear guide size	35 mm	45 mm

Drive Train Specs	VMC7/10si	VMC12/14si
X axis linear guide way span	300 mm	380 mm
Y axis linear guide way span	530 mm	900 mm
Z axis linear guide way span	386 mm	440 mm
X, Y and Z axis ballscrew diameter	32 mm	40 mm
Pitch of ballscrew (X, Y and Z axis)	10 mm	10 mm
Ballscrew accuracy class	C3	C3
Rapid traverse X, Y, Z	1000 ipm	
Cutting max speed X, Y, Z	1000 ipm	

Power Requirements	VMC7/10si	VMC12/14si
Power – 480 (volts, phase, current)	480V (456-504V is acceptable), 3P, 41A	480V (456-504V is acceptable), 3P, 69A
Power requirements with transformer option (volts, phase, current)	208V with transformer (198-218V is acceptable), 3P, 94A	n/a

Coolant System	VMC7/10si	VMC12/14si
Coolant Pump (watts)	750	750
Coolant Wash Pump (watts)	750	1290
Pressure and Volume Coolant Pump	32.8 liters/min at 3 kg/cm2 8.7 gpm at 42 psi	32.8 liters/min at 3 kg/cm2 8.7 gpm at 42 psi
Pressure and Volume Coolant Wash Pump	32.8 liters/min at 3 kg/cm2 8.7 gpm at 42 psi	66.3 liters/min at 3 kg/cm2 17.5 gpm at 42 psi
CTS Coolant Through Spindle Pump (watts)	3 KW 4.02 HP	3 KW 4.02 HP
CTS Pressure and Volume	22.4 kg/cm2 or 2200 Kpa 319 psi Maximum of 15.4 gallons/min	22.4 kg/cm2 or 2200 Kpa 319 psi Maximum of 15.4 gallons/min
Tank Capacity	60 gallons	78 gallons

Machine Specs	VMC7si	VMC10si	VMC12si	VMC14si
Maximum Weight of Workpiece	600 Kg 1230 lbs	800 Kg 1760 lbs	1000 Kg 2200 lbs	1200 Kg 2640 lbs
Height of table from bottom of floor ***	38"	38"	42"	42"
Minimum spindle nose to table distance****	3.5"	3.5"	3"	2.5"

Machine Specs	VMC7si	VMC10si	VMC12si	VMC14si
Maximum spindle nose to table distance****	23.50"	23.50"	28"	27.25"
Distance of ATC arm to table.	20"	20"	25.75"	25"
Spindle Center to spindle head casting face	18.25"	18.25"	26.75"	26.75"
Minimum machine height ***	93.5"	93.5"	106"	106"
Maximum machine height (head all the way up) ***	108"	108"	119.25"	119.25"
Minimum height to fit VMC's through doorway **	88.25"	88.25"	98.75"	98.75"
Length (pendant enclosure rotated at 90° and coolant tank in place)	127.75"	127.75"	147.50"	147.50"
Overall width of machine with side doors close and chip conveyor in place with no chip bin	144.25"	144.25"	168.25"	180.00"
Overall width of machine with side doors open. Chip conveyor in place but no chip bin which adds width	4496 mm 177"	4496 mm 177"	202.63"	226.25"
Overall length of machine with electrical cabinet full open 180° and pendant enclosure rotated 90°	150.25"	150.25"	156.63"	156.63"
Footprint of Machine (width x length) (chip conveyor /coolant tank in place) Pendant enclosure not rotated 90°	3615 mm x 2786 mm 144" x 112"	3615 mm x 2786 mm 144" x 112"	168.25" x 126.50"	180" x 126.50"
Weight (lbs.)	8360	9900	15400	17600
Shipping Weight (lbs.)	8710	10250	15900	18100

Air Requirements	VMC7/10si	VMC12/14si
Air – Pressure CFM or SCFM	2.5 CFM (at 90 psi), or 18 SCFM	3.0 CFM (at 90 psi) or 25 SCFM
Air Quality	Air dried/ water separator upstream of the VMCsi	

Lube Requirements	VMC7/10si	VMC12/14si
Lube Pump Capacity	2 liters	
Lube Oil	ISO 32 or 10 W	

* Specs subject to change

2.18 Siemens Euclid Block Procedure

The test part should be machined at the completion of the installation.

The material for the Euclid block test part is found in the toolbox.

- Material Specification: Aluminum, 6061-T6 or T4
 - Blank Size: (minimum dimensions) 3 x 3 x 1", provided in tool box
 - Tool: .750 end mill, 2 flute, high speed steel, **sharp**
 - Coolant: Flood coolant, Cool-Tool or Kerosene
1. Mount vise and indicate the back jaw parallel to the table within .0005".
 2. Clamp material in vice with a minimum of .800" above the vise jaws.
 3. Load in the Euclid block program. At the Siemens touchscreen, use left side VSK and press "Program manager", open up the "Workpieces" directory and then the "VMC_INSPECTION PROGRAMS" directory. Click on the program "Euclid" to run and follow instructions.
 4. Use an edge finder to set Absolute 0 on X and Y. Absolute zero is the front left corner of the block as viewed from in front of the machine.
 5. Load the .750 end mill and set Z Absolute 0 at the top of the part, and set Z total length offset in the tool table.
 6. Begin to run the program. The part will be machined in the following sequence:

Event(s) #	Description	Depth of Cut
1	circle pocket – cuts middle circle	-0.250"
2	circle profile – cuts outer 1.830 diameter circle	-0.250"
3	circle profile – removes extra material outside of circle	-0.250"
4	milling event - removes extra material outside of triangle	-0.250"
5-12	irregular profile – cuts material from corners remaining on Euclid block and cuts triangle on Euclid block	-0.500"
13	rectangular frame – cuts outer 2.750" rectangle	-0.750"
14	position event – check for accuracy of circle	0.050"

7. After the program runs, the program will locate to the following position.
 - a. X = 1.318
 - b. Y = 1.318
8. Mount a dial indicator in the quill and check the circles using figure 2.14 as a reference.
9. Check the runout of the sides of the square frame.
10. Inspect the machined surfaces for smoothness.

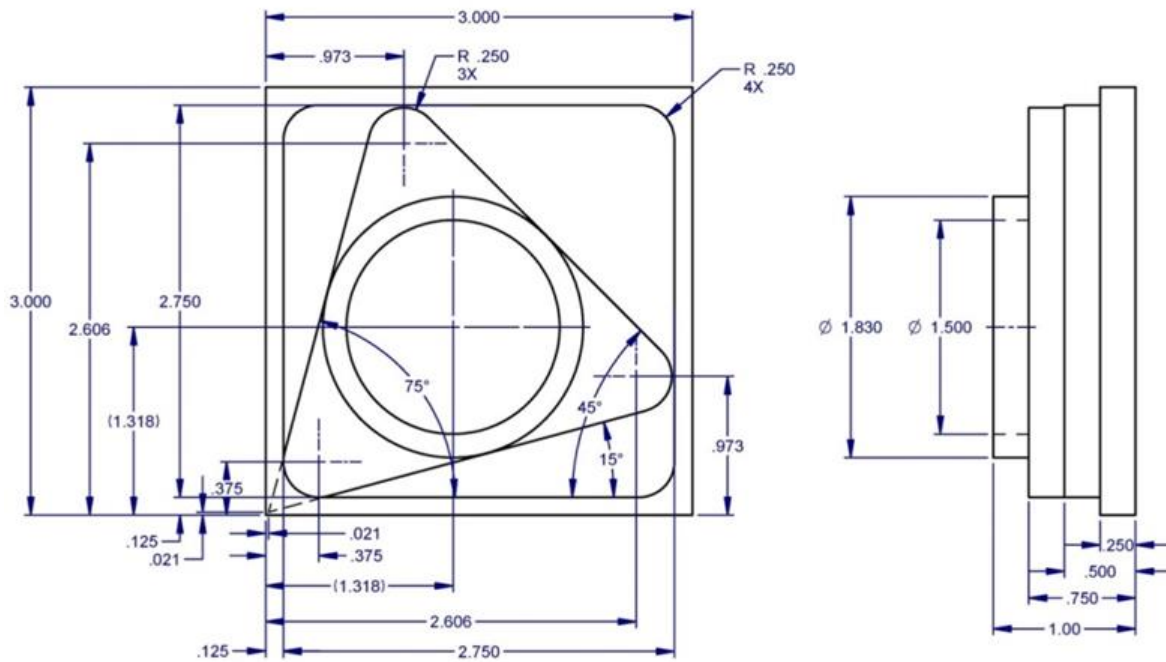

I15537-1

3.0 Troubleshooting

This section provides a guide to check possible repairs for a number of problems found while operating a VMCsi mill. This may help customers to find the source of simple problems. If this guide does not solve the problem call TRAK Customer Service at (800)-367-3165.

3.1 Flashing or Dark Machine Control Panel (MCP)

Reported problem is from a known good mill that starts to flash or has a dark non responsive MCP.

1. Possible message shown as MCP fails or flashes "Failure of machine control panel 1".

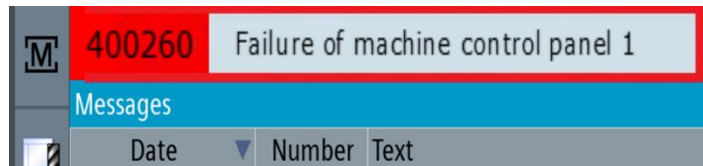

2. Check network cable connection from PPU to MCP see figure 3.1.

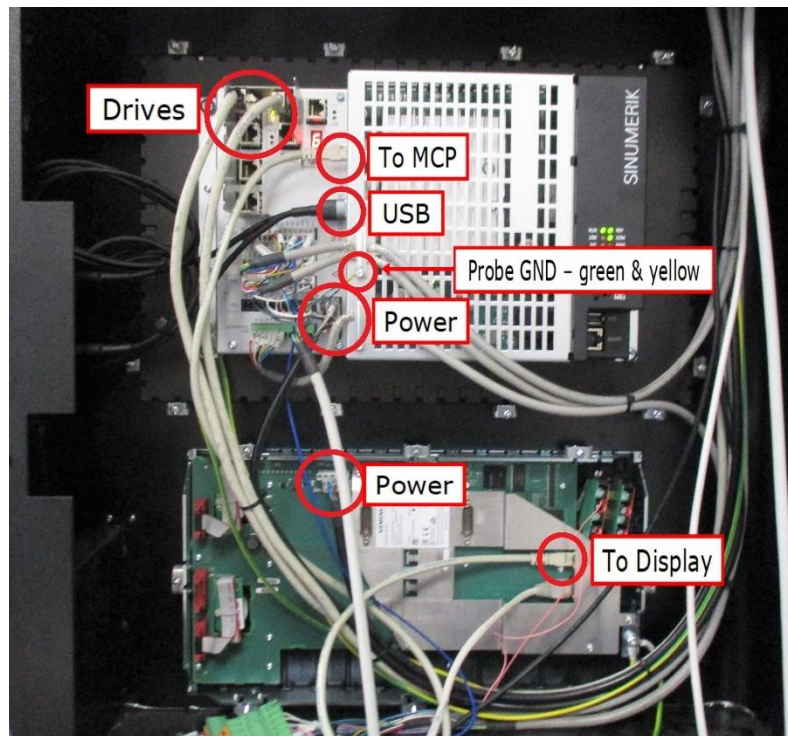

Figure 3.1 MCP Connections

3.2 Handwheels Do Not Work

Reported problem from a known good mill with working EHW that stop working.

1. Check condition of the EHW remote.
2. Remove rear cover of pendant and check wires from the EHW to pendant.
3. Check wires from the EHW to pendant. If needed open pendant rear cover and check wires from bottom of pendant to the individual wires on X134 connector as shown in figure 3.2. Verify wires are continuous and tight from the EHW to the pendant and inside the pendant to X134 connector.

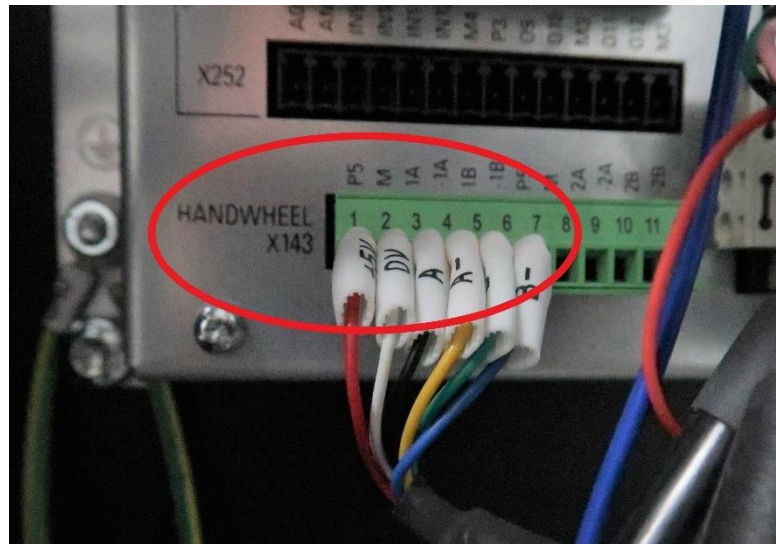

Figure 3.2.

3.3 No Signal from the Probe

Probe is designed to turn on when inserted into spindle. When green or red probe signals are not working, check the connecting cable from the inside upper left corner of the mill and follow to pendant see figure 3.3a to check all 6 wires and 1 jumper for proper connections.

See figure 3.1a for the probe wire routings to make sure the connections are secure.

Check figure 3.3b to verify power cables to probe from electric cabinet are connected.

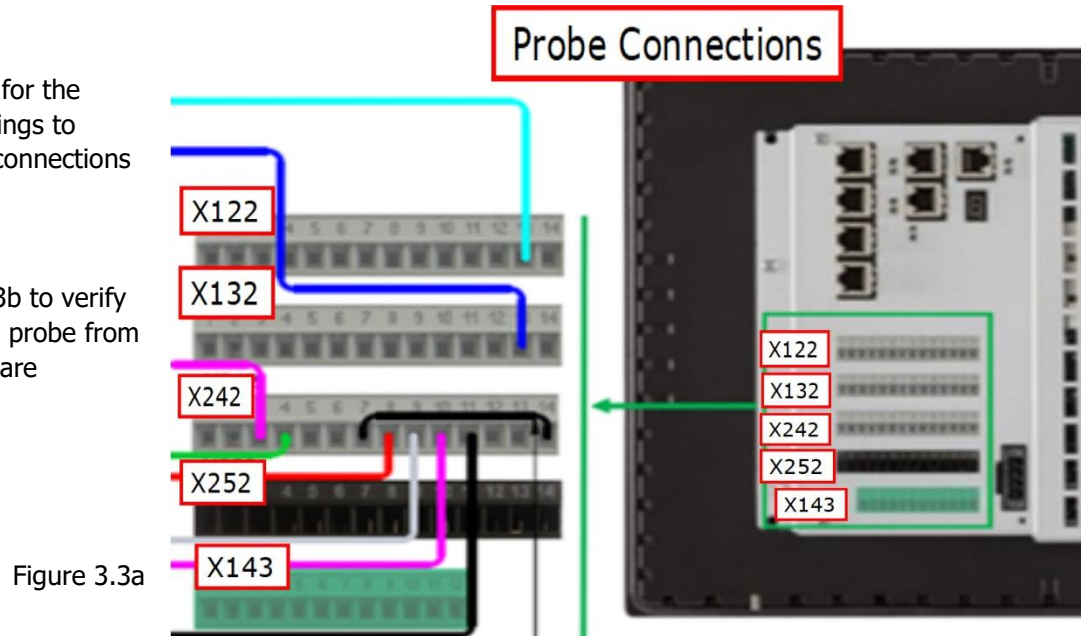

Figure 3.3a

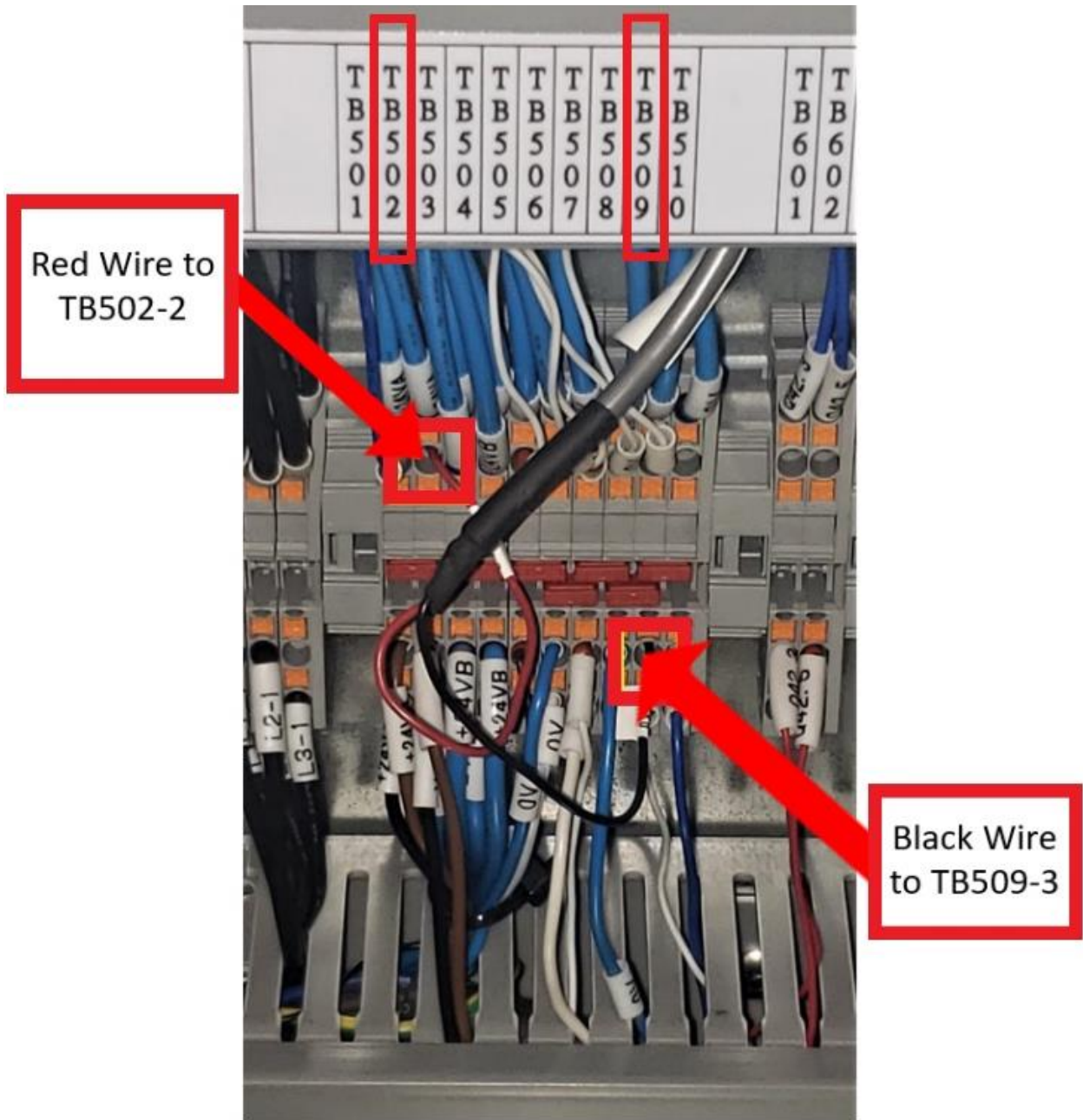
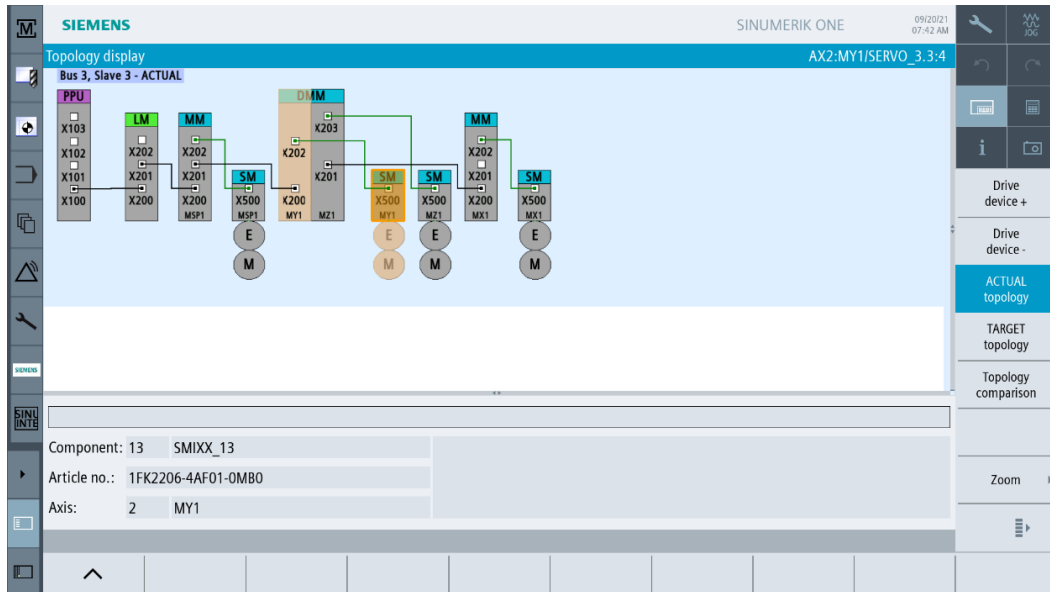

Figure 3.3b

3.4 Check Defective Drive System Using System Topology

Using system Topology Screens will help detect drive system problems. Sinumerik system screens have the capability to show in real time the system topology.

From the left VSK, press "Setup", then from HSK press "Drive System" and "Topology" which will display the actual topology layout of the system in real time.



Using the right VSK, press "Topology comparison" and the actual system report is displayed below the system design when all is working correctly. Problems with the mill are noted when colors changed and problem components are grayed out on the Actual system topology.

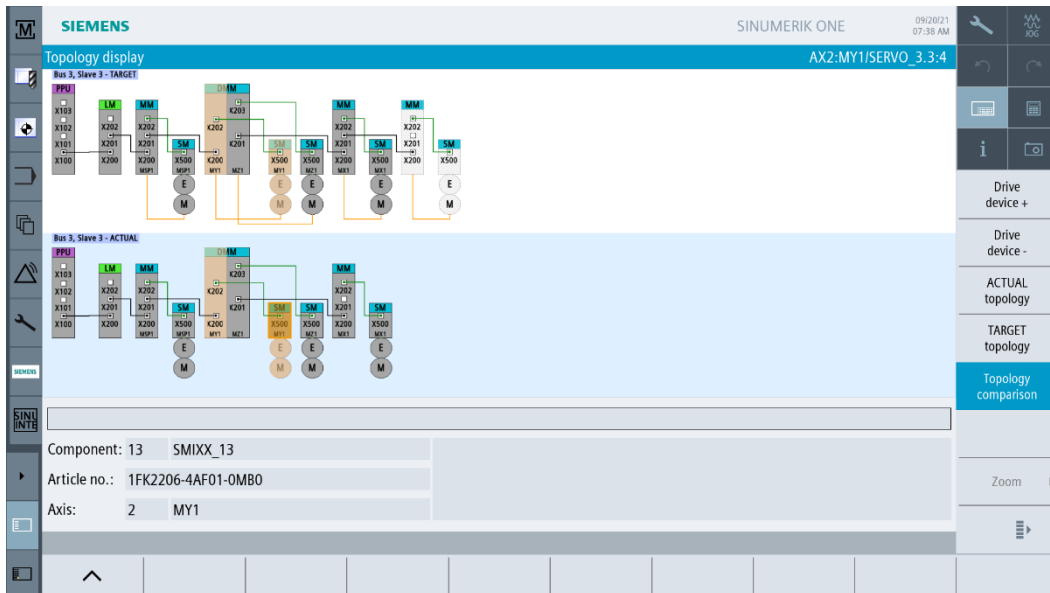

3.5 Check Alarm Log for Errors

From the left VSK, press the DIAG Triangle, then press "Alarm list" from the HSK. The Alarm list is shown below that displays current alarms until the situation is resolved

Review the list for errors related to the current issue and note an error in Topology as well as an Encoder fault.

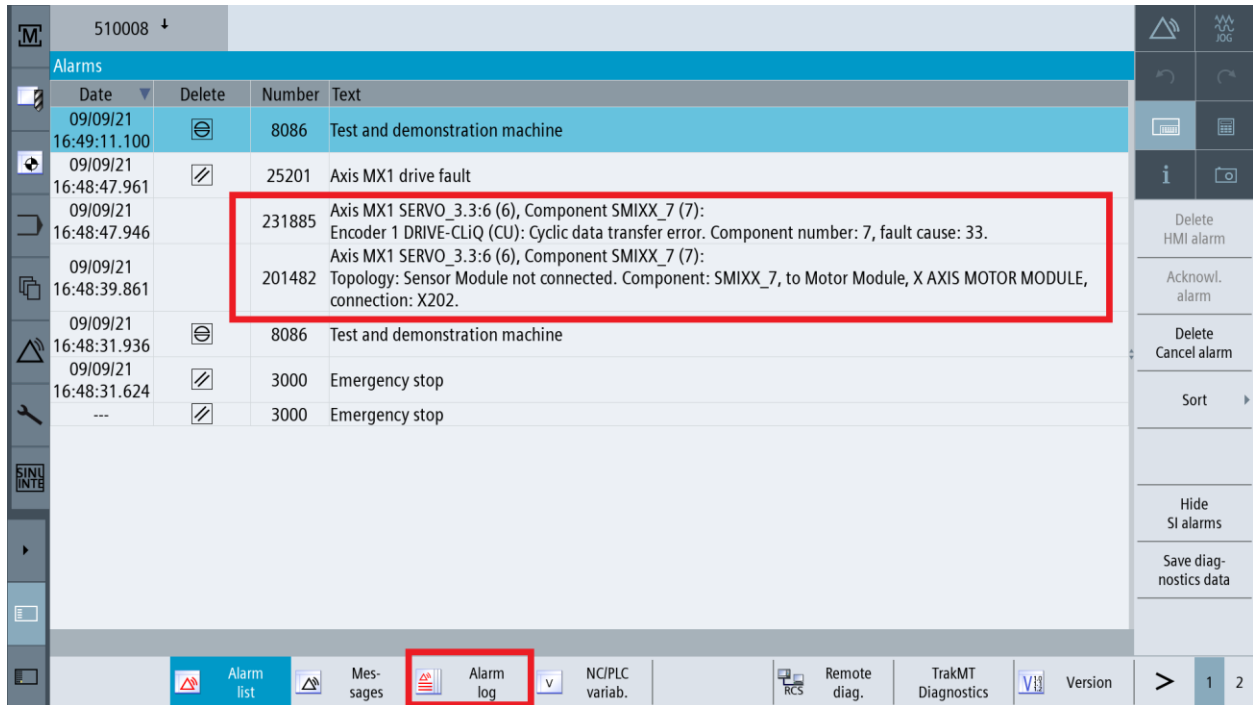

You can print out a copy of the complete alarm log if needed for troubleshooting purposes. Press "Setup" go to page 1 of the HSK and press "System data". Traverse the screen and press "HMI Data" then "Logs" and find the "Alarmlog.txt" file. See section 3.7 for instructions to print this file to your USB.

3.6 ATC Magazine Rotates the Wrong Direction

Occasionally the magazine position will rotate the opposite direction than directed.

The most likely cause is rotation of the magazine with the machine initially wired backwards so the magazine directions are reversed. If this happens, first confirm that the machine is wired correctly. This can be checked by jogging the magazine position with the MCP and verifying the direction of rotation or turning on a coolant pump and verifying the motor direction is correct.

Note the coolant and coolant wash pumps operate clockwise. The optional CTS pump operates counterclockwise. (See figure 3.8) If other parts of the mill are also working opposite than their designed direction, it is possible that the leads on the main wiring for the mill are reversed.

To home the tool magazine all buttons are found on the MCP:

1. Press "JOG"
2. Press "REF. POINT"
3. Press and hold "MAG" hard key and while holding it press the "+" hard key on the bottom right of the MCP. The magazine should rotate until pot one is in line with the spindle, confirm in the tool table that this represented properly on the control display (you should see green arrows on location one).



Figure 3.8

3.7 ATC Magazine Out of Sync with Control Display

Occasionally the magazine position has become out-of-synch with the control display. Typically, this is when the green arrow in the first column of the tool table is pointing at a different number than the tool change pot position.

Press "JOG", "REF" "MAG and "+" to sync magazine number with the tool number in the tool change table.

3.8 Pendant Screen Print

For troubleshooting purposes, it is helpful to take a screen print of the controller as many times as needed to help document an issue and then research solutions.

To make and save a screen print:

1. The active operating screen always displays a camera outline. Press the camera icon to take a screen shot on any screen see figure 3.8.
2. Select "Setup" "Sys data" from the HSK, on the screen scroll and click "HMI DATA", "Logs", "screen shots". The files are time stamped so you can find the ones you want with the name SCR_SAVE_Number.
3. The right side VSK have buttons to make files easy to copy. From the screenshots directory and press "Mark" on a file then select one or more files. Files are highlighted in yellow, press "Copy". At the top of the file list will be your USB installed on the right edge of the pendant. Highlight your USB (either TOP or BOT) and press "Paste" to your desired directory on the USB see figure 3.8b.

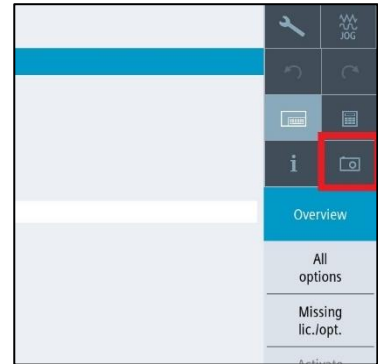

Figure 3.8 Camera Icon

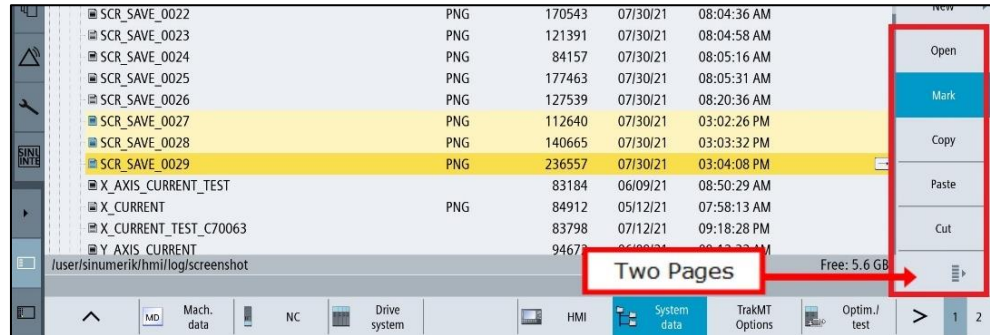

Figure 3.8b Copy Files

Note: You can also open a screenshot for viewing and the delete option is on the VSK right side second page.

It is suggested to remove screen prints from the memory of the controller by highlighting one or more files and pressing "Delete". There is limited memory space which should be left for programs.

4.0 Automatic Tool Changer

4.1 Service Intervals

Monthly

- Visually inspect pots for damage
- Remove white plastic carousel cover and inspect carousel grease to make sure it has not been washed out along slideway
- Check cam box oil level (Figure 4.1f)
- Inspect arm for straightness, damage and nicks/burrs (Figure 4.1g)



Figure 4.1f

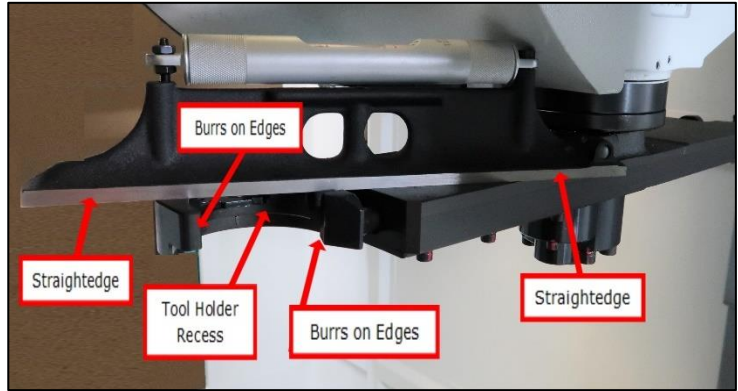

Figure 4.1g

Quarterly

- Add grease to: Carousel outer surface Slideway (Figure 4.1i), Segmentation Cam (Figure 4.1j), Disc Bearings (Figure 4.1h), Pot lift/Lower T Slot (Figure 4.1i).
- Disassemble, clean, inspect and regrease ATC arm spring and plunger mechanism (see Maintenance Steps)

Annual

- Disassemble, clean, inspect, and regrease carousel assembly incl., segmentation cam (Figure 4.1j, disc bearings (Figure 4.1h), slideway (Figure 4.1i), pot lift/lower T slot (Figure 4.1i)
- Inspect carousel main bearings for smooth rotation, dirt, wear (see Maintenance Steps)
- Drain and refill cam box oil. (see Maintenance Steps)

4.2 Maintenance Steps

4.2.1 Arm Spring and Plunger Mechanism



Figure 4.1h Disk Bearings

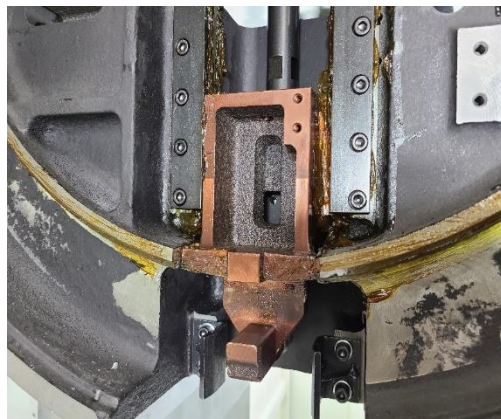

Figure 4.1i Pot Lift/Lower T Slot & Slideway



Figure 4.1j Segmentation Cam

1. You need to remove the Pots and Carousel for this service. Disk Bearings are located on the backside of the carousel which also gives access to the Segmentation cam, Pot Lift/Lower T Slot area and complete access to 360° of the slideway.
- 2.

ATC Arm

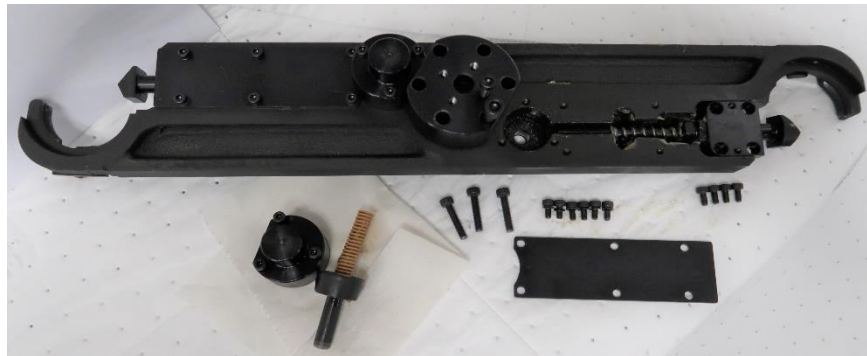



Figure 4.1k Plunger Mechanism

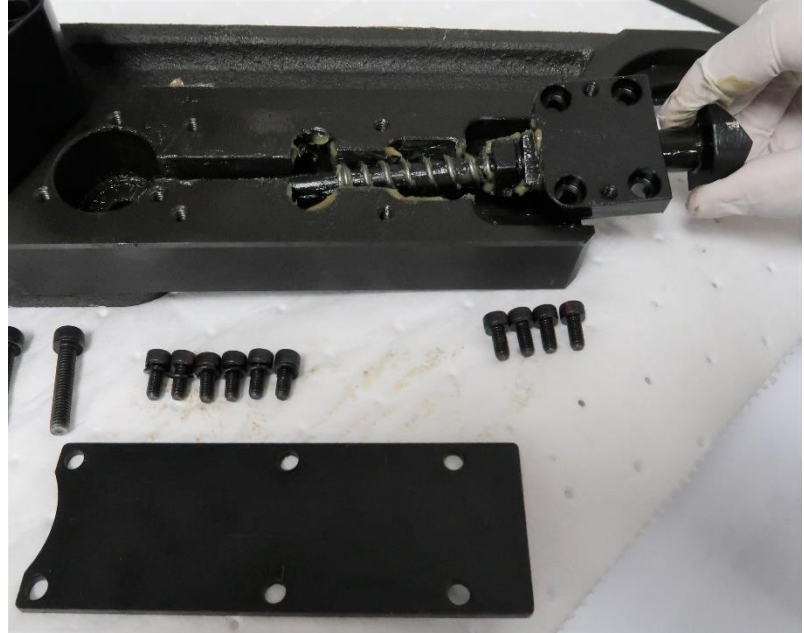

Figure 4.1L ATC Arm Springs

4.2.2 Cam Box

1. Motor has a brake arm that needs to be lifted when manually rotating. Lift the arm, open the rubber cap on top, and use a socket and ratchet to rotate the cam box through its full range of motion (see figure 4.1a).
2. Make sure you put the brake back on after servicing. If not on, the arm will over travel on the cam.
3. The brake is technically serviceable, but we will just be replacing the motor as a whole assembly.
4. Sight glass on front, accessible under front cover.
5. There is an oil filler cap on the front and rear of the top of the housing. These are connected, and either one can be used. The front one will likely be much easier to access during servicing. The drain is on the front bottom of the casting.
6. Oil used is Shell Omala 220#
7. 3.8L capacity

4.2.3 Cam Box Oil Change

1. Do not fill cam box with recycled oil.

Use only clean lube oil.

2. Fill lube oil until level reads in the

Range shown in the window below:

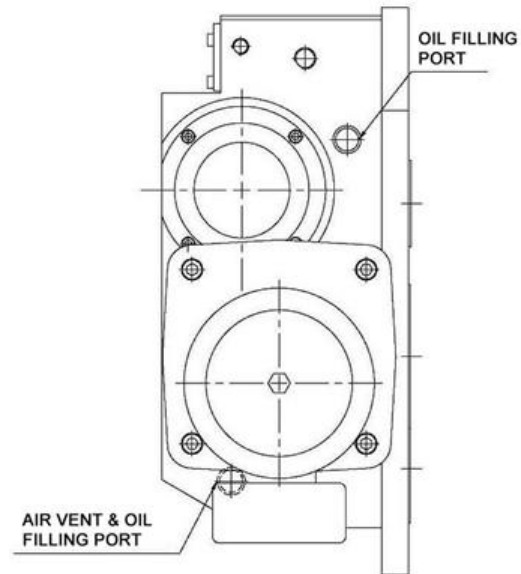
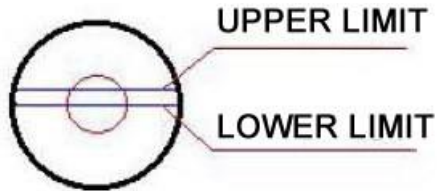

4.2.4 Carousel

1. The carousel needs greasing along the bearings, internal to the bearings (they are simple bearings, not ball bearings), along the perimeter that the pots slide along (slideway), and the segmentation cam. The T slot block and rails that the pots are actuated via also needs to be greased.
2. To grease everything, you can reach in between the carousel spokes and apply grease to all surfaces. Cycle the carousel and apply to any inaccessible spots.
3. A full service does not need to be done as often. This requires removing the disc, cleaning the grease out, and replenishing with fresh grease. The pot lift/lower block can stay in place, and the T slot rail caps can be removed, everything cleaned, and regreased. The disc bearings need to be removed by using an allen wrench on the bearing side, and loosening the nut on the other side. Then, remove the bearing race and inner shaft, pack with grease, and reassemble. Blue Loctite recommended. No shims or spacers needed when working on the bearings.
4. Grease used is High-Lube L2 high temp grease (NLGI grade 2)
 - i. Our Mobilith SHC 100 grease should be sufficient here. It should be a high temp, moisture resistant grease with good pressure ratings. The loads are fairly low in this application compared to true bearing contact and speeds. Basic bearing greases are applicable here.
5. The disc facial runout was indicated at being within +/- .004" at the furthest machined point. It is not precision machined. OD runout at the lip was +/- .003". We probably do not need to worry about tight alignment here.

4.2.5 Pots

1. The pots have been tested for up to a million cycles, however misalignment, heavy tools, dirty environments, etc., can accelerate any wear.
2. If the pots begin to fail, they may begin dropping tools or the plastic may elongate to where the springs and balls come loose.

4.3 ATC or Swivel Head Service Mode

Warning:

Possible injury could result while using this powerful feature of the control. Without an understanding of the ATC and tool change functions an operator could easily cause injury or damage their mill. Read and understand the complete Service Mode section before attempting this type of service.

4.3.1 Benefits of Service Mode

ATC or Swivel Head Service mode allows manual control of the tool changer for maintenance reasons as well as to correct situations when the ATC is in an error state or there is a problem with the operation. This could be due to many reasons; the ATC arm is in a nonresponsive position, E-Stop was pressed in the middle of a tool change, or there is a problem with a tool in the spindle.

4.3.2 Considerations Before Using

The most important items to understand before using are:

- Is the tool change height correct? (See section 4.4) Note: Spindle higher than arm will prevent accidental arm hitting the spindle.
- Is the spindle oriented correctly? (Reference TRAK Public Dozuki Site: VMCsi - Set Orientation Angle & Tool Change Height)
- If arm stopped during change, is there a tool or tools in the grippers? (See section 4.3.5)

The next thing to understand is the ATC Tool Change Cycle:

Note: Tool Change cycle can do one or two tools at the same time.

1. From home position, arm swings over to grab tool(s)
2. Unclamp spindle then one end of the arm grabs from spindle the tool in its arm gripper. The other end of the arm grabs from the pot the tool in its arm gripper (if present).
3. Arm moves down to clear tool holder from spindle and/or pot, arm spins 180° and moves back up into tool change position
4. Clamp spindle then both ends of the arm are clamped with or without tools present.
5. Arm moves back to home

Service mode has the operator in control of the mill in total manual mode so there is no automatic checking of operations. **WARNING:** This is where the force of the arm can become dangerous. The operator can manually force a tool change with a lot of force on the arm and spindle. Even in manual mode, the ATC moves with a great amount of force. It is quite possible to damage the mill or tools in this mode with a crash that could also hurt the operator. Service personnel using this mode must understand this manual level of control of the mill and its consequences.

4.3.3 MCP Buttons Used

When in ATC Service mode, you will have control of the buttons; "ATC POT", "MAG", "ARM", "+", and "-". This allows a wide range of manual movements of the ATC without control protections, see Section 4.3.2 Considerations Before Using above.

Brief description of three buttons on the MCP when pressed along with "+" or "-" select forward or reverse motion:

ATC POT – Will activate the tool pot at the tool change position, lowest place on magazine.

MAG – Rotate the magazine one or more positions

ARM – Cycle the ATC arm

"+" (plus) – Operates the selected function forward

"-" (minus) – Operates the selected function in reverse

4.3.4 How to Use

ATC Service mode will allow manual control of the complete tool change process. This will usually be done to fix some unusual damage or repair. When you move the ATC arm manually to the spindle you can perform a tool change so the clamp cylinder must be either ready to unclamp the tool when removing or clamp the tool when placing a tool in the spindle. The operator will need to manually operate the spindle clamp/unclamp air control and understand when to clamp the spindle tool and when to unclamp the spindle tool. Note that the air control will stay on or stay off after being pressed.

IMPORTANT: Complete Before Use

Confirm two correct settings of the ATC before using Service Mode, Tool Change Height and Spindle Orientation. Instructions are as follows:

1. How to find tool change height:

Important to have the spindle at the correct height to perform a tool change. In case of some problem and the tool height is suspected to be incorrect, or want to verify the correct dimension; Press "SETUP" > Mach. data >

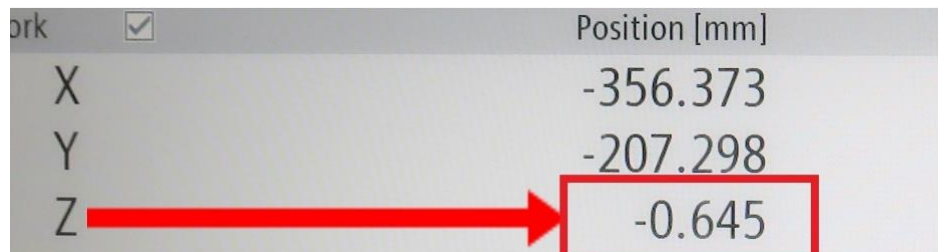

Axis	Position [mm]
X	-356.373
Y	-207.298
Z	-0.645

Axis MD > SET AXIS = AX3 (use buttons on the right VSK increment to AX3:MZ1) > search 30600. Manually either confirm the setting is correct or change the Z axis (shown in image) to the value stored in field 30600 for AX3.

2. Set Spindle Orientation to Tool Change Position:

Press [M] on the upper left VSK and then select "T,S,M" from the HSK. 1 - Press the "Spindle M function" right side data field and select the spindle alignment icon from the drop-down menu as shown. 2 - Another data field to the right appears where you input a "0" using the numeric keypad and press "INPUT". Press "Cycle Start" on the pendant keyboard to have the spindle move to the tool change position

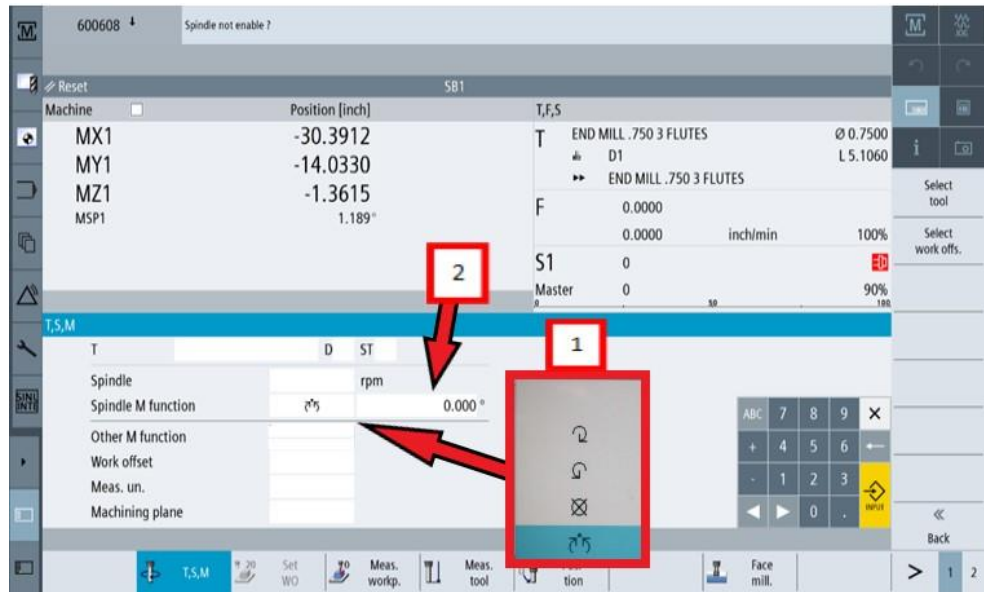

Enter ATC or Swivel Head Service mode:

Hold "SPINDLE STOP" and then press "FEED START" three times in rapid succession FEED START button will flash green indicating in ATC Service mode and a message will display at the top of the screen as shown:

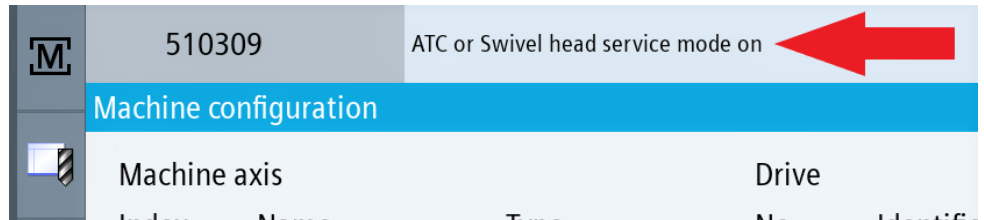

Exit ATC or Swivel Head Service Mode

Press "FEED STOP" or "RESET" one time – To exit out of Service Mode FEED START button will stop flashing

Control of ATC arm:

Press and hold "ARM" button and then quickly bump either the "-" or "+" button to get the arm to move in either direction. You can quickly press either the plus or minus button and have the arm move either direction a short distance or "bump" it a little either way. A longer press of the button while get it to move further while a solid holding of the button will have the arm move to the next operation position either home or tool change.

Manual Spindle Tool Clamp/Unclamp:

Under manual ATC control press unclamp button to let the arm remove a tool from the spindle. Press Clamp to have the spindle hold a tool as the arm moves away from the spindle.

4.3.5 Example of Service Mode in Use

The idea for this section is to document a real event that needed to use the Service Mode feature of the controller to solve the problem. You will manually complete all steps listed in section 4.3.2 ATC Tool Change Cycle.



Photos above show a mill where the E-Stop was hit just as a tool was being changed automatically. The photo from the underside shows the arm was just touching the tool holder. However, arm was not completely engaged with the tool holder, so the tool needed to be removed manually before the mill could be restarted. This is a case where the Service Mode will solve the problem.

Simple solution is to advance the spindle by pressing and holding "ARM" and then press "+" with enough time to have the arm make solid contact with the spindle. The arm is now in the proper position for a tool change. We need to remove either one or two tools with the arm.



Press the green tool unclamp button "Press Unclamp/Release Clamp" to unclamp the tool from the spindle so the arm can remove it. Forward the arm away from the spindle by holding the "ARM" button and short taps on the "+" button to get the arm in a place where you can manually remove the tool(s).

The plunger has a strong spring which needs to be held flush with the arm to manually remove the tool(s).



You can now forward the arm back to home position using "ARM" and a longer bump of the "+" button to locate the arm at home position. To finish ATC cycle, press the Clamp green button on the spindle to get the tool holder in the clamp mode and move the arm forward to home.

This example situation was cleared using the ATC or Swivel Head Service Mode.

Home Position

This is just one example of how the ATC or Swivel Head Service Mode can be used. If the arm had not made contact with the tool holder, it is possible to reverse the arm to the home position, raise the ATC Pot, and reset the machine.

Tool Change Position

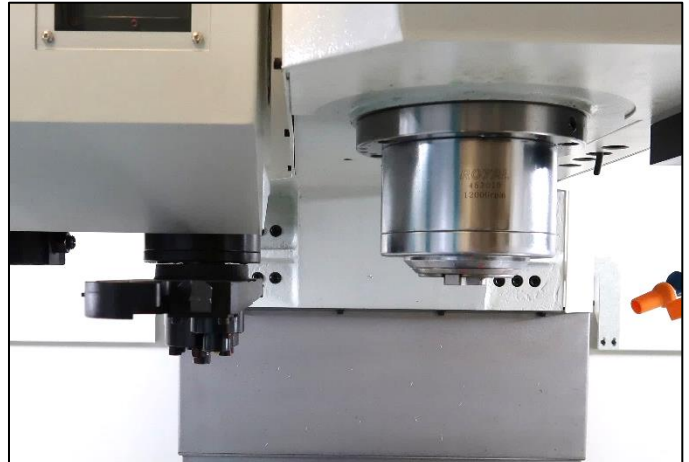

Tool(s) in the Grippers

Note: Make sure you have read and understand the whole section on ATC or Swivel Head Service Mode before removing tools from the ATC arm, section 4.3.5.

This covers another possible use of the Service Mode similar to above except with the addition of a tool or tools in the grippers.

If you have a tool or tools in the grippers, you must manually remove them before returning the controller to automatic operation. Remove the physical tool(s) manually by pressing the plunger on the arm while holding the tool and remove it when the spring tension is released. Then highlight the tool or tools still shown to be in the tool table either using one or both grippers and press "Unload" to remove the tool(s) from the table as shown to the right.

Loc.	Type	Tool name	ST	D	H	Length	∅		1	2	CTS
		.375 3FL CARBIDE EM	1	1	0	3.9092	0.3760		3	∅	∅
		.25 DRILL	1	1	0	6.4296	0.2500	118.0	∅	∅	∅
1		.500 3FL CARBIDE EM	1	1	0	4.1608	0.5003		3	∅	∅
2		Spot-Chamfer .375X90	1	1	0	3.3350	0.3750	90.0	∅	∅	∅
3		CALIBRATION TOOL	1	1	0	1.9460	0.4890		∅	∅	∅
4		3D_PROBE	1	1	0	7.3924	0.2332		∅	∅	∅
5		EDGE_FINDER_200_IN	1	1	0	5.5000	0.2000		∅	∅	∅
7		.75 3FL Course Rougher E/W	1	1	0	5.1008	0.7500		3	∅	∅
9		FACEMILL 3.0 KENNAMETA	1	1	0	3.8151	3.0000		8	∅	∅
10		.1875 3FLT CARBIDE EM	1	1	0	5.0979	0.1875		3	∅	∅
11		6MM 2FL BALL	1	1	0	4.7230	0.2360		2	∅	∅
12		.375 2FL BALL	1	1	0	3.8149	0.3750		2	∅	∅

The tool table to the right shows no tools in the grippers which should be confirmed before exiting ATC or Swivel Head Service Mode.

Loc.	Type	Tool name	ST	D	H	Length	∅		1	2	CTS
		.375 3FL CARBIDE EM	1	1	0	3.9092	0.3760		3	∅	∅
1		.500 3FL CARBIDE EM	1	1	0	4.1608	0.5003		3	∅	∅
2		Spot-Chamfer .375X90	1	1	0	3.3350	0.3750	90.0	∅	∅	∅
3		CALIBRATION TOOL	1	1	0	1.9460	0.4890		∅	∅	∅
4		3D_PROBE	1	1	0	7.3924	0.2332		∅	∅	∅
5		EDGE_FINDER_200_IN	1	1	0	5.5000	0.2000		∅	∅	∅
7		.75 3FL Course Rougher E/W	1	1	0	5.1008	0.7500		3	∅	∅
9		FACEMILL 3.0 KENNAMETA	1	1	0	3.8151	3.0000		8	∅	∅
10		.1875 3FLT CARBIDE EM	1	1	0	5.0979	0.1875		3	∅	∅
11		6MM 2FL BALL	1	1	0	4.7230	0.2360		2	∅	∅
12		.375 2FL BALL	1	1	0	3.8149	0.3750		2	∅	∅

4.4 Set Tool Change Height

There are instructions on our website that will explain how to set the tool change height. There are special tools required along with the procedure. Search for VMCsi – Set Orientation Angle & Tool Change Height on our Dozuki website trakmstsupport.dozuki.com for further information.



4.5 Tool Management Alarm Codes

These alarms are generated from Siemens Tool Management system. These issues are found when the Siemens system get a command that does not work properly with the Tool Management. Siemens software monitors the tool table and the removal and replacement of worn out tools. There is also a system to manage the dynamic reallocation of the ATC storage location as the tools change positions in the magazine. More information is available on the controller by pressing the “i” or help button.

Alarm Number	Tool Management Description
6401	Tool change not possible, no free location in the magazine.
6402	Tool change not possible, magazine number does not exist.
6403	Tool change not possible, specified magazine location does not exist.
6404	Tool change not possible because the tool is not available or cannot be used.
6405	Command has invalid PLC acknowledgement parameter.
6406	PLC acknowledgement missing.
6407	Tool is to be set down at a location that does not meet the requirements for loading.
6410	One cutting edge of the monitored tool has reached a prewarning limit.
6411	One cutting edge of the monitored tool has reached a prewarning limit.
6412	One cutting edge of the monitored tool has reached a monitoring limit.
6413	One cutting edge of the monitored tool has reached a monitoring limit.
6421	No free location for tool in the magazine.
6422	Tool motion is not possible because the magazine has not been defined.
6423	Tool motion is not possible because no location in the magazine.
6424	Tool motion is not possible because tool not available or cannot be used.
6425	Tool motion is not possible because tool cannot be placed at the specified location in the magazine.
6430	Workpiece counter: Overflow in table of monitored cutting edges.
6431	Function not permitted because TOOLMAN / TOOLMAN monitoring not activated.
6432	Function cannot be executed because there is no tool in the spindle.
6433	System variable not available for active tool management.
6436	The command cannot be programmed.

Alarm Number	Tool Management Description
6438	Inconsistent data change not permitted.
6441	Writing of \$P_USEKT not allowed.
6450	Tool change not possible because magazine-location number is not valid.
6451	No buffer magazine defined.
6452	Tool holder number / spindle number not defined.
6453	No relationship defined between tool holder number / spindle number and buffer magazine.
6454	Neither spindle nor buffer location has a distance relationship.
6460	Command can only be programmed for tools.
6462	Command can only be programmed for magazines.
6464	Command cannot be programmed for the actual multitool distance coding.
6924	Tool data changed for program text.
17001	No more memory for tool magazine data.
17020	Illegal array index 1
17050	Impermissible value
17160	No tool selected
17180	Illegal D Number.
17181	D no. not known.
17182	Illegal additive offset number.
17188	The D number specified in the channel TO unit is not unique.
17189	D number is not unique.
17191	Unknown tool identifier.
17192	No further replacement tools possible.
17193	The active tool is not longer in the tool holder.
17194	No suitable tool found.
17200	Tool cannot be deleted.
17202	Magazine data cannot be deleted.
17212	Manual tool must be changed.
17214	Remove manual tool from tool holder.
17215	Remove manual tool from buffer.
17216	Manual tools must be changed.
17218	Tool cannot become a manual tool.
17220	Tool does not exist.
17224	It is not possible on this system to select tool offsets for tool of the specified tool type.
17230	Duplo no. already assigned.
17240	Invalid tool definition.
17241	Illegal adapter definition.
17242	Manual tool cannot be set, as the function is not active.
17250	Invalid magazine definition.
17255	Magazine location hierarchies have been deleted.
17260	Invalid magazine location definition.
17262	Incorrect tool-adapter assignment.
20150	PLC terminates the interrupted command.
20160	PLC can terminate only incorrectly aborted commands.
22066	Tool motion not possible because specified tool is not in magazine.
22067	Tool change not possible because no tool ready for use in the tool group.
22068	No tool ready for use in the tool group.
22069	No tool ready for use in the tool group.
22070	Change tool into magazine. Repeat data backup.

Alarm Number	Tool Management Description
22071	Tool has the status "active" in an "inactive" wear group.
400601	Incorrect configuration of loading points.
400602	Incorrect spindle configuration.
400603	Incorrect turret configuration.
400604	Set changed with M06 in machine data.
410141	Number of loading points too high.
410142	Number of tool holders too high.
410143	Number of turrets too high.
410151	Magazine data for tool management missing in PLC.

4.6 Specialty Tools

4.6.1 ATC Tool Remover

Included with your VMCsi purchase is a special tool designed to help you remove a machine tool holder from a pot. There are several reasons you might need to remove a tool holder manually. This is a special pry bar that fits between the pot and the rim of the tool holder. There are a couple of style of this tool available but they are similar to the tool shown in the photo to the right.



Operation of the tool is very simple; you pry the tool holder away from the pot. Use caution because many tools are sharp in the tool holder. Be prepared to hold the weight of the heavy tool holder in your hand. You don't want to drop it.

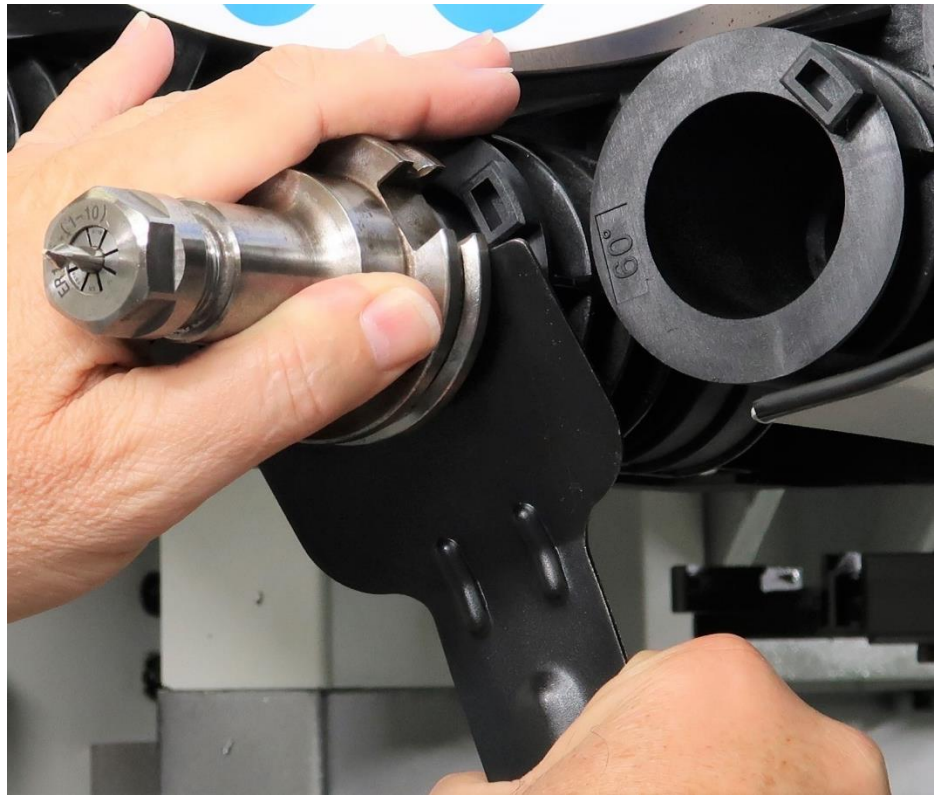

5.0 Maintenance and Replacement

5.1 Maintenance

5.1.1 How to Clean the Touchscreen & Pendant

The pendant is designed for low maintenance operation. Nevertheless, you must regularly clean the pendant.

Safety Notes:

1. Turn power off when cleaning the pendant.
2. Do not clean the device using compressed air or steam jets because they can damage it.

Clean only the front panel with a soft cloth moistened with water or mild cleaning agent. Spray the cleaning agent or water on to a cleaning cloth. Do not spray anything directly on the front panel. Never use caustic solvents or abrasive cleaners.

Use dry cloth to clean the backside of the pendant.

5.1.2 Periodic Maintenance

In order to prevent unwanted items, dirt or liquids entering the mill, regularly check the mill for the following:

1. Ensure that all the housing screws are in place and tight, door safety interlock is working.
2. Check all over the housing for damage, breakage, or missing parts (i.e. side window removed for access and left off)
3. Check for damage to the cable cover, cable entry and hoses

5.1.3 Tool Change Pots – Cleaning & Visual

The condition of the Tool Change Pots is very important for mill operation. Damaged pots should be inspected right after a problem with a tool change, dropped tool, or other problem. They will also be inspected on a routine basis.

Pots are not repairable or serviceable. If they show damage from some accident, the pot involved should be inspected and replaced if damaged. In the case a worn-out pot is found, they all should be inspected. They will not necessarily wear out at the same time, but advisable to check them all. The correct diameter of the opening circle must be maintained, if the circumference of the opening that orients the tool is damaged or noticeably out of round, it should be replaced see figure 5.1.3a. The tool



Figure 5.1.3a Circumference Check

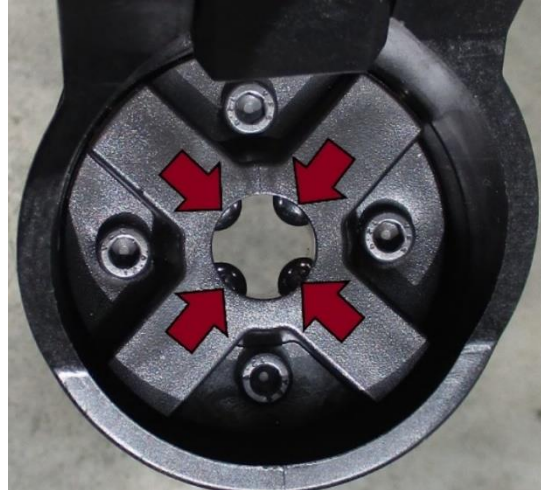

Figure 5.1.3b Tool Retainers

retainers are spring mounted ball bearings see figure 5.1.3b. If the bearings are damaged or the springs are too weak to hold a tool, the pot should be replaced. There are several other inspection points on the pots. The shim should be checked for damage. The pin should be able to rotate freely; however, if either pin anchor holes are out of round, replace the pot. The same test applies for the two anchor holes shown in figure 5.1.3c

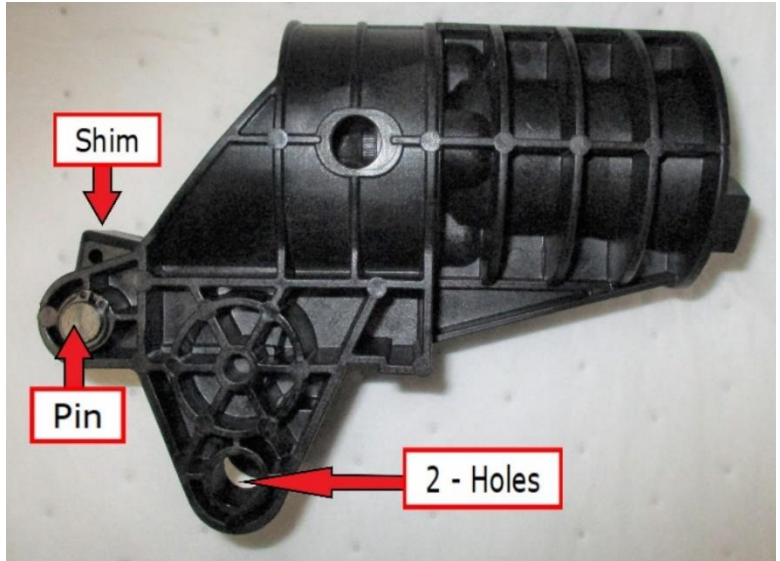

Figure 5.1.3c Inspection Points

5.1.4 Tool Clamp/Unclamp – Checking Adjustment

There is a 5mm gap between the clamp riser and the top of the spindle. Air pressure facilitates the tool changes which should not require any adjustment.

5.2 Diagnostic I/O Screens

TRAK has a custom screen monitoring a wide range of data easily accessible on the pendant. The screens are filled with flags that display "TRUE" or "FALSE". Display I/O parameters screen display the status of inputs and outputs. TRUE means that the I/O status is 1 and FALSE means I/O status is 0. FALSE does not mean that I/O is not working, it means that the current status of the I/O is 0. The screen is found by pressing the left VSK "Diag" button, from "Diag" page 1 press "TrakMT Diagnostic" button on the far right side of the HSK. The operator may scroll down to find various data listed below.

5.2.1 4th Axis & Automatic Tool Changer I/O

This screen reports many 4th axis and auto tool changer inputs as well as 4th axis and ATC outputs.

The screenshot shows the 'Display I/O Parameters' screen with the following data:

4th Axis Inputs		4th Axis Outputs	
axis4Ref	FALSE	axis4ClampSol	FALSE
axis4Released	FALSE		
axis4Clamped	FALSE		
ATC Inputs		ATC Outputs	
ATCarmHomedSensor	FALSE	magazineRotFwd	FALSE
magazineCounterA	TRUE	magazineRotRev	FALSE
magazineHome	FALSE	armFwd	FALSE
toolReleasePB	FALSE	armRev	FALSE
ATCarmOverloaded	FALSE	toolRelease	FALSE
toolAtClamp	TRUE	potToDown	FALSE
toolAtRelease	FALSE	potToUp	FALSE
magazineOverloaded	FALSE		
ATCpotAtUp	TRUE		
ATCpotAtDown	FALSE		
ATCarmBrakedSensor	FALSE		
ATCarmUnclamped	TRUE		

5.2.2 Auxiliary Inputs/Outputs

Scroll down to find safety and auxiliary inputs and outputs.

The screenshot shows the 'Display I/O Parameters' screen with the following data:

Aux Inputs		Aux Outputs	
washPumpOverloaded	FALSE	coolantPump	FALSE
CTSpumpOverloaded	FALSE	CTSpump	FALSE
spindleCoolerAlarm	TRUE	washPump	FALSE
coolantPumpOverloaded	FALSE	chipMotorFwd	FALSE
chipConveyorOverloaded	FALSE	chipMotorRev	FALSE
AirReady	TRUE	airBlast	FALSE
		spindleFan	FALSE
		workLight	TRUE
Guard Inputs		Guard Outputs	
doorAtOpen	TRUE	doorSol	FALSE
doorAtLock	TRUE		

5.2.3 Hand Held Unit (HHU) or EHW

Scroll down to find EHW and limit switch inputs and outputs.

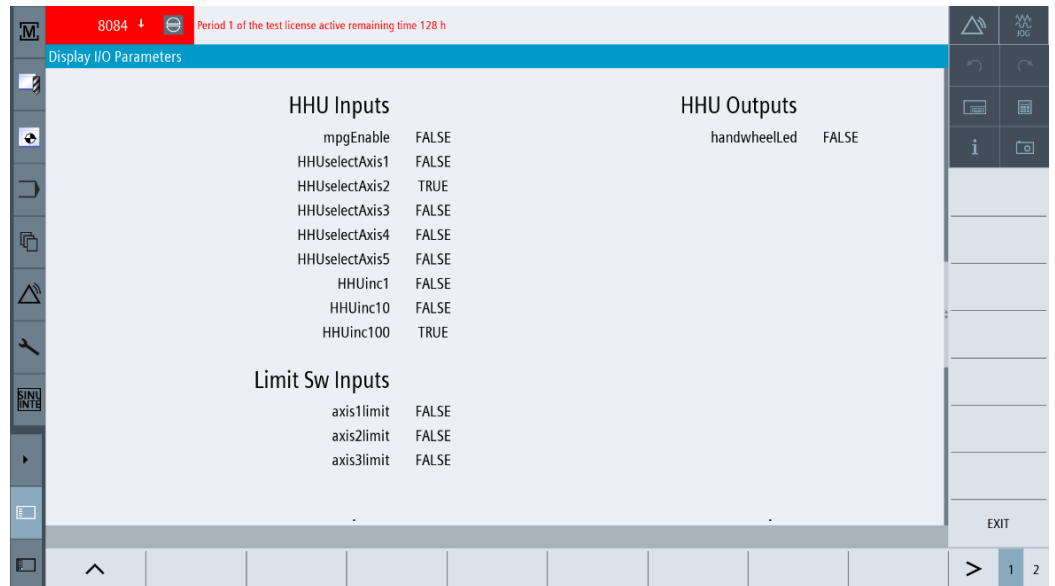

5.2.4 Lubrication, E-Stop, Sinamics Controls

Scroll down to find lube, control and e-stop inputs and outputs.

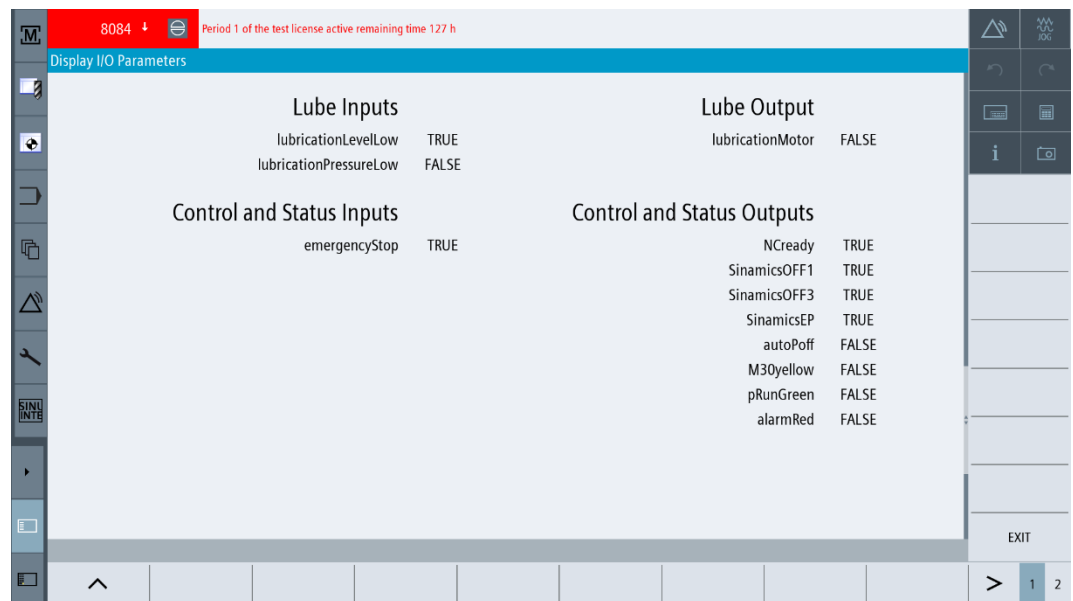

5.2.5 Testing and Spare Inputs

Scroll down to the bottom of the list has the inputs and outputs designed for future use.

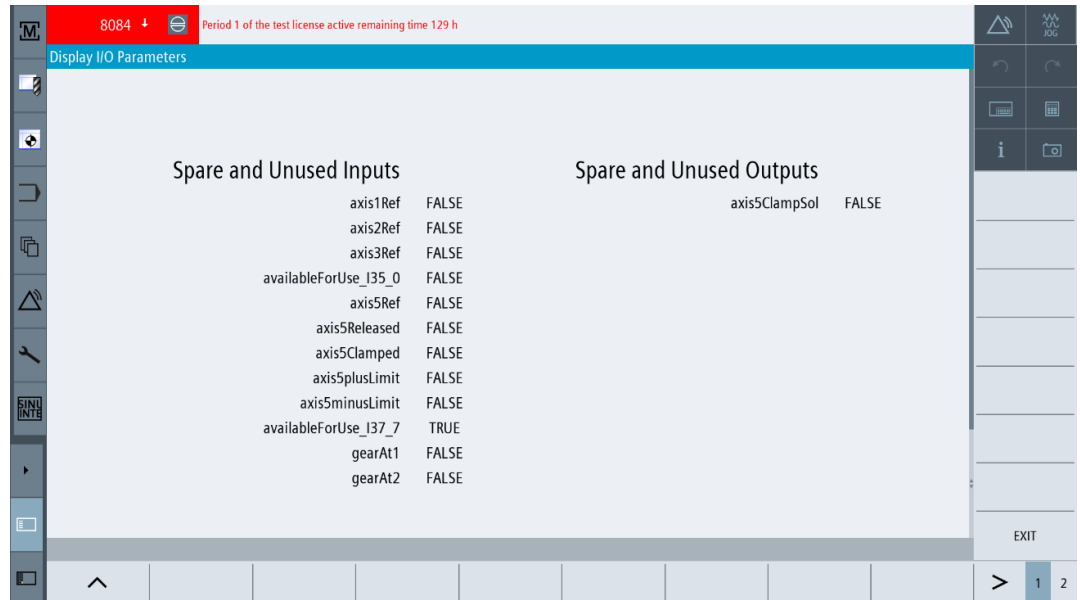

5.2.6 Automation Ready Inputs/Outputs

Scroll down to find Automation Ready inputs and outputs.

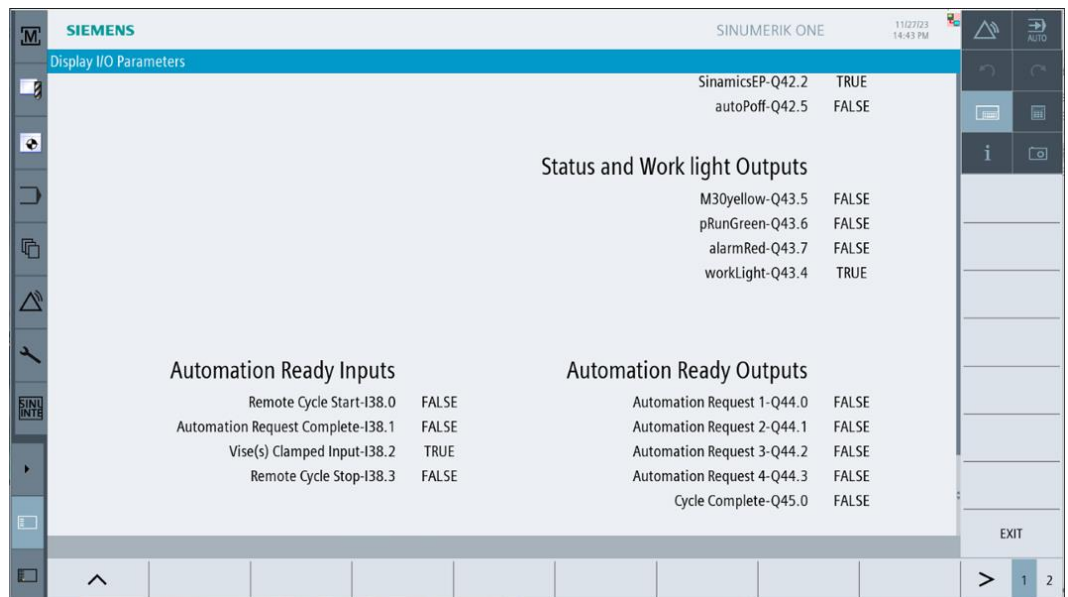

5.3 Alarm and Messages

5.3.1 Automation Ready Alarms

#	Description	Definition
700247	Vise(s) Unclamped	<ul style="list-style-type: none"> This Alarm is intended to be used to identify when a vise or vises are in an unclamped state. This Alarm will prevent the machine from running a program. This Alarm can be disabled in the TRAK Option screen. If enabled via the TRAK Option screen. This alarm will be displayed when the Vise Clamp input is Low (0V) on the I38.2 input.
700959	Vise(s) Unclamped	<ul style="list-style-type: none"> This Message will appear in Jog mode to indicate that the vise or vises are in an unclamp state. The machine will still be allowed to be manually moved while this message is active. This input can be disabled in the TRAK Option screen
700943	Waiting for Automation Request 1 to Finish	<ul style="list-style-type: none"> When triggered by an M22, this message will appear and stop the axis and spindle while it waits for the Automation Finish input (I38.1) to go High (24V). This message will be displayed only when the "Wait for Finish Input on Automation Request 1" is Enabled in the TRAK Option screen.
700944	Waiting for Automation Request 2 to Finish	<ul style="list-style-type: none"> When triggered by an M24, this message will appear and stop the axis and spindle while it waits for the Automation Finish input (I38.1) to go High (24V). This message will be displayed only when the "Wait for Finish Input on Automation Request 2" is Enabled in the TRAK Option screen.
700945	Waiting for Automation Request 3 to Finish	<ul style="list-style-type: none"> When triggered by an M26, this message will appear and stop the axis and spindle while it waits for the Automation Finish input (I38.1) to go High (24V). This message will be displayed only when the "Wait for Finish Input on Automation Request 3" is Enabled in the TRAK Option screen.
700946	Waiting for Automation Request 4 to Finish	<ul style="list-style-type: none"> When triggered by an M28, this message will appear and stop the axis and spindle while it waits for the Automation Finish input (I38.1) to go High (24V). This message will be displayed only when the "Wait for Finish Input on Automation Request 4" is Enabled in the TRAK Option screen.
701257	Automation Request 1 Active	<ul style="list-style-type: none"> This message will be displayed only when the "Wait for Finish Input on Automation Request 1" is disabled in the TRAK Option screen. This message will be displayed when the M22 has been activated along with turning ON output (Q44.0). M23 will turn OFF (Q44.0) and clear this message. Pressing the the E-stop or the MCP Reset button will also turn OFF Q44.0 and clear this message.
701258	Automation Request 2 Active	<ul style="list-style-type: none"> This message will be displayed only when the "Wait for Finish Input on Automation Request 2" is disabled in the TRAK Option screen. This message will be displayed when the M24 has been activated along with turning ON output (Q44.1). M25 will turn OFF (Q44.1) and clear this message. Pressing the E-stop or the MCP Reset button will also turn OFF (Q44.1) and clear this message.
701259	Automation Request 3 Active	<ul style="list-style-type: none"> This message will be displayed only when the "Wait for Finish Input on Automation Request 3" is disabled in the TRAK Option screen. This message will be displayed when the M26 has been activated along with turning ON output (Q44.2). M27 will turn OFF (Q44.2) and clear this message. Pressing the E-stop or the MCP Reset button will also turn OFF (Q44.2) and clear this message.
701260	Automation Request 4 Active	<ul style="list-style-type: none"> This message will be displayed only when the "Wait for Finish Input on Automation Request 4" is disabled in the TRAK Option screen. This message will be displayed when the M28 has been activated along with turning ON output (Q44.3). M29 will turn OFF (Q44.3) and clear this message. Pressing the E-stop or the MCP Reset button will also turn OFF (Q44.3) and clear this message.

6.0 4th Axis Option

TRAK manufactures a 4th axis option that can be retro-fitted onto a TRAK VMCSi at any time after its initial purchase. See figure 7.0.

The 4th axis model's key features include:

- The unit doesn't require air.
- The unit is compact.
- The unit is sealed and lubricated for 20,000 hours of operation therefore no maintenance is required.

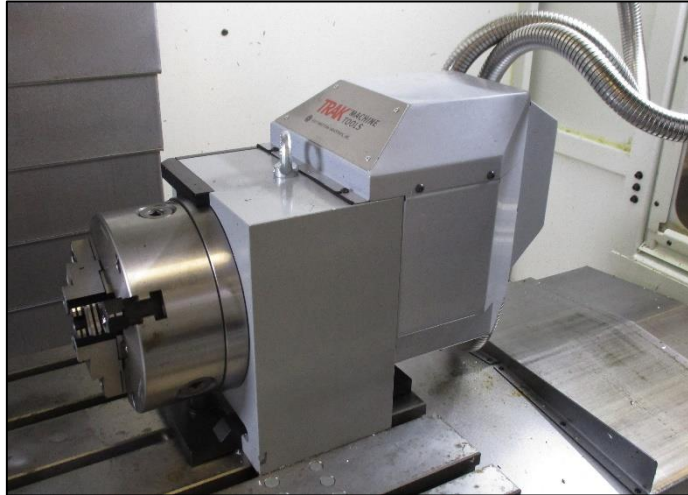

Figure 7.0 - 4th Axis Option

6.1 Start and Stop 4th Axis Operation

Once the 4th Axis Option is installed in your machine, it is available to use whenever it is needed. When either installing the option for the first time or reinstalling, the encoder and power cables need to be connected to the two connectors on the inside ceiling of the machine as shown in section 7.3 before enabling the 4th axis. The encoder and power cables need to be disconnected before disabling the 4th axis. Refer to 4th Axis Installation Checklist section 7.4 for a detailed explanation for enabling and disabling the 4th axis.

TRAK has a customized screen available for enabling and disabling the 4th axis operation. To access the screen, at the upper right corner of the display, press [M], press "SETUP" from the left VSK menu bar then press "TrakMT Options" from the HSK as shown below:



Before changing the status of the 4th Axis, always press "E-Stop".

The current 4th axis option will be displayed on the top line of the screen. To change 4th axis status, press the "Fourth Axis" button on the right VSK, see figure 7.1a.

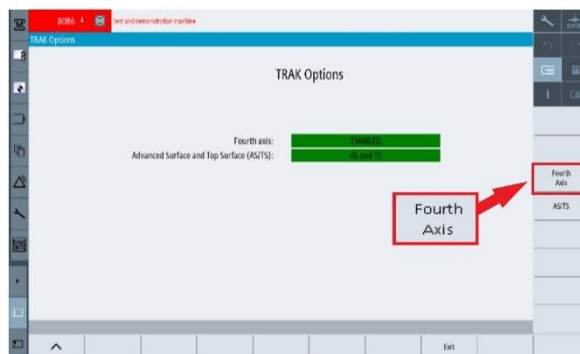

Figure 7.1a

The 4th Axis status is displayed on the top line of the 4th Axis Option screen. To change the status, press the second line which displays both "Enable" and "Disable" from the drop down menu. Press your selection and then "Accept", see figure 7.1b.

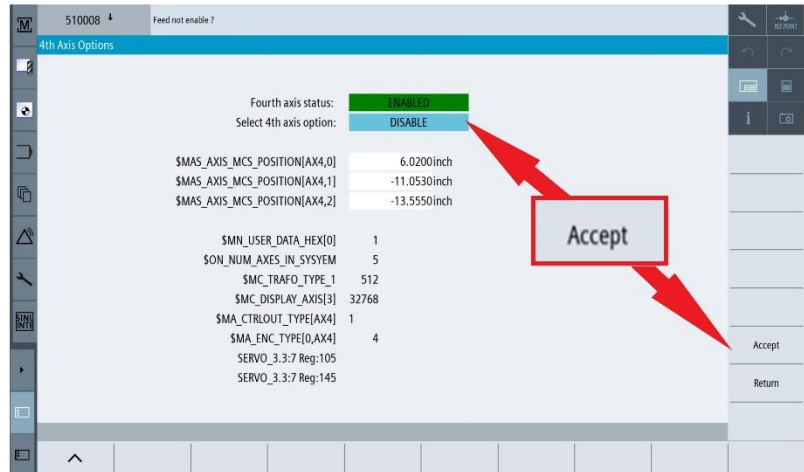

Figure 7.1b

6.2 4th Axis Specifications

Feature	Specification
Spindle Diameter	8.07" (205mm)
Chuck Diameter	7.874" (200mm)
Overall Height of 4 th Axis	13.82" (351mm)
Centerline Height of Spindle	6.30" (160 mm)
Minimum Resolution of System	0.001°
Maximum RPM	40
Repeatability	+/- 2 arc seconds
Indexing Accuracy	25 arc seconds
4 th Axis Weight	190 lbs (86 Kg)
4 th Axis Keyway Size	18 mm
Max distance between 4th axis chuck face & tailstock with center*	VMC7si – 14.14" (360mm) VMC10si – 22.70" (580mm) VMC12si – 29.86" (758mm) VMC14si – 41.67" (1058mm)

* Chuck and adapter plate can be removed to add up to 4.65" (113mm) of additional distance. Chuck and adapter plate feed-through hole is 2.28" (58mm).

6.3 Mounting the 4th Axis

The images below demonstrate how the 4th axis unit mounts to the VMCsi table with figure 7.3a showing the side view. Figure 7.3b shows the clamping block. Figure 7.3c shows the complete assembly with the cable connections. The 4th axis unit has an eyebolt attached to the top of the unit for lifting purposes as shown in the figure 7.3c. Figure 7.3d shows the optional tailstock.

The 4th axis unit requires two cables to be connected and disconnected each time you add or remove the unit from the machine. See figure 7.3e to show the cables connected. Do not install the 4th axis or connect the cables before reading the 4th Axis Installation Checklist section 7.4. When either installing the option for the first time or reinstalling, the encoder and power cables need to be connected to the two connectors on the inside ceiling before enabling the 4th axis. The encoder and power cables need to be disconnected before disabling the 4th axis. Make sure the cables are securely fastened and locked in place. Connectors have covers to protect electronics when option not mounted.

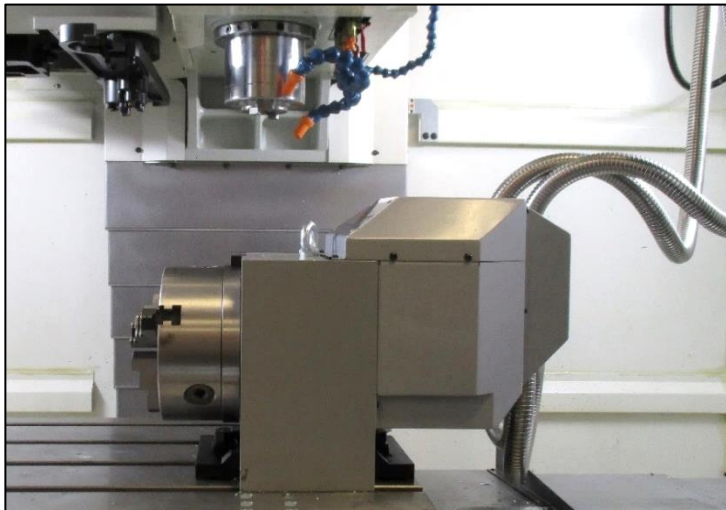

Figure 7.3a –4th Axis Side View Mounted on VMCsi Table

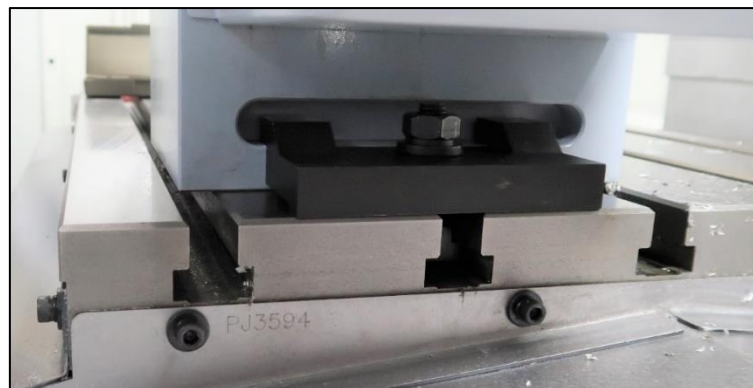

Figure 7.3b – Clamping Block



Figure 7.3c – 4th Axis Option mounted on VMCsi showing cable routing



Figure 7.3d – Tailstock Option

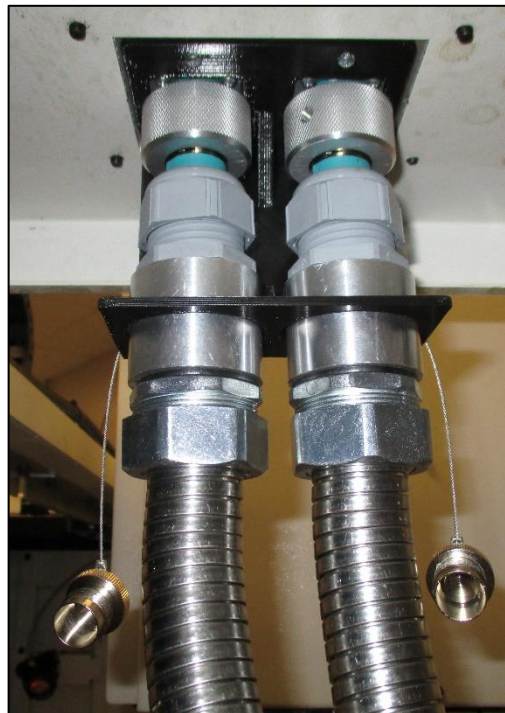
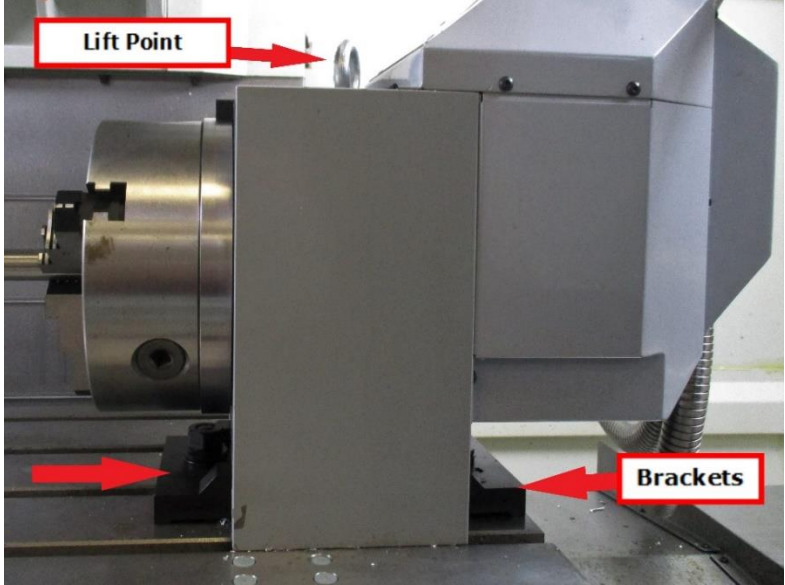



Figure 7.3e – 4th Axis Connectors

6.4 Installation Checklist of the 4th Axis

Use this checklist to add and setup the 4th Axis on the VMCsi. This is for FST or customers to be able to add the 4th Axis as needed.

Note: - Steps assume the option was installed at the factory.

4 th Axis Installation Checklist	
<input type="checkbox"/>	1. Turn off power to the machine when installing or removing 4 th axis unit.
<input type="checkbox"/>	2. Safety Warning!! Install the 4 th Axis unit on the table using the lift point with a crane as shown. Be careful placing the heavy unit on the table. Attach T bolts, nuts, and brackets loosely until aligned in a later step.
	
<input type="checkbox"/>	3. Connect cables after removing caps in the inside right side ceiling connectors.
	
<input type="checkbox"/>	4. Turn power on to configure the 4 th Axis.

4th Axis Installation Checklist

- 5. Align the 4th Axis parallel to table. Use a dial indicator by sweeping the length of the known value:

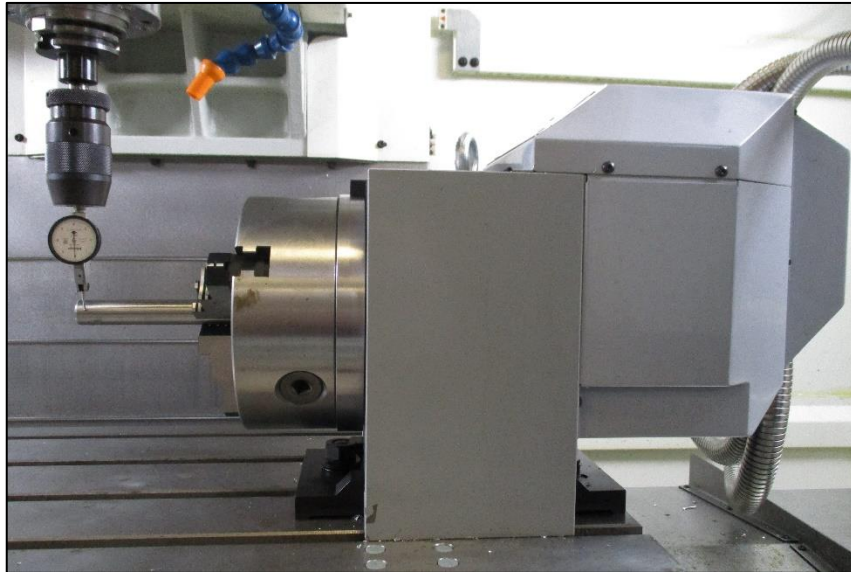

With the dial indicator staying constant during the sweep to show the 4th axis is parallel to table:

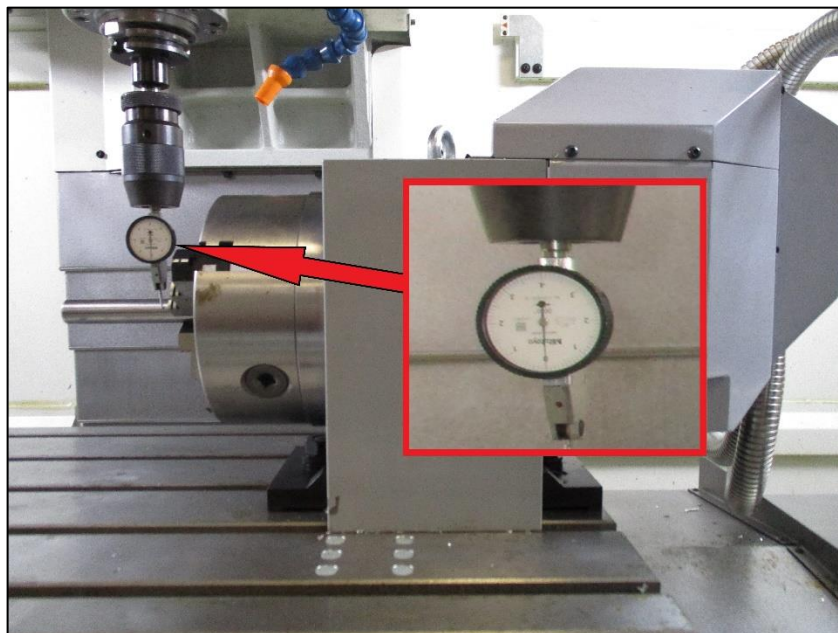

Adjust 4th Axis and retest as needed to get it parallel to the table as measured with the dial indicator.

- 6. When the 4th Axis is parallel to the table, tighten mounting nuts.

4th Axis Installation Checklist

- 7. To find the X axis, touch an edge finder off the front of the face plate. NOTE: Don't forget to subtract half the diameter of your edge finder. Make a note of the number MX1 from the screen.

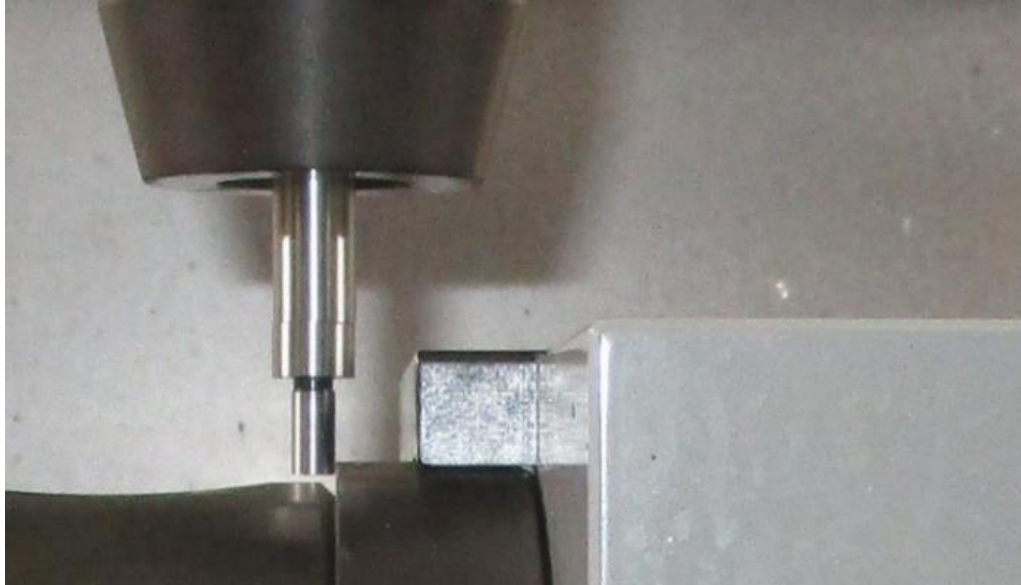

- 8. Use your edge finder and touch the front of the known stock value: NOTE: Don't forget to subtract half the diameter of your edge finder and also half the diameter of your known stock value. Make a note of the number in MY1 from the screen.

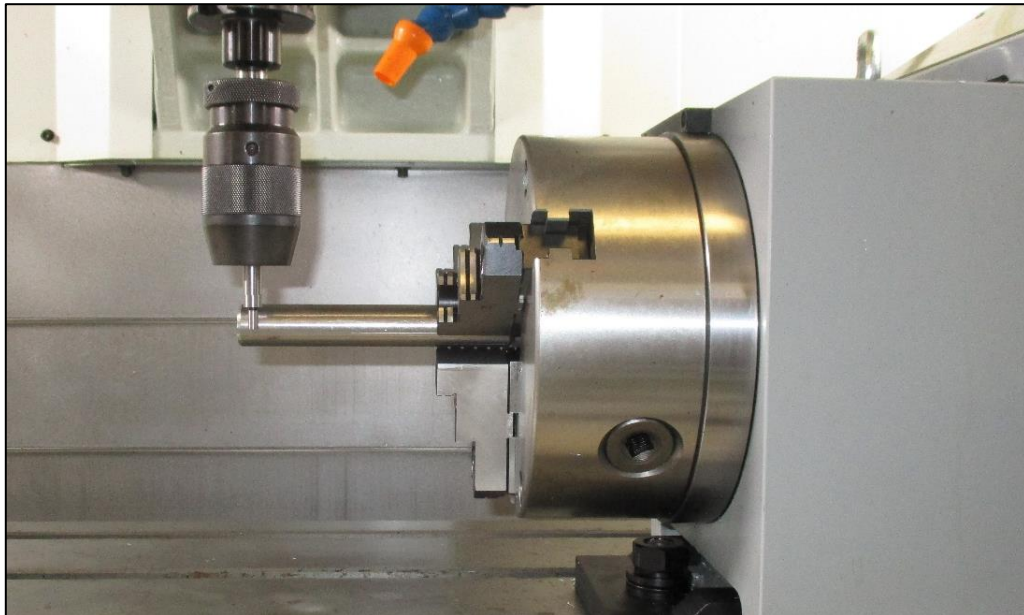

4th Axis Installation Checklist

- 9. Set the nose of the spindle to touch the top of your known stock value. NOTE: Add half the diameter of your known stock. Make a note of this number in MZ1 from the screen.

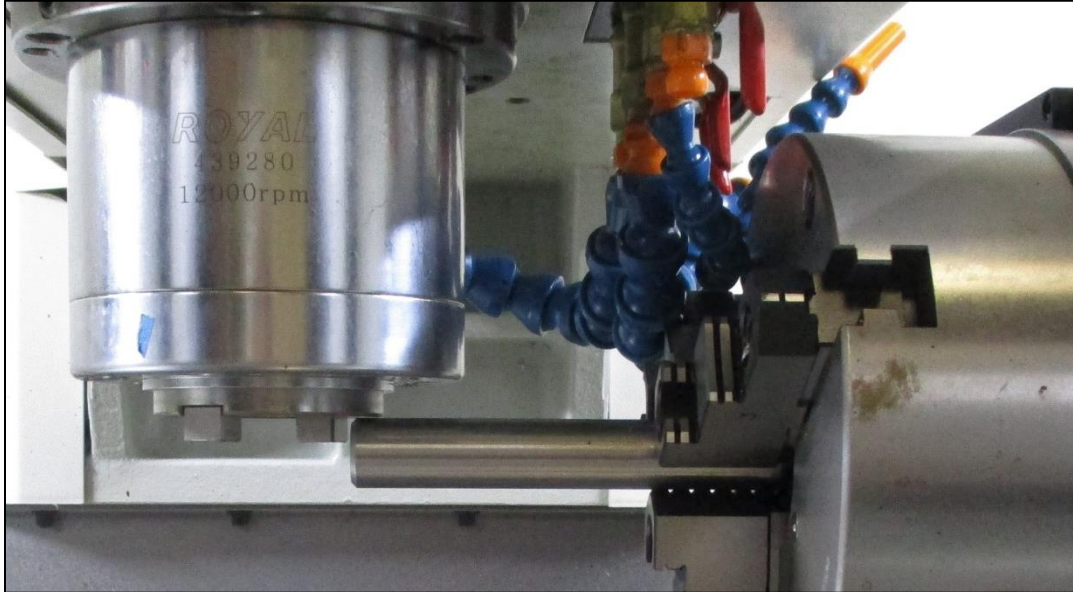

- 10. This step records the three axis values you noted. To access the axis information screen, at the upper right corner of the display, press [M], press "SETUP" from the left VSK menu bar then press "TrakMT Options" from the HSK as shown below:



Press "E-Stop".

The TRAK Options screen will display the current status of the 4th Axis as well as the Advanced Surface and Top Surface (AS/TS) options. Press "Fourth Axis" from the right VSK.

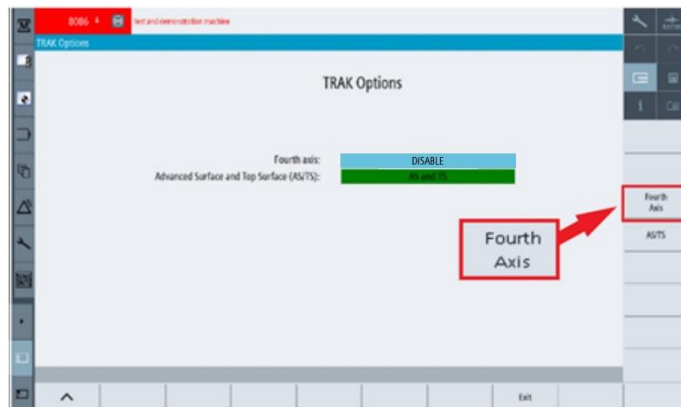

You will now see the 4th Axis Options screen. The Fourth axis Enable/Disable status is on the first line. The 4th Axis should be disabled at this point. Press the drop-down menu on the second

4th Axis Installation Checklist

line and select "Enable". Set X/Y/Z position using the values you noted above to record the 4th Axis location on the table. Highlight each axis one at a time and use the pop-up keypad to enter inputs for the three Axis then press "Accept" and "Return".

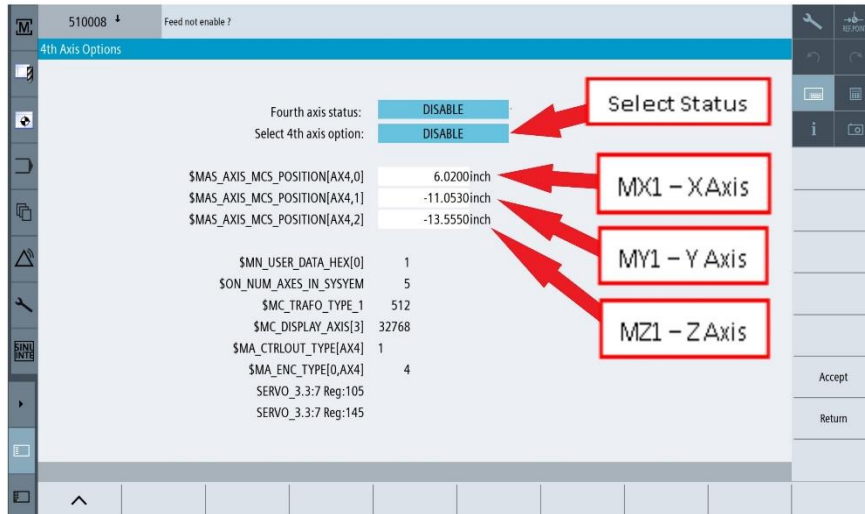

Caution: The screen will take any value, so double check your inputs.

The 4th Axis encoder and power cables should be connected to the ceiling connectors in the machine before enabling the option as shown in section 7.1. Refer to section 7.3 for details about how to connect the cables.

Note: When removing the 4th Axis from the mill, disconnect the cables before disabling the 4th Axis software.

Note: This procedure has to be redone for the X & Y axis each time the 4th axis has been moved or reinstalled.

- 11. Confirm that the 4th Axis has been referenced. When [Jog] and [Ref Point] buttons pressed, press [M]. Resulting screen should show a circle on left side of MA1.
- 12. Reboot machine to activate the settings.
- 13. Run the 4th axis test program called TEST_4th_AXIS.MPF. Program takes about 10 minutes or so to run.
Set your work coordinate to G55. Set your Y/Z zero for the center of the chuck. Set your X zero about 10" negative from the 4th axis chuck. The entire program will run with one tool and all motion will happen in the air.

6.5 Troubleshooting by Symptom

The following table lists a number of symptoms you may come across with the 4th axis unit.

Symptoms	Diagnostics or Possible Causes
4 th axis will not move when attempting to jog	<ol style="list-style-type: none">1. Confirm if the 4th Axis is enabled in TrakMT Options menu (Press Setup on left VSK then TrakMT Options on HSK. See Section 6.1 for details.)2. If a fault appears, double check all motor connections in the electrical cabinet. Check LED status on servo amp.
4 th axis is not coming back to zero	<ol style="list-style-type: none">1. Reset work zero.2. Motor encoder may not be reading correctly.
Cutter is chattering when cutting	<ol style="list-style-type: none">1. Make sure your setup is tight. Clamps on table, chuck and adapter plate, etc.2. Make sure the unit does not have excessive backlash
Parts are not accurate	<ol style="list-style-type: none">1. Possible programming error. Check your program.2. Make sure you have set your part zeros correctly.

6.6 4th Axis Chuck and Adapter Plate Removal and Replacement

The chuck that comes with the 4th axis unit fastens to an adapter plate, which in turn fastens to the spindle face of the unit. The chuck is held on to the adapter plate with (3) screws and the adapter plate is held on to the spindle face with (6) bolts. See figure 7.6.



Figure 7.6 – Chuck and Adapter Plate

Removal and Replacement Procedure

1. Remove the (3) screws that hold the chuck to the adapter plate.
2. Remove the (6) screws that hold the adapter plate to the spindle face.
3. Re-install the adapter plate and snug up the (6) screws that hold it to the spindle face.
4. Use an indicator to check the runout between the adapter and 4th axis unit. Tap the adapter plate until the runout is less than .0008". Try to get it as close as you can to zero.
5. Tighten the screws holding the adapter plate.
6. Install the chuck with (3) screws.
7. Use an indicator to check the runout between the chuck and 4th axis unit. Tap the chuck until the runout is less than .0008". Try to get it as close as you can to zero.
8. Tighten the (3) screws holding the chuck.

7.0 Introduction to Self-Service

The objective of this section of the manual is to allow the user of the VMCsi Control to resolve the majority of potential service problems.

This manual assumes that the user is not experienced with CNC troubleshooting and repairs. Special tools are not required for the procedures described in the manual.

Please see Section 3 for basic troubleshooting sections of the manual.

7.1 When You Have a Service Problem

SWI recommends that you consult this manual or our web site first. We also have a Dozuki site with detailed troubleshooting procedures <https://trakmtsupport.dozuki.com/>. Often it will be possible for you to resolve the problem yourself or isolate the problem to a particular cause.

Your next step is to contact the TRAK Customer Service Group for assistance.

7.1.1 Communication with the SWI Customer Service Group

TRAK Service Department Direct Line: (800) 367-3165
Web Address: www.trakmt.com

This phone line rings directly into the TRAK Customer Service Group. If a Customer Service Representative (CSR) is not available within the first few of minutes, your call is transferred into our voice mail system.

Our voice mail is continuously monitored. If you have an emergency, indicate this in your message. Our Service Voice Mail box number is 555.

TRAK Service Department Direct Fax Number: (310) 886-8029
Customer Service Group Hours: Monday - Friday 7:00 AM to 4:30 PM (PCT)
(TRAK observes a normal holiday schedule.)

7.2 Replacements

7.2.1 Exchange Program

SWI keeps in stock the major subassemblies required to resolve service problems. With very few exceptions, the part needed to resolve any given service problem is on the shelf and ready to ship. A little bit of troubleshooting on your part means that we can get the right part to you fast.

After replacing the failed unit with the replacement unit, simply put the failed unit in the same box that the replacement part came in and ship it back to us via UPS ground service.

This unique Exchange program gives our customers access to refurbished "like-new" subassemblies that have been brought up to current design revisions and go through the same QC procedures as our new

products. These high-quality replacement units are available at a fraction of the price of a new subassembly.

7.2.2 Return Material Authorization (RMA) Number

All shipments of replacement parts are accomplished through our Return Material Authorization (RMA) system. At the same time the CSR is diagnosing the problem and ordering the part, they will issue an RMA number that will allow us to efficiently process the return part.

TRAK Warranty Policy

Warranty

TRAK products are warranted to the original purchaser to be free from defects in workmanship and materials for the following periods:

Product	Warranty Period
New Siemens CNC	1 Year

The warranty period starts on the date of the invoice to the original purchaser from Southwestern Industries, Inc. (SWI) or their authorized distributor.

If a product, subsystem or component proves to be defective in workmanship and fails within the warranty period, it will be repaired or exchanged at our option for a properly functioning unit in similar or better condition. Such repairs or exchanges will be made FOB Factory/Los Angeles or the location of our nearest factory representative or authorized distributor.

Warranty Disclaimers

- This warranty is expressly in lieu of any other warranties, express or implied, including any implied warranty of merchantability or fitness for a particular purpose, and of any other obligations or liability on the part of TMT/SWI (or any producing entity, if different).
- Warranty repairs/exchanges do not cover incidental costs such as installation, labor, freight, etc.
- TMT/SWI is not responsible for consequential damages from use or misuse of any of its products.
- TRAK products are precision mechanical/electromechanical/electronic systems and must be given the reasonable care that these types of products require. Evidence that the product does not receive adequate Preventative Maintenance may invalidate the warranty. Excessive chips built up around ballscrews and way surfaces is an example of this evidence.
- Accidental damage, beyond the control of TMT/SWI, is not covered by the warranty. Thus, the warranty does not apply if a product has been abused, dropped, hit or disassembled.
- Improper installation by or at the direction of the customer in such a way that the product consequently fails, is considered to be beyond the control of the manufacturer and outside the scope of the warranty.
- Warranty does not cover wear items that are consumed under normal use of the product. These items include, but are not limited to: windows, bellows, wipers, filters, drawbars and belts.

F10302 | Rev: 012822